

**UNIVERSAL 320
UNIVERSAL 320 R**

Ⓝ DE	Bedienungsanleitung	10
Ⓝ EN	Operating Instructions	34
Ⓝ FR	Mode d'emploi	57
Ⓝ IT	Istruzioni per l'uso	82

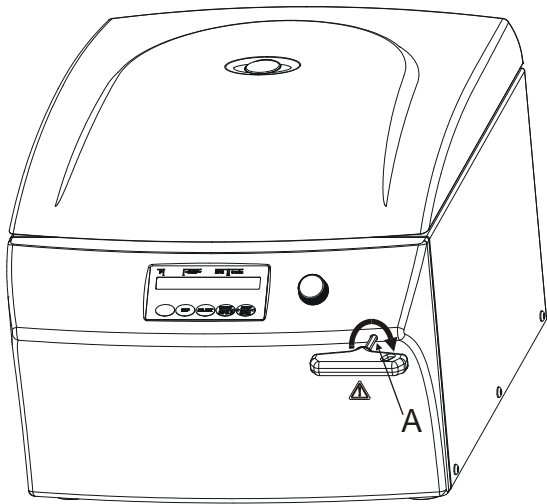

Fig. 1

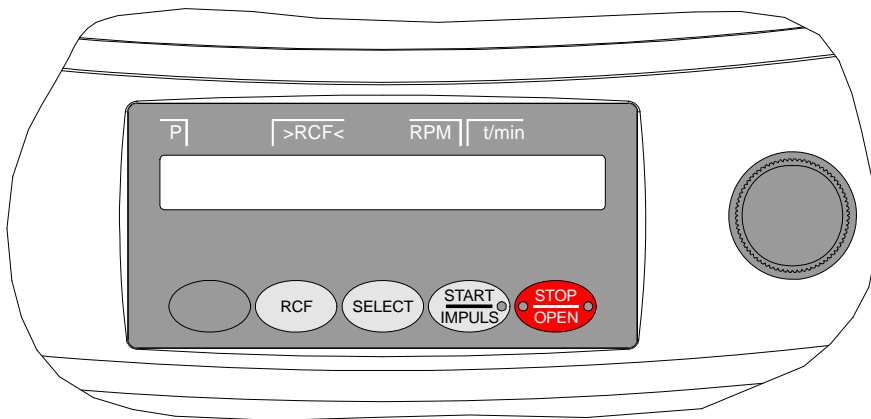

Fig. 2 UNIVERSAL 320

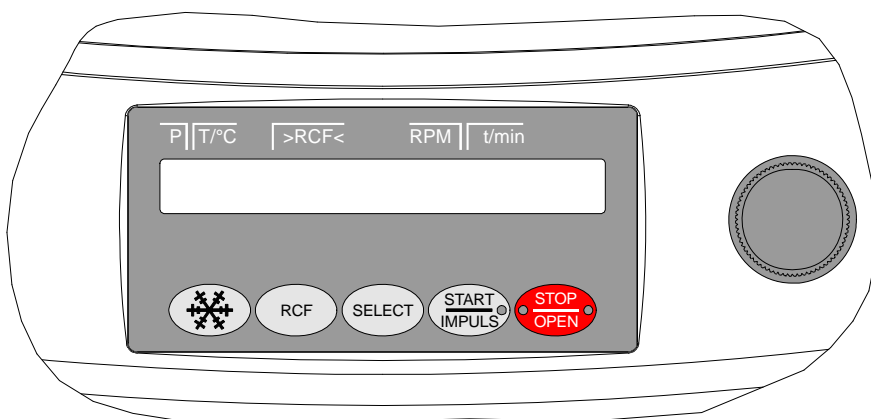

Fig. 3 UNIVERSAL 320 R

EG-Konformitätserklärung
EC Declaration of conformity
Déclaration de conformité CE
Dichiarazione di conformità CE

des Herstellers / of the manufacturer / du fabricant / del costruttore
Andreas Hettich GmbH & Co. KG • Föhrenstraße 12 • D-78532 Tuttlingen • Germany

Hiermit erklären wir in alleiniger Verantwortung, dass das bezeichnete Gerät, inklusive dem mit dem Gerät konformitätsbewertetem Zubehör laut Zubehörliste der technischen Dokumentation dieses Geräts, der Richtlinie über In-vitro-Diagnostika 98/79/EG entspricht.

We hereby declare under our sole responsibility that the designated device and its accessories, which are listed in the technical documentation for this device and whose conformity has been assessed together with the device, conform to the Directive 98/79/EC on in vitro diagnostic medical devices.

Par la présente, nous déclarons sous notre seule responsabilité que l'appareil désigné, incluant ses accessoires attestés conformes d'après la liste des accessoires de la documentation technique du dit-appareil, répond à la directive 98/79/CE sur le diagnostic In-vitro.

Si dichiara nella nostra sola responsabilità, che l'apparecchiatura indicata, comprensiva dei conformi accessori come da elenco della documentazione tecnica di questa apparecchiatura, risponde alle direttive per Diagnostica In-Vitro 98/79/CE.

Geräteart / Type of device / Type d'appareil / Tipo di apparecchio:

Laborzentrifuge / Laboratory centrifuge / Centrifugeuse de laboratoire / Centrifuga di laboratorio

Typenbezeichnung / Type designation / Désignation du type / Denominazione del tipo:

UNIVERSAL 320 / UNIVERSAL 320 R

Das Konformitätsbewertungsverfahren wurde nach Anhang III der Richtlinie 98/79/EG durchgeführt.

The conformity evaluation process was performed in accordance with appendix III of Directive 98/79/EC.

La procédure d'évaluation de la conformité a été réalisée conformément à l'annexe III de la directive 98/79/CE.

La procedura di valutazione di conformità è stata eseguita conformemente all'appendice III delle direttive 98/79/CE.

Folgende weitere europäische Richtlinien und Verordnungen wurden angewandt:

- Maschinenrichtlinie 2006/42/EG
- EMV-Richtlinie 2014/30/EU
- Niederspannungsrichtlinie 2014/35/EU
- RoHS II Richtlinie 2011/65/EU (ohne Beteiligung einer benannten Stelle)
- Verordnung (EG) Nr. 1907/2006 (REACH) (ohne Beteiligung einer benannten Stelle)

Angewandte Normen:

Gemäß Liste der angewandten Normen, die Teil der Produktakte ist.

The following additional European directives and ordinances have been applied:

- Machinery Directive 2006/42/EU
- EMC directive 2014/30/EU
- Low voltage directive 2014/35/EU
- RoHS II Directive 2011/65/EU (without involvement of a notified body)
- Ordinance (EC) No. 1907/2006 (REACH) (without involvement of a notified body)

Applied standards:

According to the list of applied standards, which is part of the product file.

Les autres directives et normes européennes suivantes ont été appliquées:

- Directive 2006/42/UE relative aux machines
- Directive CEM 2014/30/UE
- Directive basse tension 2014/35/UE
- Directive RoHS II 2011/65/UE (sans participation d'un organisme désigné)
- Directive (CE) no. 1907/2006 (REACH) (sans participation d'un organisme désigné)

Normes appliquées:

Conformément à la liste des normes appliquées relatives aux cycles du produit.

Sono state applicate le seguenti direttive e regolamenti europei:

- Direttive per macchine 2006/42/EU
- Direttive per compatibilità elettromagnetica 2014/30/EU
- Direttive per basse tensioni 2014/35/EU
- RoHS II direttive 2011/65/EU (senza concorso di un citato collaboratore)
- Regolamento (CE) n. 1907/2006 (REACH) (senza concorso di un citato collaboratore)

Norme applicate:

Conformemente alla lista delle norme applicate, che sono parte degli atti del prodotto.

Tuttlingen, 2016-07-20



Klaus-Günter Eberle
Geschäftsführer, Manager,
Directeur, Gerente



Hettich

LAB TECHNOLOGY

Für dieses Gerät gültige Normen und Vorschriften

Das Gerät ist ein Produkt mit einem sehr hohen technischen Niveau. Es unterliegt umfangreichen Prüf- und Zertifizierungsverfahren gemäß folgenden Normen und Vorschriften in deren jeweils gültigen Fassung:

Elektrische und mechanische Sicherheit für Konstruktion und Endprüfung:

Normbaureihe: IEC 61010 (entspricht der Normenreihe DIN EN 61010)

- IEC 61010-1 "Sicherheitsbestimmungen für elektrische Mess-, Steuer-, Regel- und Laborgeräte - Teil 1: Allgemeine Anforderungen" (Verschmutzungsgrad 2, Überspannungskategorie II)
- IEC 61010-2-010 "Sicherheitsbestimmungen für elektrische Mess-, Steuer-, Regel- und Laborgeräte – Teil 2-010: Besondere Anforderungen an Laborgeräte für das Erhitzen von Stoffen" (nur für Zentrifugen mit Heizung gültig)
- IEC 61010-2-020 "Sicherheitsbestimmungen für elektrische Mess-, Steuer-, Regel- und Laborgeräte - Teil 2-020: Besondere Anforderungen an Laborzentrifugen"
- IEC 61010-2-101 "Sicherheitsbestimmungen für elektrische Mess-, Steuer-, Regel- und Laborgeräte - Teil 2-101: Besondere Anforderungen an In-vitro-Diagnostik (IVD) Medizingeräte"

Elektromagnetische Verträglichkeit:

- EN 61326-1 "Elektrische Mess-, Steuer-, Regel- und Laborgeräte - EMV-Anforderungen - Teil 1: Allgemeine Anforderungen"

Risikomanagement:

- DIN EN ISO 14971 "Anwendung des Risikomanagements auf Medizinprodukte"

Beschränkung gefährlicher Stoffe (RoHS II):

- EN 50581 „Technische Dokumentation zur Beurteilung von Elektro- und Elektronikgeräten hinsichtlich der Beschränkung gefährlicher Stoffe“

Für Konformitätsbewertungsverfahren geltende Europäische Richtlinien:

- Richtlinie 98/79/EC über In-vitro-Diagnosegeräte
EG-Konformitätsbewertungsverfahren gemäß Anhang III "EG-Konformitätserklärung" – Eigenerklärung des Herstellers
- Richtlinie 2011/65/EU zur Beschränkung der Verwendung bestimmter gefährlicher Stoffe in Elektro- und Elektronikgeräten. Das EG-Konformitätsbewertungsverfahren erfolgt hierzu in alleiniger Verantwortung des Herstellers, ohne Beteiligung einer benannten Stelle.

Außerhalb Europas geltende Richtlinien für Medizinprodukte:

- **USA:** QSR, 21CFR 820 "CFR Title 21 - Food and Drugs: TITLE 21- FOOD AND DRUGS, CHAPTER I - FOOD AND DRUG ADMINISTRATION DEPARTMENT OF HEALTH AND HUMAN SERVICES, SUBCHAPTER H - MEDICAL DEVICES, Part 820 QUALITY SYSTEM REGULATIONS"
- **Kanada:** CMDR, SOR/98-282 "Medical Devices Regulations"

Zertifiziertes Qualitätsmanagementsystem gemäß

- ISO 9001 "Qualitätsmanagementsysteme - Anforderungen"
- ISO 13485 "Qualitätsmanagementsysteme für Medizinprodukte - Anforderungen für regulatorische Zwecke"

Umweltmanagementsystem gemäß

- ISO 14001 "Umweltmanagementsysteme - Spezifikation mit Anleitung zur Anwendung"

Standards and regulations which apply to this device

The device is a high-end technical product. It is subject to extensive testing and certification procedures according to the following standards and regulations in their respectively valid version:

Electrical and mechanical safety for design and final testing:

Standard series: IEC 61010 (conform to standards of DIN EN 61010)

- IEC 61010-1 "Safety requirements for electrical equipment for measurement, control, and laboratory use - Part 1: General requirements" (Pollution Degree 2, Excess-voltage category II)
- IEC 61010-2-010 "Safety requirements for electrical equipment for measurement, control and laboratory use - Part 2-010: Particular requirements for laboratory equipment for the heating of materials" (applied to heated centrifuges only)
- IEC 61010-2-020 "Safety requirements for electrical equipment for measurement, control, and laboratory use - Part 2-020: Particular requirements for laboratory centrifuges"
- IEC 61010-2-101 "Safety requirements for electrical equipment for measurement, control and laboratory use - Part 2-101: Particular requirements for in vitro diagnostic (IVD) medical equipment"

Electromagnetic Compatibility:

- EN 61326-1 "Electrical equipment for measurement, control and laboratory use - EMC requirements - Part 1: General requirements"

Risk management:

- DIN EN ISO 14971 "Application of risk management to medical devices"

Restriction of Hazardous Substances (RoHS II):

- EN 50581 "Technical documentation for assessing electric and electronic devices with regard to the restriction of hazardous substances"

European directives applied for conformity assessment procedures:

- In vitro diagnostic device directive 98/79/EG
EC conformity assessment procedure according to annex III "EC DECLARATION OF CONFORMITY" – self-declaration by the manufacturer
- Directive 2011/65/EU for the restriction of use of certain hazardous substances in electric and electronic devices. Carrying out the EC conformity assessment process is the sole responsibility of the manufacturer, without the involvement of a notified body.

Applied medical device regulations outside Europe:

- **USA:** QSR, 21CFR 820 "CFR Title 21 - Food and Drugs: TITLE 21- FOOD AND DRUGS, CHAPTER I - FOOD AND DRUG ADMINISTRATION DEPARTMENT OF HEALTH AND HUMAN SERVICES, SUBCHAPTER H - MEDICAL DEVICES, Part 820 QUALITY SYSTEM REGULATIONS"
- **Canada:** CMDR, SOR/98-282 "Medical Devices Regulations"

Certified quality management system according to

- ISO 9001 "Quality management systems – Requirements"
- ISO13485 "Medical devices - Quality management systems - Requirements for regulatory purposes"

Environmental management system according to

- ISO 14001 "Environmental management systems - Requirements with guidance for use"

Normes et règles en vigueur pour cet appareil

Cet appareil est un produit avec un très haut niveau technique. Il est soumis à des vastes procédures de vérification et de certification, d'après les normes et prescriptions suivantes, dans leur version actuelle :

Sécurité électrique et mécanique pour la construction et l'inspection finale :

Série de normes : IEC 61010 (correspond à la série de norme DIN EN 61010)

- IEC 61010-1 "Règles de sécurité pour appareils électriques de mesurage, de régulation et de laboratoire - partie 1 : Prescriptions générales" (niveau de saleté 2, catégorie de surtension II)
- IEC 61010-2-010 "Règles de sécurité pour appareils électriques de mesurage, de régulation et de laboratoire – partie 2-010 : Prescriptions particulières pour appareils de laboratoire utilisés pour l'échauffement des matières" (seulement valable pour centrifugeuses avec chauffage)
- IEC 61010-2-020 "Règles de sécurité pour appareils électriques de mesurage, de régulation et de laboratoire – partie 2-020 : Prescriptions particulières pour centrifugeuses de laboratoire"
- IEC 61010-2-101 "Règles de sécurité pour appareils électriques de mesurage, de régulation et de laboratoire – partie 2-101 : Prescriptions particulières pour les appareils médicaux de diagnostic in vitro" (DIV)

Compatibilité électromagnétique :

- EN 61326-1 "Matériel électrique de mesure, de commande et de laboratoire – Exigences relatives à la CEM - partie 1 : Exigences générales"

Gestion des risques :

- DIN EN ISO 14971 "Application de la gestion des risques aux dispositifs médicaux"

Restrictions relatives aux substances dangereuses (RoHS II):

- Norme européenne 50581 „Documentation technique pour l'évaluation des produits électriques et électroniques par rapport à la restriction des substances dangereuses“

Directives européennes valables pour des procédures d'évaluation de la conformité :

- directive 98/79/EC relative aux dispositifs médicaux de diagnostic in vitro
procédure d'évaluation de la conformité CE d'après l'annexe III "Déclaration CE de conformité" – déclaration spécifique du fabricant
- Directives 2011/65/UE concernant les restrictions relatives à l'utilisation de certaines substances dangereuses dans les appareils électriques et électroniques. La procédure d'évaluation de la conformité CE est sous la seule responsabilité du fabricant, sans participation d'un organisme désigné.

Directives pour dispositifs médicaux, valables en dehors de l'Europe :

- **USA** : QSR, 21CFR 820 "CFR Title 21 - Food and Drugs : TITLE 21- FOOD AND DRUGS, CHAPTER I - FOOD AND DRUG ADMINISTRATION DEPARTMENT OF HEALTH AND HUMAN SERVICES, SUBCHAPTER H - MEDICAL DEVICES, Part 820 QUALITY SYSTEM REGULATIONS"
- **Canada**: CMDR, SOR/98-282 "Medical Devices Regulations"

Système de management de la qualité certifié d'après

- ISO 9001 "Systèmes de management de la qualité - Prescriptions"
- ISO13485 "Dispositifs médicaux - Systèmes de management de la qualité - Exigences à des fins réglementaires"

Système de management environnemental d'après

- ISO 14001 "Systèmes de management environnemental - Spécification avec description pour application"

Norme e direttive valide per questo apparecchio

L'apparecchio è un dispositivo di elevatissimo livello tecnico. È sottoposto a numerosi procedimenti di collaudo e certificazione, in conformità alle seguenti norme e direttive nella corrispondente versione di validità:

Sicurezza elettrica e meccanica per la costruzione ed il collaudo finale:

Serie di norma: IEC 61010 (corrisponde alla serie di norma DIN EN 61010)

- IEC 61010-1 "Norme di sicurezza per apparecchiature elettriche di misurazione, di comando, di regolazione e di laboratorio - parte 1: Requisiti generali" (grado di imbrattamento 2, Categoria di sovratensione II)
- IEC 61010-2 -010 "Norme di sicurezza per apparecchiature elettriche di misurazione, di comando, di regolazione e di laboratorio - parte 2-010: Requisiti particolari per le apparecchiature di laboratorio per il riscaldamento di materiali" (valido solo per centrifughe con riscaldamento)
- IEC 61010-2 -020 "Norme di sicurezza per apparecchiature elettriche di misurazione, di comando, di regolazione e di laboratorio - parte 2-020: Requisiti particolari per centrifughe di laboratorio"
- IEC 61010-2 -101 "Norme di sicurezza per apparecchiature elettriche di misurazione, di comando, di regolazione e di laboratorio - parte 2-101: Requisiti particolari per la diagnostica In-vitro (IVD) apparecchiature medicali"

Compatibilità elettromagnetica:

- EN 61326-1 "Apparecchiature elettriche di misurazione, di comando, di regolazione e di laboratorio - requisiti di compatibilità elettromagnetica - parte 1: Requisiti generali"

Gestione dei rischi:

- DIN EN ISO 14971 "Applicazione della gestione dei rischi ai dispositivi medici"

Restrizione per prodotti pericolosi (RoHS II):

- EN 50581 „Documentazione tecnica per la stesura di un protocollo di valutazione delle apparecchiature elettriche ed elettroniche per quanto riguarda la restrizione per prodotti pericolosi“

Direttive europee che sono di validità per il procedimento di valutazione della conformità:

- Direttive 98/79/CE per apparecchiature di diagnosi In-vitro
Procedimento di valutazione di conformità CE conforme all'appendice III "Dichiarazione di conformità CE" – Dichiarazione propria del costruttore
- Direttive 2011/65/EU per la restrizione di impiego di particolari prodotti pericolosi nelle apparecchiature elettriche ed elettroniche. Il procedimento di valutazione della conformità CE avviene al riguardo nella sola responsabilità del costruttore, senza concorso di un citato collaboratore.

Direttive valide al di fuori dell'ambito europeo per i prodotti medicali:

- **USA:** QSR, 21CFR 820 "CFR Title 21 - Food and Drugs: TITLE 21- FOOD AND DRUGS, CHAPTER I - FOOD AND DRUG ADMINISTRATION DEPARTMENT OF HEALTH AND HUMAN SERVICES, SUBCHAPTER H - MEDICAL DEVICES, Part 820 QUALITY SYSTEM REGULATIONS"
- **Kanada:** CMDR, SOR/98-282 "Medical Devices Regulations"

Certificato sistema di gestione della qualità, conforme a

- ISO 9001 "Requisiti per sistemi di gestione qualità"
- ISO13485 "Sistemi di gestione qualità per prodotti medicali - Requisiti per impieghi di regolazione"

Sistema di gestione ambientale, conforme a

- ISO 14001 "Sistemi di gestione ambientale - Specificazione con istruzioni per l'applicazione"

Andreas Hettich GmbH & Co. KG
Föhrenstraße 12, D-78532 Tuttlingen / Germany
Phone +49 (0)7461 / 705-0
Fax +49 (0)7461 / 705-1125
info@hettichlab.com, service@hettichlab.com
www.hettichlab.com



© 2005 by Andreas Hettich GmbH & Co. KG

All rights reserved. No part of this publication may be reproduced without the prior written permission of the copyright owner.

Änderungen vorbehalten! , Modifications reserved! , Sous réserve de modifications ! , Con riserva di modifiche!

AB1401DEENFRIT / Rev. 05 / 08.17

Inhaltsverzeichnis

1	Bestimmungsgemäße Verwendung.....	12
2	Restrisiken.....	12
3	Technische Daten.....	12
4	Sicherheitshinweise.....	15
5	Bedeutung der Symbole.....	17
6	Lieferumfang.....	17
7	Auspacken der Zentrifuge.....	17
8	Inbetriebnahme.....	18
9	Deckel öffnen und schließen.....	18
9.1	Deckel öffnen.....	18
9.2	Deckel schließen.....	18
10	Ein- und Ausbau des Rotors.....	19
10.1	Rotor mit Spannmutter.....	19
10.2	Rotor ohne Spannmutter.....	19
10.2.1	Ein- und Ausbau der Nabe.....	19
10.2.2	Einsetzen und Herausnehmen des Rotors.....	19
11	Beladen des Rotors.....	20
12	Adapter mit Positionierungszapfen in Gehänge einsetzen.....	21
13	Handhabung von Bio-Sicherheitssystemen.....	21
13.1	Deckel von Bio-Sicherheitssystemen schließen und öffnen.....	21
13.1.1	Deckel mit Schraubverschluss und Bohrung im Drehgriff.....	21
13.1.2	Deckel mit Schraubverschluss.....	22
13.1.3	Deckel mit Bügel und Spannverschluss.....	22
13.2	Lagerung von Bio-Sicherheitssystemen.....	22
14	Bedien- und Anzeigeelemente.....	23
14.1	Drehknopf.....	23
14.2	Tasten des Bedienfeldes.....	23
14.3	Einstellmöglichkeiten.....	23
15	Zentrifugations-Parameter eingeben.....	24
16	Programmierung.....	24
16.1	Programm -Eingabe / -Änderung.....	24
16.2	Programm-Abruf.....	24
17	Zentrifugation.....	25
17.1	Zentrifugation mit Zeitvorwahl.....	25
17.2	Dauerlauf.....	25
17.3	Kurzzeitzentrifugation.....	25
18	Not-Stop.....	25
19	Akustisches Signal.....	26
20	Betriebsstunden-Abfrage.....	26
21	Kühlung (nur bei Zentrifuge mit Kühlung).....	26
21.1	Standby-Kühlung.....	26
21.2	Vorkühlen des Rotors.....	26
22	Relative Zentrifugalbeschleunigung (RCF).....	27

23	Zentrifugation von Stoffen oder Stoffgemischen mit einer höheren Dichte als $1,2 \text{ kg/dm}^3$	27
24	Rotorerkennung.....	27
25	Notentriegelung	28
26	Pflege und Wartung.....	28
26.1	Zentrifuge (Gehäuse, Deckel und Schleuderraum)	29
26.1.1	Oberflächenreinigung und -pflege.....	29
26.1.2	Oberflächendesinfektion	29
26.1.3	Entfernen radioaktiver Verunreinigungen.....	29
26.2	Rotoren und Zubehör	30
26.2.1	Reinigung und Pflege.....	30
26.2.2	Desinfektion	30
26.2.3	Entfernen radioaktiver Verunreinigungen.....	31
26.2.4	Tragzapfen.....	31
26.2.5	Rotoren und Zubehör mit begrenzter Verwendungsdauer	31
26.3	Autoklavieren	31
26.4	ZentrifugiergefäÙe.....	31
27	Störungen.....	32
28	Rücksendung von Geräten.....	33
29	Entsorgung	33
30	Anhang / Appendix	106
30.1	Rotoren und Zubehör / Rotors and accessories.....	106

1 Bestimmungsgemäße Verwendung

Bei dem vorliegenden Gerät handelt es sich um ein Medizinprodukt (Laborzentrifuge) im Sinne der IVD-Richtlinie 98/79/EG.

Die Zentrifuge dient zum Trennen von Stoffen bzw. Stoffgemischen mit einer Dichte von max. 1,2 kg/dm³. Darunter fallen insbesondere Proben zur Vorbereitung für In-vitro diagnostische Zwecke in der Humanmedizin.

Die Zentrifuge ist nur für diesen Verwendungszweck bestimmt.

Eine andere oder darüber hinausgehende Benutzung gilt als nicht bestimmungsgemäß. Für hieraus entstehende Schäden haftet die Firma Andreas Hettich GmbH & Co. KG nicht.

Zur bestimmungsgemäßen Verwendung gehört auch das Beachten aller Hinweise aus der Bedienungsanleitung und die Einhaltung der Inspektions- und Wartungsarbeiten.

2 Restrisiken

Das Gerät ist nach dem Stand der Technik und den anerkannten sicherheitstechnischen Regeln gebaut. Bei unsachgemäßer Verwendung und Behandlung können Gefahren für Leib und Leben des Benutzers oder Dritter bzw. Beeinträchtigungen an dem Gerät oder an anderen Sachwerten entstehen. Das Gerät ist nur für die bestimmungsgemäße Verwendung, und nur in sicherheitstechnisch einwandfreiem Zustand zu benutzen.

Störungen, die die Sicherheit beeinträchtigen können, sind umgehend zu beseitigen.

3 Technische Daten

Hersteller	Andreas Hettich GmbH & Co. KG D-78532 Tuttlingen				
Modell	UNIVERSAL 320		UNIVERSAL 320 R		
Typ	1401	1401-01	1406	1406-01	
Netzspannung ($\pm 10\%$)	200-240 V 1~	100-127 V 1~	200-240 V 1~	240 V 1~	115-127 V 1~
Netzfrequenz	50 – 60 Hz	50 – 60 Hz	50 Hz	60 Hz	60 Hz
Anschlusswert	400 VA	400 VA	800 VA		950 VA
Stromaufnahme	2.0 A	4.0 A	4.0 A		8.0 A
Kältemittel	----		R 404A		
Kapazität max.	4 x 200 ml				
zulässige Dichte	1.2 kg/dm ³				
Drehzahl (RPM)	16000				
Beschleunigung (RCF)	24900				
Kinetische Energie	9500 Nm				
Prüfpflicht (DGUV Regel 100 - 500)	nein				
Umgebungsbedingungen (EN / IEC 61010-1)	<p>nur in Innenräumen bis zu 2000 m über Normal-Null</p> <p>2°C bis 35°C 5°C bis 35°C</p> <p>maximale relative Luftfeuchte 80% für Temperaturen bis 31°C, linear abnehmend bis 50% relativer Luftfeuchte bei 40°C.</p>				
– Aufstellungsort					
– Höhe					
– Umgebungstemperatur					
– Luftfeuchtigkeit					
– Überspannungskategorie (IEC 60364-4-443)	II				
– Verschmutzungsgrad	2				
Geräteschutzklasse	I				
nicht für den Einsatz in explosionsgefährdeter Umgebung geeignet.					
EMV					
– Störaussendung, Störfestigkeit	EN / IEC 61326-1, Klasse B	FCC Class B	EN / IEC 61326-1, Klasse B	FCC Class B	
Geräuschpegel (rotorabhängig)	≤ 68 dB(A)		≤ 64 dB(A)		
Abmessungen					
– Breite	401 mm		407 mm		
– Tiefe	529 mm		698 mm		
– Höhe	346 mm		346 mm		
Gewicht	ca. 31 kg		ca. 52 kg		

Hersteller	Andreas Hettich GmbH & Co. KG D-78532 Tuttlingen			
Modell	UNIVERSAL 320 R			
Typ	1406-50	1406-51	1406-70	1406-71
Netzspannung ($\pm 10\%$)	200-240 V 1~	100-127 V 1~	200-240 V 1~	100-127 V 1~
Netzfrequenz	50 – 60 Hz	50 – 60 Hz	50 – 60 Hz	50 – 60 Hz
Anschlusswert	400 VA	400 VA	400 VA	400 VA
Stromaufnahme	2.0 A	4.0 A	2.0 A	4.0 A
Kapazität max.	4 x 200 ml			
zulässige Dichte	1.2 kg/dm ³			
Drehzahl (RPM)	16000			
Beschleunigung (RCF)	24900			
Kinetische Energie	9500 Nm			
Prüfpflicht (DGUV Regel 100 - 500)	nein			
Umgebungsbedingungen (EN / IEC 61010-1)	<p>nur in Innenräumen bis zu 2000 m über Normal-Null 2°C bis 35°C maximale relative Luftfeuchte 80% für Temperaturen bis 31°C, linear abnehmend bis 50% relativer Luftfeuchte bei 40°C.</p>			
– Aufstellungsort				
– Höhe				
– Umgebungstemperatur				
– Luftfeuchtigkeit				
– Überspannungskategorie (IEC 60364-4-443)	II			
– Verschmutzungsgrad	2			
Geräteschutzklasse	I			
nicht für den Einsatz in explosionsgefährdeter Umgebung geeignet.				
EMV	EN / IEC 61326-1, Klasse B		FCC Class B	
– Störaussendung, Störfestigkeit	EN / IEC 61326-1, Klasse B	FCC Class B	EN / IEC 61326-1, Klasse B	FCC Class B
Geräuschpegel (rotorabhängig)	≤ 64 dB(A)			
Abmessungen				
– Breite	401 mm		401 mm	
– Tiefe	549 mm		550 mm	
– Höhe	346 mm		365 mm	
Gewicht	ca. 35 kg			

Hersteller	Andreas Hettich GmbH & Co. KG D-78532 Tuttlingen		
Modell	UNIVERSAL 320 R		
Typ	1406-20	1406-21	
Netzspannung ($\pm 10\%$)	200-240 V 1~	240 V 1~	115-127 V 1~
Netzfrequenz	50 Hz	60 Hz	60 Hz
Anschlusswert	800 VA		950VA
Stromaufnahme	4.0 A		8.0 A
Kältemittel	R 404A		
Kapazität max.	4 x 200 ml		
zulässige Dichte	1.2 kg/dm ³		
Drehzahl (RPM)	16000		
Beschleunigung (RCF)	24900		
Kinetische Energie	9500 Nm		
Prüfpflicht (DGUV Regel 100 - 500)	nein		
Umgebungsbedingungen (EN / IEC 61010-1)	<p>nur in Innenräumen bis zu 2000 m über Normal-Null 5°C bis 35°C maximale relative Luftfeuchte 80% für Temperaturen bis 31°C, linear abnehmend bis 50% relativer Luftfeuchte bei 40°C.</p>		
– Aufstellungsort			
– Höhe			
– Umgebungstemperatur			
– Luftfeuchtigkeit			
– Überspannungskategorie (IEC 60364-4-443)	II		
– Verschmutzungsgrad	2		
Geräteschutzklasse	I		
nicht für den Einsatz in explosionsgefährdeter Umgebung geeignet.			
EMV			
– Störaussendung, Störfestigkeit	EN / IEC 61326-1, Klasse B	FCC Class B	
Geräuschpegel (rotorabhängig)	≤ 64 dB(A)		
Abmessungen			
– Breite	407 mm		
– Tiefe	725 mm		
– Höhe	365 mm		
Gewicht	ca. 52 kg		

4 Sicherheitshinweise



Werden nicht alle Hinweise in dieser Bedienungsanleitung befolgt, kann beim Hersteller kein Gewährleistungsanspruch geltend gemacht werden.



- Die Zentrifuge ist so aufzustellen, dass sie standsicher betrieben werden kann.
- Vor Benutzung der Zentrifuge unbedingt den Rotor auf festen Sitz prüfen.
- Während eines Zentrifugationslaufes dürfen sich gemäß EN / IEC 61010-2-020, in einem Sicherheitsbereich von 300 mm um die Zentrifuge herum, keine Personen, Gefahrstoffe und Gegenstände befinden.
- Rotoren, Gehänge und Zubehörteile, die starke Korrosionsspuren oder mechanische Schäden aufweisen, oder deren Verwendungsdauer abgelaufen ist, dürfen nicht mehr verwendet werden.
- Die Zentrifuge darf nicht mehr in Betrieb genommen werden, wenn der Schleuderraum sicherheitsrelevante Schäden aufweist.
- Bei Ausschwingrotoren müssen die Tragzapfen regelmäßig gefettet werden (Hettich-Schmierfett Nr. 4051), um ein gleichmäßiges Ausschwingen der Gehänge zu gewährleisten.
- Bei Zentrifugen ohne Temperaturregelung kann es bei erhöhter Raumtemperatur und/oder bei häufigem Gebrauch des Gerätes zur Erwärmung des Schleuderraums kommen. Eine temperaturbedingte Veränderung des Probenmaterials kann deshalb nicht ausgeschlossen werden.

- Vor Inbetriebnahme der Zentrifuge ist die Bedienungsanleitung zu lesen und zu beachten. Nur Personen, die die Bedienungsanleitung gelesen und verstanden haben, dürfen das Gerät bedienen.
- Neben der Bedienungsanleitung und den verbindlichen Regelungen der Unfallverhütung sind auch die anerkannten fachtechnischen Regeln für sicherheits- und fachgerechtes Arbeiten zu beachten. Die Bedienungsanleitung ist um Anweisungen aufgrund bestehender nationaler Vorschriften des Verwenderlandes zur Unfallverhütung und zum Umweltschutz zu ergänzen.
- Die Zentrifuge ist nach dem Stand der Technik gebaut und betriebssicher. Es können aber von ihr Gefahren für den Benutzer oder Dritte ausgehen, wenn sie nicht von geschultem Personal oder unsachgemäß oder zu nicht bestimmungsgemäßem Gebrauch eingesetzt wird.
- Die Zentrifuge darf während des Betriebs nicht bewegt oder angestoßen werden.
- Im Störfall bzw. bei der Notentriegelung nie in den sich drehenden Rotor greifen.
- Um Schäden durch Kondensat zu vermeiden, muss bei Wechsel von einem kalten in einen warmen Raum, die Zentrifuge entweder mindestens 3 Stunden im warmen Raum aufwärmen bevor sie an das Netz angeschlossen werden darf oder 30 Minuten im kalten Raum warmlaufen.
- Es dürfen nur die vom Hersteller für dieses Gerät zugelassenen Rotoren und das zugelassene Zubehör verwendet werden (siehe Kapitel "Anhang/Appendix, Rotoren und Zubehör/Rotors and accessories"). Bevor Zentrifugiergefäße verwendet werden, die nicht in Kapitel "Anhang/Appendix, Rotoren und Zubehör/Rotors and accessories" aufgeführt sind, hat sich der Benutzer beim Hersteller zu vergewissern, ob diese verwendet werden dürfen.
- Der Rotor der Zentrifuge darf nur entsprechend dem Kapitel "Beladen des Rotors" beladen werden.
- Bei der Zentrifugation mit maximaler Drehzahl darf die Dichte der Stoffe oder Stoffgemische $1,2 \text{ kg/dm}^3$ nicht überschreiten.
- Zentrifugationen mit unzulässiger Unwucht sind nicht erlaubt.
- Die Zentrifuge darf nicht in explosionsgefährdeter Umgebung betrieben werden.
- Eine Zentrifugation mit:
 - brennbaren oder explosiven Materialien
 - Materialien, die chemisch mit hoher Energie miteinander reagieren ist verboten.

- Bei der Zentrifugation von gefährlichen Stoffen bzw. Stoffgemischen, die toxisch, radioaktiv oder mit pathogenen Mikroorganismen verseucht sind, sind durch den Benutzer geeignete Maßnahmen zu treffen. Es müssen grundsätzlich Zentrifugiergefäße mit speziellen Schraubverschlüssen für gefährliche Substanzen verwendet werden. Bei Materialien der Risikogruppe 3 und 4 ist zusätzlich zu den verschließbaren Zentrifugiergefäßen ein Bio-Sicherheitssystem zu verwenden (siehe Handbuch "Laboratory Bio-safety Manual" der Weltgesundheitsorganisation).
Bei einem Bio-Sicherheitssystem verhindert eine Bioabdichtung (Dichtungsring) das Austreten von Tröpfchen und Aerosolen.
Wird das Gehänge eines Bio-Sicherheitssystems ohne den Deckel verwendet, muss der Dichtungsring vom Gehänge entfernt werden, um eine Beschädigung des Dichtungsringes während des Zentrifugationslaufes zu vermeiden.
Beschädigte Bio-Sicherheitssysteme sind nicht mehr mikrobiologisch dicht.
Ohne Verwendung eines Bio-Sicherheitssystems ist eine Zentrifuge im Sinne der Norm EN / IEC 61010-2-020 nicht mikrobiologisch dicht.
Beim Schließen eines Bio-Sicherheitssystems sind die Anweisungen in Kapitel "Handhabung von Bio-Sicherheitssystemen" zu befolgen.
Lieferbare Bio-Sicherheitssysteme siehe Kapitel "Anhang/Appendix, Rotoren und Zubehör/Rotors and accessories". Im Zweifelsfall sind entsprechende Informationen beim Hersteller einzuholen.
- Der Betrieb der Zentrifuge mit stark korrodierenden Stoffen, welche die mechanische Festigkeit von Rotoren, Gehängen und Zubehörteilen beeinträchtigen können, ist nicht erlaubt.
- Reparaturen dürfen nur von einer vom Hersteller autorisierten Person ausgeführt werden.
- Es dürfen nur Originalersatzteile und zugelassenes Originalzubehör der Firma Andreas Hettich GmbH & Co. KG verwendet werden.
- Es gelten die folgenden Sicherheitsbestimmungen:
EN / IEC 61010-1 und EN / IEC 61010-2-020 sowie deren nationalen Abweichungen.
- Die Sicherheit und Zuverlässigkeit der Zentrifuge ist nur dann gewährleistet, wenn:
 - die Zentrifuge nach der Bedienungsanleitung betrieben wird.
 - die elektrische Installation, am Aufstellungsort der Zentrifuge, den Anforderungen von EN / IEC Festlegungen entspricht.
 - die in den jeweiligen Ländern vorgeschriebenen Prüfungen für die Sicherheit des Gerätes, z. B. in Deutschland nach DGUV Vorschrift 3, durch einen Sachkundigen durchgeführt werden..

5 Bedeutung der Symbole



Symbol am Gerät:

Achtung, allgemeine Gefahrenstelle.

Vor Benutzung des Gerätes unbedingt die Bedienungsanleitung lesen und die sicherheitsrelevanten Hinweise beachten!



Symbol in diesem Dokument:

Achtung, allgemeine Gefahrenstelle.

Dieses Symbol kennzeichnet sicherheitsrelevante Hinweise und deutet auf mögliche gefährliche Situationen hin.

Das Nichtbeachten dieser Hinweise kann zu Sach- und Personenschäden führen.



Symbol am Gerät und in diesem Dokument:

Warnung vor Biogefährdung.



Symbol in diesem Dokument:

Dieses Symbol deutet auf wichtige Sachverhalte hin.



Symbol am Gerät und in diesem Dokument:

Symbol für die getrennte Sammlung von Elektro- und Elektronikgeräten, gemäß der Richtlinie 2002/96/EG (WEEE). Das Gerät gehört zur Gruppe 8 (Medizinische Geräte).

Verwendung in den Ländern der Europäischen Union sowie in Norwegen und der Schweiz.

6 Lieferumfang

- 1 Anschlusskabel
- 1 Sechskant-Stiftschlüssel
- 1 Schmierfett für Tragzapfen
- 1 Bedienungsanleitung
- 1 Hinweisblatt Transportsicherung

Rotor(en) und das entsprechende Zubehör werden je nach Bestellung mitgeliefert.

7 Auspacken der Zentrifuge

- Den Karton nach oben abheben und die Polsterung entfernen.

- | | |
|---|---|
|  | Nicht an der Frontblende anheben.
Das Gewicht der Zentrifuge beachten, siehe Kapitel "Technische Daten". |
|---|---|

Die Zentrifuge, mit der angemessenen Anzahl von Helfern, an beiden Seiten anheben und auf den Labortisch stellen.

8 Inbetriebnahme

- Die Transportsicherung am Gehäuseboden entfernen, siehe Hinweisblatt "Transportsicherung".
- **Die Zentrifuge an einem geeigneten Platz standsicher aufstellen und nivellieren. Bei der Aufstellung ist der geforderte Sicherheitsbereich gemäß EN / IEC 61010-2-020, von 300 mm um die Zentrifuge herum, einzuhalten.**



Während eines Zentrifugationslaufes dürfen sich gemäß EN / IEC 61010-2-020, in einem Sicherheitsbereich von 300 mm um die Zentrifuge herum, keine Personen, Gefahrstoffe und Gegenstände befinden.

- Lüftungsöffnungen dürfen nicht zugestellt werden.
Es muss ein Abstand von 300 mm zu den Lüftungsschlitzen und Lüftungsöffnungen der Zentrifuge eingehalten werden.
- Bei der Zentrifuge, Best.-Nr. 1406-20, 1406-21, die Stickstoffversorgung gemäß dem beigefügten Hinweisblatt AH1406-20XX anschließen.
Bei der Zentrifuge, Best.-Nr. 1406-50, 1406-51, den Kälte-Umwälzthermostat gemäß dem beigefügten Hinweisblatt AH1406-50XX anschließen
Bei der Zentrifuge, Best.-Nr. 1406-70, 1406-71, den Kälte-Umwälzthermostat und die Stickstoffversorgung gemäß dem beigefügten Hinweisblatt AH1406-70XX anschließen.



Das Anschließen der Zentrifuge muss unbedingt gemäß dem beigefügten Hinweisblatt erfolgen.
Das beigefügte Hinweisblatt unbedingt beachten.

- Prüfen, ob die Netzspannung mit der Angabe auf dem Typenschild übereinstimmt.
- Die Zentrifuge mit dem Netzkabel an eine genormte Netzsteckdose anschließen. Anschlusswert siehe Kapitel "Technische Daten".
- Den Netzschalter einschalten. Schalterstellung "I".
Der Maschinentyp und die Programmversion werden angezeigt, die LED's leuchten. Nach 8 Sekunden wird **OPEN** / **OEFFNEN** angezeigt und die linke LED in der Taste **STOP/OPEN** blinkt.
- Den Deckel öffnen.
Die zuletzt benutzten Zentrifugierdaten werden angezeigt.

9 Deckel öffnen und schließen

9.1 Deckel öffnen



Der Deckel lässt sich nur öffnen, wenn die Zentrifuge eingeschaltet ist und der Rotor stillsteht.
Sollte dies nicht möglich sein, siehe Kapitel "Notentriegelung".

- Die Taste **OPEN/STOP** drücken. Der Deckel entriegelt motorisch und die linke LED in der Taste **OPEN/STOP** erlischt.

9.2 Deckel schließen



Mit den Fingern nicht zwischen Deckel und Gehäuse greifen.
Den Deckel nicht zuschlagen.

Wenn die linke LED in der Taste **OPEN/STOP** blinkt, die Taste **OPEN/STOP** drücken, dass die motorische Deckelverriegelung die Grundstellung (geöffnet) einnimmt.

- Den Deckel auflegen und die Deckelvorderkante leicht niederdrücken. Die Verriegelung erfolgt motorisch. Die linke LED in der Taste **OPEN/STOP** leuchtet auf.

10 Ein- und Ausbau des Rotors

10.1 Rotor mit Spannmutter

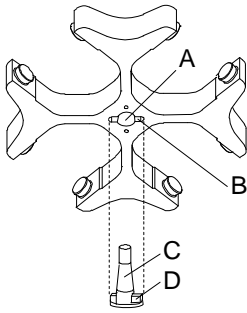

Einbau des Rotors:



Schmutzpartikel zwischen der Motorwelle und dem Rotor verhindern einen einwandfreien Sitz des Rotors und verursachen einen unruhigen Lauf.

- Die Motorwelle (C) und die Bohrung des Rotors (A) reinigen und anschließend die Motorwelle leicht einfetten.
- Den Rotor vertikal auf die Motorwelle aufsetzen. Der Mitnehmer der Motorwelle (D) muss sich in der Nut des Rotors (B) befinden. Auf dem Rotor ist die Ausrichtung der Nut gekennzeichnet.
- Die Spannmutter des Rotors mit dem mitgelieferten Schlüssel durch Drehen im Uhrzeigersinn anziehen.
- Den Rotor auf festen Sitz prüfen.

Ausbau des Rotors:

- Die Spannmutter durch Drehen entgegen dem Uhrzeigersinn lösen und bis zum Abhebe-Druckpunkt drehen. Nach Überwindung des Abhebe-Druckpunkts löst sich der Rotor vom Konus der Motorwelle.
- Die Spannmutter drehen, bis sich der Rotor von der Motorwelle abheben lässt.

10.2 Rotor ohne Spannmutter

10.2.1 Ein- und Ausbau der Nabe

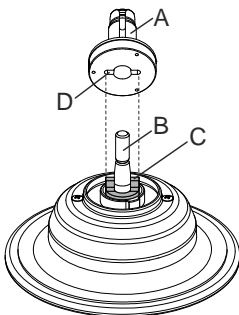

Einbau der Nabe:

- Die Nabe (A) vertikal auf die Motorwelle (B) aufsetzen. Der Mitnehmer (C) an der Motorwelle muss sich in der Nut (D) der Nabe befinden.
- Die Spannmutter der Nabe mit dem mitgelieferten Sechskant-Stiftschlüssel durch Drehen im Uhrzeigersinn anziehen.
- Die Nabe auf festen Sitz prüfen.

Ausbau der Nabe:

- Den Rotor herausnehmen.
- Die Spannmutter der Nabe durch Drehen entgegen dem Uhrzeigersinn lösen und bis zum Abhebe-Druckpunkt drehen. Nach Überwindung des Abhebe-Druckpunkts löst sich die Nabe vom Konus der Motorwelle.
- Die Spannmutter drehen, bis sich die Nabe von der Motorwelle abheben lässt.

10.2.2 Einsetzen und Herausnehmen des Rotors

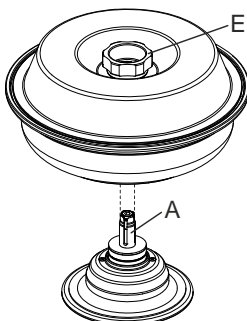

Einsetzen des Rotors:



Schmutzpartikel zwischen der Nabe und dem Rotor verhindern einen einwandfreien Sitz des Rotors und verursachen einen unruhigen Lauf. Bei Bedarf vor dem Einsetzen des Rotors die Nabe (A) auf der Motorwelle und die Nabe des Rotors reinigen.

- Den Rotor am Drehgriff (E) des Deckels anheben, waagrecht auf die Nabe (A) aufsetzen und bis zum Anschlag nach unten drücken.

Herausnehmen des Rotors:

- Den Rotor am Drehgriff (E) des Deckels festhalten und von der Nabe (A) abheben.

11 Beladen des Rotors



Standard-ZentrifugiergefäÙe aus Glas sind belastbar bis RZB 4000 (DIN 58970 Teil 2).

- Den Rotor auf festen Sitz prüfen.
- Bei Ausschwingrotoren müssen alle Plätze des Rotors mit **gleichen** Gehängen besetzt sein. Bestimmte Gehänge sind mit der Nummer des Rotorplatzes gekennzeichnet. Diese Gehänge dürfen nur in den entsprechenden Platz des Rotors eingesetzt werden. Gehänge die mit einer Set-Nummer gekennzeichnet sind, z. B. S001/4, dürfen nur im Set verwendet werden.
- Die Rotoren und Gehänge dürfen nur symmetrisch beladen werden. Die ZentrifugiergefäÙe müssen gleichmäÙig auf alle Plätze des Rotors verteilt werden. Zugelassene Kombinationen siehe Kapitel "Anhang/Appendix, Rotoren und Zubehör/Rotors and accessories". Bei Winkelrotoren müssen alle möglichen Plätze des Rotors beladen werden, siehe Kapitel "Anhang/Appendix, Rotoren und Zubehör/Rotors and accessories".

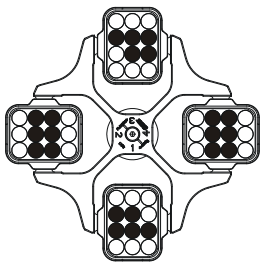

Rotor ist gleichmäÙig beladen

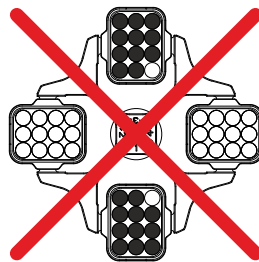

Nicht zulässig!

Rotor ist ungleichmäÙig beladen

- Auf bestimmten Gehängen ist das Gewicht der maximalen Beladung oder das Gewicht der maximalen Beladung und das maximale Gewicht des komplett bestückten Gehänges angegeben. Diese Gewichte dürfen nicht überschritten werden. Im Ausnahmefall siehe Kapitel "Zentrifugation von Stoffen oder Stoffgemischen mit einer höheren Dichte als $1,2 \text{ kg/dm}^3$ ". Die Gewichtsangabe der maximalen Beladung umfasst das Gesamtgewicht von Adapter, ZentrifugiergefäÙ und Inhalt.
- Bei Behältern mit Gummieinlagen muss sich unter den ZentrifugiergefäÙen immer die gleiche Anzahl von Gummieinlagen befinden.
- Die ZentrifugiergefäÙe dürfen nur außerhalb der Zentrifuge befüllt werden.
- Die vom Hersteller angegebene maximale Füllmenge der ZentrifugiergefäÙe darf nicht überschritten werden.

Bei Winkelrotoren dürfen die ZentrifugiergefäÙe nur soweit befüllt werden, dass während des Zentrifugationslaufes keine Flüssigkeit aus den GefäÙen herausgeschleudert werden kann.

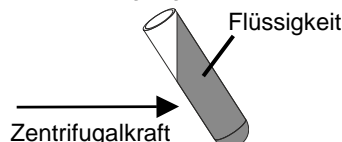

- Beim Beladen der Winkelrotoren darf keine Flüssigkeit in die Winkelrotoren und in den Schleuderraum gelangen.
- Beim Beladen der Gehänge der Ausschwingrotoren und beim Ausschwingen der Gehänge während des Zentrifugationslaufes darf keine Flüssigkeit in die Gehänge und in den Schleuderraum gelangen.
- Um die Gewichtsunterschiede innerhalb der ZentrifugiergefäÙe möglichst gering zu halten, ist auf eine gleichmäÙige Füllhöhe in den GefäÙen zu achten.

12 Adapter mit Positionierungszapfen in Gehänge einsetzen

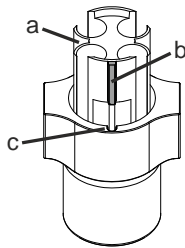

- Den Adapter (a) so in das Gehänge einsetzen, dass sich der Positionierungszapfen (b) in der Nut (c) des Gehänges befindet.



Wird der Adapter (a) nicht korrekt eingesetzt, können die Zentrifugiergefäße während des Zentrifugationslaufes beschädigt werden.

13 Handhabung von Bio-Sicherheitssystemen



Bio-Sicherheitssysteme dürfen nur im trockenen Zustand verwendet werden.

Vor jedem Gebrauch des Bio-Sicherheitssystems müssen alle Teile des Bio-Sicherheitssystems visuell auf Beschädigung überprüft werden. Außerdem muss die korrekte Einbaulage des Dichtungsringes bzw. der Dichtungsringe des Bio-Sicherheitssystems überprüft werden.

Die beschädigten Teile des Bio-Sicherheitssystems müssen sofort ausgetauscht werden.

Beschädigte Bio-Sicherheitssysteme sind nicht mehr mikrobiologisch dicht.

Um Dichtigkeit zu gewährleisten, muss der Deckel eines Bio-Sicherheitssystems korrekt verschlossen werden.

Lieferbare Bio-Sicherheitssysteme siehe Kapitel "Anhang/Appendix, Rotoren und Zubehör/Rotors and accessories". Im Zweifelsfall sind entsprechende Informationen beim Hersteller einzuholen.

13.1 Deckel von Bio-Sicherheitssystemen schließen und öffnen

13.1.1 Deckel mit Schraubverschluss und Bohrung im Drehgriff

Deckel schließen:

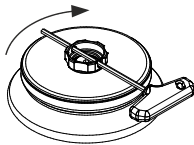

- Den Deckel mittig auf den Rotor aufsetzen.
- Den mitgelieferten Schlüssel durch die Bohrung im Drehgriff stecken und durch Drehen im Uhrzeigersinn den Deckel fest verschließen.

Deckel öffnen:

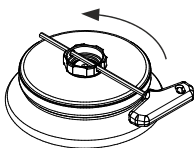

- Den mitgelieferten Schlüssel durch die Bohrung im Drehgriff stecken und solange entgegen dem Uhrzeigersinn drehen, bis sich der Deckel vom Rotor abnehmen lässt.

13.1.2 Deckel mit Schraubverschluss

Deckel schließen:

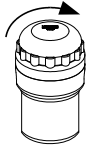

- Den Deckel auf das Gehäuse aufsetzen.
- Den Deckel von Hand, durch Drehen im Uhrzeigersinn, fest verschließen.

Deckel öffnen:

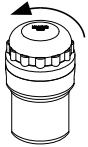

- Den Deckel von Hand solange entgegen dem Uhrzeigersinn drehen, bis sich der Deckel vom Gehäuse abnehmen lässt.

13.1.3 Deckel mit Bügel und Spannverschluss

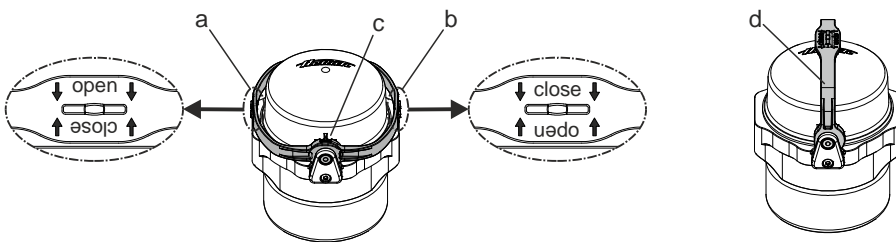

Deckel schließen:

- Den Bügel in Position "↓ open ↓" (a) schwenken. Die Pfeile der Beschriftung "↓ open ↓" müssen nach unten zeigen, so dass der Text "open" lesbar ist.
- Den Deckel so auf das Gehäuse aufsetzen, dass sich die beiden Zapfen des Deckels in den beiden Öffnungen des Bügels (c) befinden.
- Den Bügel auf die entgegengesetzte Seite des Gehänges, in Position "↓ close ↓" (b) schwenken. Die Pfeile der Beschriftung "↓ close ↓" müssen nach unten zeigen, so dass der Text "close" lesbar ist.



Der Bügel muss auf dem Gehäuse aufliegen, damit die Gehänge während des Zentrifugationslaufes ausschlagen können.

- Wird der Bügel in Position (d) geschwenkt, kann das Bio-Sicherheitssystem am Bügel getragen werden.



Die Dichtigkeit des Bio-Sicherheitssystems ist auch in der Trageposition gewährleistet.

Während des Transportierens das Bio-Sicherheitssystems nicht hin und her schaukeln, da sonst die Dichtigkeit nicht mehr gewährleistet ist.

- Zur einfacheren Handhabung beim Einsetzen und beim Herausnehmen des Gehänges den Bügel in Position (d) schwenken und das Gehäuse am Bügel festhalten.

Deckel öffnen:

- Den Bügel in Position "↓ open ↓" (a) schwenken. Die Pfeile der Beschriftung "↓ open ↓" müssen nach unten zeigen, so dass der Text "open" lesbar ist.
- Den Deckel vom Gehäuse abnehmen.

13.2 Lagerung von Bio-Sicherheitssystemen

- Um eine Beschädigung der Dichtringe während der Lagerung zu vermeiden, dürfen Bio-Sicherheitssysteme nur mit geöffnetem Deckel gelagert werden.

14 Bedien- und Anzeigeelemente

Siehe Abbildung auf Seite 2.

Fig. 2, Fig. 3: Anzeige- und Bedienfeld

14.1 Drehknopf



Zum Einstellen der einzelnen Parameter.
Drehen entgegen dem Uhrzeigersinn erniedrigt den Wert. Drehen im Uhrzeigersinn erhöht den Wert.

14.2 Tasten des Bedienfeldes



- Wähltaste zum Anwählen der einzelnen Parameter.
Durch jeden weiteren Tastendruck wird der nachfolgende Parameter angewählt.



- Zentrifugationslauf starten. Die LED in der Taste leuchtet während des Zentrifugationslaufes, solange der Rotor dreht.
- Kurzzeitzentrifugation.
Der Zentrifugationslauf erfolgt, solange die Taste gedrückt gehalten wird. Die LED in der Taste leuchtet während des Zentrifugationslaufes, solange der Rotor dreht.
- Eingaben und Änderungen speichern.



- Zentrifugationslauf beenden.
Der Rotor läuft mit vorgewählter Bremsstufe aus. Die rechte LED in der Taste leuchtet bis der Rotor stillsteht. Nach Stillstand des Rotors blinkt die linke LED in der Taste. Zweimaliges Drücken der Taste löst den NOT-STOP aus.
- Den Deckel entriegeln.
Die linke LED in der Taste erlischt.
- Verlassen der Parametereingabe.



- Umschalten zwischen RPM- und RCF-Anzeige.
RCF-Werte werden in > < angezeigt.



- Vorkühlung starten.
Die Vorkühl-Drehzahl ist einstellbar. Sie ist voreingestellt auf 2800 RPM.

14.3 Einstellmöglichkeiten

PROG RCL Programmplatz des abzurufenden Programms.

t/min Laufzeit. Einstellbar von 1 - 99 min, in 1 min -Schritten.

t/sec Laufzeit. Einstellbar von 1 - 59 s, in 1 Sekunden-Schritten.

Dauerlauf "∞". Parameter **t/min** und **t/sec** auf Null stellen.

RPM Drehzahl. Einstellbar ist ein Zahlenwert von 500 RPM bis zur maximalen Drehzahl des Rotors. Maximale Drehzahl des Rotors siehe Kapitel "Anhang/Appendix, Rotoren und Zubehör/Rotors and accessories". Einstellbar in 10er Schritten.

RAD/mm Zentrifugierradius. Eingabe in mm. Zentrifugierradius siehe Kapitel "Anhang/Appendix, Rotoren und Zubehör/Rotors and accessories". Die Eingabe des Radius ist nur möglich, wenn die RCF-Anzeige (> RCF <) angewählt ist.

RCF Relative Zentrifugalbeschleunigung. Einstellbar ist ein Zahlenwert, der eine Drehzahl zwischen 500 RPM und der maximalen Drehzahl des Rotors ergibt. Einstellbar bis 100 in 1er Schritten und ab 100 in 10er Schritten. Der RCF-Wert wird automatisch auf den Drehzahlschritt auf- bzw. abgerundet. Die Eingabe der RCF ist nur möglich, wenn die RCF-Anzeige (> RCF <) angewählt ist.



Anlaufstufen 1 - 9. Stufe 9 = kürzeste Anlaufzeit, Stufe 1 = längste Anlaufzeit.



Bremsstufen 0 - 9. Stufe 9 = kürzeste Auslaufzeit, Stufe 1 = lange Auslaufzeit, Stufe 0 = längste Auslaufzeit (ungebremster Auslauf).

- T/°C Temperatur-Sollwert (nur bei Zentrifuge mit Kühlung). Einstellbar von -20°C bis +40°C, in 1°C-Schritten. Die tiefste erreichbare Temperatur ist rotorabhängig (siehe Kapitel "Anhang/Appendix, Rotoren und Zubehör/Rotors and accessories").
- PROG STO Programmplatz auf dem das Programm gespeichert wird. Es können 9 Programme gespeichert werden (Programmplätze 1 - 2 - 3 - ... 9). Der Programmplatz # dient als Zwischenspeicher für geänderte Einstellungen.

15 Zentrifugations-Parameter eingeben

 Wird nach der Auswahl oder während der Eingabe von Parametern 8 Sekunden lang keine Taste gedrückt, werden in der Anzeige wieder die vorherigen Werte angezeigt. Die Eingabe der Parameter muss dann erneut durchgeführt werden.

- Mit der Taste **[RCF]** die RPM- oder RCF-Anzeige auswählen. RCF-Werte werden in **> <** angezeigt.
- Mit der Taste **[SELECT]** die gewünschten Parameter auswählen und mit dem Drehknopf **○** einstellen. Um den Dauerlauf einzustellen müssen die Parameter **t/min** und **t/sec** mit dem Drehknopf **○** auf Null gestellt werden. Der Dauerlauf wird in der Anzeige durch das Symbol "∞" angezeigt.
- Nach der Eingabe aller Parameter die Taste **[START/IMPULS]** drücken, um die Einstellungen auf Programmplatz # zu speichern. Als Bestätigung wird kurzzeitig ***** ok ***** angezeigt.

 Die Daten auf Programmplatz # werden bei jeder Eingabe von Parametern und Drücken der Taste **[START/IMPULS]** überschrieben.

16 Programmierung

16.1 Programm -Eingabe / -Änderung

 Wird nach der Auswahl oder während der Eingabe von Parametern 8 Sekunden lang keine Taste gedrückt, werden in der Anzeige wieder die vorherigen Werte angezeigt. Die Eingabe der Parameter muss dann erneut durchgeführt werden.

- Mit der Taste **[RCF]** die RPM- oder RCF-Anzeige auswählen. RCF-Werte werden in **> <** angezeigt.
- Mit der Taste **[SELECT]** die gewünschten Parameter auswählen und mit dem Drehknopf **○** einstellen. Um den Dauerlauf einzustellen müssen die Parameter **t/min** und **t/sec** mit dem Drehknopf **○** auf Null gestellt werden. Der Dauerlauf wird in der Anzeige durch das Symbol "∞" angezeigt.
- Mit der Taste **[SELECT]** den Parameter **PROG STO** auswählen und mit dem Drehknopf **○** den gewünschten Programmplatz einstellen.
- Die Taste **[START/IMPULS]** drücken, um die Einstellungen auf dem gewünschten Programmplatz zu speichern. Als Bestätigung wird kurzzeitig ***** ok ***** angezeigt. Wird die Taste **[START/IMPULS]** gedrückt, ohne dass der Parameter **PROG STO** ausgewählt ist, so werden die Einstellungen immer auf Programmplatz # gespeichert.

 Die vorherigen Daten des Programmplatzes werden beim Speichern überschrieben.

16.2 Programm-Abruf

- Mit der Taste **[SELECT]** den Parameter **PROG RCL** auswählen und mit dem Drehknopf **○** den gewünschten Programmplatz einstellen.
- Die Taste **[START/IMPULS]** drücken. Die Zentrifugations-Daten des angewählten Programmplatzes werden angezeigt.
- Die Parameter können durch Drücken der Taste **[SELECT]** überprüft werden. Zum Verlassen der Parameter-Anzeige die Taste **[OPEN/STOP]** drücken oder 8 Sekunden lang keine Taste drücken.

17 Zentrifugation



Während eines Zentrifugationslaufes dürfen sich gemäß EN / IEC 61010-2-020, in einem Sicherheitsbereich von 300 mm um die Zentrifuge herum, keine Personen, Gefahrstoffe und Gegenstände befinden.



Wird der zulässige Gewichtsunterschied innerhalb der Beladung des Rotors überschritten, schaltet der Antrieb während des Anlaufs ab, und **IMBALANCE** wird angezeigt.

Ein Zentrifugationslauf kann jederzeit durch Drücken der Taste **OPEN/STOP** abgebrochen werden.

Während des Zentrifugationslaufes können alle Parameter angewählt und geändert werden (siehe Kapitel "Zentrifugations-Parameter eingeben").

Mit der Taste **RCF** kann jederzeit zwischen der RPM- und RCF-Anzeige umgeschaltet werden. Wird mit der RCF-Anzeige gearbeitet, ist die Eingabe des Zentrifugerradius notwendig.

Wird **OPEN** angezeigt, so ist eine weitere Bedienung der Zentrifuge erst nach einmaligem Öffnen des Deckels möglich.

Wird **R xx n-max xxxxx** angezeigt, so hat kein Zentrifugationslauf stattgefunden, weil zuvor der Rotor gewechselt wurde, siehe Kapitel "Rotor-Erkennung".

- Den Netzschalter einschalten. Schalterstellung I.
- Den Rotor beladen und den Zentrifugendeckel schließen.

17.1 Zentrifugation mit Zeitvorwahl

- Eine Zeit einstellen oder ein Programm mit Zeitvorwahl abrufen (siehe Kapitel "Programmierung").
- Die Taste **START/IMPULS** drücken. Die LED in der Taste **START/IMPULS** leuchtet solange der Rotor dreht.
- Nach Ablauf der Zeit oder bei Abbruch des Zentrifugationslaufes durch Drücken der Taste **OPEN/STOP**, erfolgt der Auslauf mit der angewählten Bremsstufe. Die Bremsstufe wird angezeigt.

Während des Zentrifugationslaufes werden die Drehzahl des Rotors oder der daraus resultierende RCF-Wert, die Proben-Temperatur (nur bei Zentrifuge mit Kühlung), und die verbleibende Zeit angezeigt.

17.2 Dauerlauf

- Das Symbol ∞ einstellen oder ein Dauerlauf-Programm abrufen (siehe Kapitel "Programmierung").
- Die Taste **START/IMPULS** drücken. Die LED in der Taste **START/IMPULS** leuchtet solange der Rotor dreht. Die Zeitzählung beginnt bei 00:00.
- Die Taste **OPEN/STOP** drücken um den Zentrifugationslauf zu beenden. Der Auslauf erfolgt mit der angewählten Bremsstufe. Die Bremsstufe wird angezeigt.

Während des Zentrifugationslaufes werden die Drehzahl des Rotors oder der daraus resultierende RCF-Wert, die Proben-Temperatur (nur bei Zentrifuge mit Kühlung), und die gelaufene Zeit angezeigt.

17.3 Kurzzeitzentrifugation

- Die Taste **START/IMPULS** gedrückt halten. Die LED in der Taste **START/IMPULS** leuchtet solange der Rotor dreht. Die Zeitzählung beginnt bei 00:00.
- Die Taste **START/IMPULS** wieder loslassen um den Zentrifugationslauf zu beenden. Der Auslauf erfolgt mit der angewählten Bremsstufe. Die Bremsstufe wird angezeigt.

Während des Zentrifugationslaufes werden die Drehzahl des Rotors oder der daraus resultierende RCF-Wert, die Proben-Temperatur (nur bei Zentrifuge mit Kühlung), und die gelaufene Zeit angezeigt.

18 Not-Stop

- Die Taste **OPEN/STOP** 2x drücken.

Beim Not-Stop erfolgt der Auslauf mit Bremsstufe 9 (kürzeste Auslaufzeit). Die Bremsstufe 9 wird angezeigt. War die Bremsstufe 0 vorgewählt, so ist die Auslaufzeit technisch bedingt länger als mit Bremsstufe 9.

19 Akustisches Signal

Das akustische Signal ertönt:

- bei Auftreten einer Störung im 2 s-Intervall.
- nach Beendigung des Zentrifugationslaufes und Stillstand des Rotors im 30 s-Intervall.

Durch Öffnen des Deckels oder Drücken einer beliebigen Taste wird das akustische Signal beendet.

Das Signal nach Beendigung des Zentrifugationslaufes kann, bei Stillstand des Rotors, folgendermaßen aktiviert oder deaktiviert werden:

- Die Taste **[SELECT]** 8 s gedrückt halten.
Nach 8 s erscheint **SOUND / BELL** in der Anzeige.
- Mit dem Drehknopf **⊖** **OFF** (aus) oder **ON** (ein) einstellen.
- Die Taste **[START/IMPULS]** drücken um die Einstellung zu speichern.
Als Bestätigung wird kurzzeitig ***** ok ***** angezeigt.

20 Betriebsstunden-Abfrage

Die Abfrage der Betriebsstunden ist nur bei Stillstand des Rotors möglich.

- Die Taste **[SELECT]** 8 s gedrückt halten.
Nach 8 s erscheint **SOUND / BELL** in der Anzeige.
- Die Taste **[SELECT]** nochmals drücken.
Die Betriebsstunden (**CONTROL:**) der Zentrifuge werden angezeigt.
- Zum Verlassen der Betriebsstunden-Abfrage die Taste **[OPEN/STOP]** drücken.

21 Kühlung (nur bei Zentrifuge mit Kühlung)

Der Temperatur-Sollwert kann von -20°C bis +40°C eingestellt werden. Die tiefste erreichbare Temperatur ist rotorabhängig (siehe Kapitel "Anhang/Appendix, Rotoren und Zubehör/Rotors and accessories").

21.1 Standby-Kühlung

Bei Stillstand des Rotors und geschlossenem Deckel wird der Schleuderraum auf die vorgewählte Temperatur gekühlt. Im Display wird der Temperatur-Sollwert angezeigt.

Nach einem Zentrifugationslauf erfolgt die Standby-Kühlung zeitverzögert, und im Display wird **⏸ OPEN ⏸ OEFFNEN** angezeigt. Die Verzögerungszeit ist von 1 bis 5 Minuten, in 1 Minuten-Schritten einstellbar. Sie ist auf 1 Minute voreingestellt.

Die Verzögerungszeit kann, bei Stillstand des Rotors und geöffnetem Deckel, folgendermaßen eingestellt werden:

- Die Taste **[X]** 8 Sekunden gedrückt halten.
Nach 8 Sekunden erscheint **t/min = X** in der Anzeige.
- Mit dem Drehknopf **⊖** die Verzögerungszeit einstellen.
- Die Taste **[START/IMPULS]** drücken, um die Einstellung zu speichern.
Als Bestätigung wird kurzzeitig ***** ok ***** angezeigt.

Zum Verlassen der Verzögerungszeit-Anzeige die Taste **[OPEN/STOP]** drücken oder 8 Sekunden lang keine Taste drücken.

21.2 Vorkühlen des Rotors

- Die Taste **[X]** drücken. Die LED in der Taste **[START/IMPULS]** leuchtet solange der Rotor dreht.
- Die Taste **[OPEN/STOP]** drücken um die Vorkühlung zu beenden. Der Auslauf erfolgt mit der angewählten Bremsstufe. Die Bremsstufe wird angezeigt.

Während des Zentrifugationslaufes werden die Drehzahl des Rotors oder der daraus resultierende RCF-Wert, die Proben-Temperatur, und die gelaufene Zeit angezeigt.

Die Vorkühl-Drehzahl ist von 500 RPM bis zur maximalen Drehzahl der Rotors, in 10er Schritten einstellbar. Sie ist voreingestellt auf 2800 RPM.

Die Vorkühl-Drehzahl kann, bei Stillstand des Rotors und geöffnetem Deckel, folgendermaßen eingestellt werden:

- Die Taste **[X]** 8 Sekunden gedrückt halten.
Nach 8 Sekunden erscheint **t/min = X** in der Anzeige.
- Die Taste **[X]** nochmals drücken.
Die eingestellte Vorkühl-Drehzahl **RPM = XXXX** wird angezeigt.
- Mit dem Drehknopf **⊖** die gewünschte Vorkühl-Drehzahl einstellen.
- Die Taste **[START/IMPULS]** drücken, um die Einstellung zu speichern.
Als Bestätigung wird kurzzeitig ***** ok ***** angezeigt.

Zum Verlassen der Vorkühl-Drehzahl-Anzeige die Taste **[OPEN/STOP]** drücken oder 8 Sekunden lang keine Taste drücken.

22 Relative Zentrifugalbeschleunigung (RCF)

Die relative Zentrifugalbeschleunigung (RCF) wird als Vielfaches der Erdbeschleunigung (g) angegeben. Sie ist ein einheitsfreier Zahlenwert und dient zum Vergleich der Trenn- und Sedimentationsleistung.

Die Berechnung erfolgt nach der Formel:

$$\text{RCF} = \left(\frac{\text{RPM}}{1000} \right)^2 \times r \times 1,118 \quad \Rightarrow \quad \text{RPM} = \sqrt{\frac{\text{RCF}}{r \times 1,118}} \times 1000$$

RCF = Relative Zentrifugalbeschleunigung

RPM = Drehzahl

r = Zentrifugerradius in mm = Abstand von der Mitte der Drehachse bis zum Zentrifugiergefäßboden.
Zentrifugerradius siehe Kapitel "Anhang/Appendix, Rotoren und Zubehör/
Rotors and accessories".



Die relative Zentrifugalbeschleunigung (RCF) ist von der Drehzahl und dem Zentrifugerradius abhängig.

23 Zentrifugation von Stoffen oder Stoffgemischen mit einer höheren Dichte als 1,2 kg/dm³

Bei der Zentrifugation mit maximaler Drehzahl darf die Dichte der Stoffe oder Stoffgemische 1,2 kg/dm³ nicht überschreiten.

Bei Stoffen oder Stoffgemischen mit einer höheren Dichte muss die Drehzahl reduziert werden.

Die erlaubte Drehzahl lässt sich nach folgender Formel berechnen:

$$\text{Reduzierte Drehzahl (n}_{\text{red}}) = \sqrt{\frac{1,2}{\text{höhere Dichte [kg/dm}^3]}} \times \text{maximale Drehzahl [RPM]}$$

z.B.: Maximale Drehzahl 4000 RPM, Dichte 1,6 kg/dm³

$$n_{\text{red}} = \sqrt{\frac{1,2 \text{ kg/dm}^3}{1,6 \text{ kg/dm}^3}} \times 4000 \text{ RPM} = 3464 \text{ RPM}$$

Wird im Ausnahmefall die, auf dem Gehänge angegebene, maximale Beladung überschritten, muss die Drehzahl ebenfalls reduziert werden.

Die erlaubte Drehzahl lässt sich nach folgender Formel berechnen:

$$\text{Reduzierte Drehzahl (n}_{\text{red}}) = \sqrt{\frac{\text{maximale Beladung [g]}{\text{tatsächliche Beladung [g]}}} \times \text{maximale Drehzahl [RPM]}$$

z.B.: Maximale Drehzahl 4000 RPM, maximale Beladung 300 g, tatsächliche Beladung 350 g

$$n_{\text{red}} = \sqrt{\frac{300 \text{ g}}{350 \text{ g}}} \times 4000 \text{ RPM} = 3703 \text{ RPM}$$

Bei eventuellen Unklarheiten ist Auskunft beim Hersteller einzuholen.

24 Rotorerkennung

Nach Start eines jeden Zentrifugationslaufes wird eine Rotorerkennung durchgeführt.

Wurde der Rotor gewechselt, wird der Zentrifugationslauf nach der Rotorerkennung abgebrochen. Der Rotorcode (rot xx) des Rotors wird angezeigt. Der Rotorcode (R xx) sowie die maximale Drehzahl (n-max=xxxxx) des Rotors werden angezeigt.



Eine weitere Bedienung der Zentrifuge ist erst nach einmaligem Öffnen des Deckels möglich.

Wenn die maximale Drehzahl des verwendeten Rotors kleiner als die eingestellte Drehzahl ist, wird die Drehzahl auf die maximale Drehzahl des Rotors begrenzt.

25 Notentriegelung

Bei einem Stromausfall kann der Deckel nicht motorisch entriegelt werden. Es muss eine Notentriegelung von Hand durchgeführt werden.



Zur Notentriegelung die Zentrifuge vom Netz trennen.
Den Deckel nur bei Stillstand des Rotors öffnen.

Siehe Abbildung auf Seite 2.

- Den Netzschalter ausschalten (Schalterstellung "0").
- Durch das Fenster im Deckel schauen, um sich zu vergewissern, dass der Rotor stillsteht.
- Den Sechskant-Stiftschlüssel waagrecht in die Bohrung (Fig. 1, A) einführen und vorsichtig eine halbe Umdrehung im Uhrzeigersinn drehen, bis sich der Deckel öffnen lässt.
- Den Sechskant-Stiftschlüssel wieder aus der Bohrung herausziehen.
- Wenn nach dem Wiedereinschalten der Zentrifuge die linke LED in der Taste **OPEN / STOP** blinkt, die Taste **OPEN / STOP** drücken, dass die motorische Deckelverriegelung wieder die Grundstellung (geöffnet) einnimmt.

26 Pflege und Wartung



Das Gerät kann kontaminiert sein.



Vor der Reinigung den Netzstecker ziehen.

Bevor ein anderes als das vom Hersteller empfohlene Reinigungs- oder Dekontaminationsverfahren angewandt wird, hat sich der Benutzer beim Hersteller zu vergewissern, dass das vorgesehene Verfahren das Gerät nicht schädigt.

- Zentrifugen, Rotoren und das Zubehör dürfen nicht in Spülmaschinen gereinigt werden.
- Es darf nur eine Handreinigung und eine Flüssig-Desinfektion durchgeführt werden.
- Die Wassertemperatur muss 20 – 25°C betragen.
- Es dürfen nur Reinigungs- oder Desinfektionsmittel verwendet werden, die:
 - im pH-Bereich 5 - 8 liegen,
 - keine Ätzalkalien, Peroxide, Chlorverbindungen, Säuren und Laugen enthalten.
- Um Korrosionserscheinungen durch Reinigungs- oder Desinfektionsmittel zu vermeiden sind die speziellen Anwendungshinweise vom Hersteller des Reinigungs- oder Desinfektionsmittels unbedingt zu beachten.

26.1 Zentrifuge (Gehäuse, Deckel und Schleuderraum)

26.1.1 Oberflächenreinigung und -pflege

- Das Gehäuse der Zentrifuge und den Schleuderraum regelmäßig säubern und bei Bedarf mit Seife oder einem milden Reinigungsmittel und einem feuchten Tuch reinigen. Dies dient zum einen der Hygiene und es verhindert Korrosion durch anhaftende Verunreinigungen.
- Inhaltsstoffe geeigneter Reinigungsmittel:
Seife, anionische Tenside, nichtionische Tenside.
- Nach dem Einsatz von Reinigungsmitteln, die Reste des Reinigungsmittels, durch Nachwischen mit einem feuchten Tuch, entfernen.
- Die Flächen müssen unmittelbar nach der Reinigung getrocknet werden.
- Bei Bildung von Kondenswasser den Schleuderraum, durch Auswischen mit einem saugfähigen Tuch, trocknen.
- Die Gummidichtung des Schleuderraums nach jeder Reinigung mit Talkum-Puder oder einem Gummi-Pflegemittel leicht einreiben.
- Der Schleuderraum ist jährlich auf Schäden zu überprüfen.



Werden sicherheitsrelevante Schäden festgestellt, darf die Zentrifuge nicht mehr in Betrieb genommen werden. In diesem Fall ist der Kundendienst zu benachrichtigen.

26.1.2 Oberflächendesinfektion

- Gelangt infektiöses Material in den Schleuderraum, so ist dieser umgehend zu desinfizieren.
- Inhaltsstoffe geeigneter Desinfektionsmittel:
Äthanol, n-Propanol, Ethylhexanol, anionische Tenside, Korrosionsinhibitoren.
- Nach dem Einsatz von Desinfektionsmitteln, die Reste des Desinfektionsmittels, durch Nachwischen mit einem feuchten Tuch, entfernen.
- Die Flächen müssen unmittelbar nach der Desinfektion getrocknet werden.

26.1.3 Entfernen radioaktiver Verunreinigungen

- Das Mittel muss speziell für das Entfernen radioaktiver Verunreinigungen ausgewiesen sein.
- Inhaltsstoffe geeigneter Mittel für das Entfernen radioaktiver Verunreinigungen:
Anionische Tenside, nichtionische Tenside, polyhydrierter Äthanol.
- Nach dem Entfernen der radioaktiven Verunreinigungen, die Reste des Mittels, durch Nachwischen mit einem feuchten Tuch, entfernen.
- Die Flächen müssen unmittelbar nach dem Entfernen der radioaktiven Verunreinigungen getrocknet werden.

26.2 Rotoren und Zubehör

26.2.1 Reinigung und Pflege

- Um einer Korrosion und Materialveränderungen vorzubeugen müssen die Rotoren und das Zubehör regelmäßig mit Seife oder einem milden Reinigungsmittel und einem feuchten Tuch gereinigt werden. Die Reinigung wird mindestens einmal wöchentlich empfohlen. Verschmutzungen müssen sofort entfernt werden.
- Inhaltsstoffe geeigneter Reinigungsmittel:
Seife, anionische Tenside, nichtionische Tenside.
- Nach dem Einsatz von Reinigungsmitteln, die Reste des Reinigungsmittels, durch Nachspülen mit Wasser (nur außerhalb der Zentrifuge) oder Nachwischen mit einem feuchten Tuch, entfernen.
- Die Rotoren und das Zubehör müssen unmittelbar nach der Reinigung getrocknet werden.
- Winkelrotoren, Behälter und Gehänge aus Aluminium sind nach dem Trocknen mit säurefreiem Fett z.B. Vaseline leicht einzufetten.
- Bei Bio-Sicherheitssystemen sind die Dichtungsringe wöchentlich zu reinigen.
Die Dichtungsringe sind aus Silikon hergestellt. Um die Dichtigkeit der Bio-Sicherheitssysteme zu gewährleisten, dürfen die Dichtungsringe nach der Reinigung oder nach dem Autoklavieren nicht mit Talkum-Puder behandelt werden.
Vor jedem Gebrauch des Bio-Sicherheitssystems müssen alle Teile des Bio-Sicherheitssystems visuell auf Beschädigung überprüft werden. Außerdem muss die korrekte Einbaulage des Dichtungsringes bzw. der Dichtungsringe des Bio-Sicherheitssystems überprüft werden.
Die beschädigten Teile des Bio-Sicherheitssystems müssen sofort ausgetauscht werden.
Bei Anzeichen von Rissbildung, Versprödung oder Abnutzung ist der betreffende Dichtungsring sofort auszutauschen. Bei Deckeln mit nicht auswechselbaren Dichtungsringen muss der gesamte Deckel ausgetauscht werden.
Lieferbare Bio-Sicherheitssysteme siehe Kapitel "Anhang/Appendix, Rotoren und Zubehör/Rotors and accessories".
- Um Korrosion infolge Feuchtigkeit zwischen Rotor und Motorwelle zu verhindern, sollte der Rotor mindestens einmal im Monat ausgebaut, gereinigt und die Motorwelle leicht gefettet werden.
- Die Rotoren und das Zubehör sind wöchentlich auf Verschleiß und Korrosionsschäden zu überprüfen.
Bei Ausschwingrotoren muss vor allem der Bereich der Tragzapfen und bei Gehängen die Nuten und der Boden auf Risse geprüft werden.
Beispiel: Riss im Bereich der Nut:

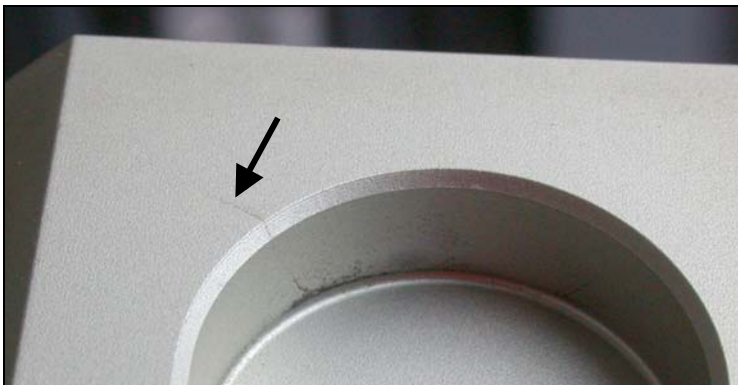

Rotoren und Zubehör dürfen bei Anzeichen von Verschleiß oder Korrosion nicht mehr verwendet werden.

- Den Rotor wöchentlich auf festen Sitz prüfen.

26.2.2 Desinfektion

- Gelangt infektiöses Material auf die Rotoren oder auf das Zubehör, so muss eine geeignete Desinfektion durchgeführt werden.
- Inhaltsstoffe geeigneter Desinfektionsmittel:
Äthanol, n-Propanol, Ethylhexanol, anionische Tenside, Korrosionsinhibitoren.
- Nach dem Einsatz von Desinfektionsmitteln, die Reste des Desinfektionsmittels, durch Nachspülen mit Wasser (nur außerhalb der Zentrifuge) oder Nachwischen mit einem feuchten Tuch, entfernen.
- Die Rotoren und das Zubehör müssen unmittelbar nach der Desinfektion getrocknet werden.

26.2.3 Entfernen radioaktiver Verunreinigungen

- Das Mittel muss speziell für das Entfernen radioaktiver Verunreinigungen ausgewiesen sein.
- Inhaltsstoffe geeigneter Mittel für das Entfernen radioaktiver Verunreinigungen: Anionische Tenside, nichtionische Tenside, polyhydrierter Äthanol.
- Nach dem Entfernen der radioaktiven Verunreinigungen, die Reste des Mittels, durch Nachspülen mit Wasser (nur außerhalb der Zentrifuge) oder Nachwischen mit einem feuchten Tuch, entfernen.
- Die Rotoren und das Zubehör müssen unmittelbar nach dem Entfernen der radioaktiven Verunreinigungen getrocknet werden.

26.2.4 Tragzapfen

Bei Ausschwingrotoren müssen die Tragzapfen regelmäßig gefettet werden (Hettich-Schmierfett Nr. 4051), um ein gleichmäßiges Ausschwingen der Gehänge zu gewährleisten.

26.2.5 Rotoren und Zubehör mit begrenzter Verwendungsdauer

Die Verwendung von bestimmten Rotoren, Gehängen und Zubehörteilen ist zeitlich begrenzt.

Diese sind mit der maximal erlaubten Anzahl der Laufzyklen oder dem Ablaufdatum und der maximalen Anzahl der Laufzyklen oder nur mit dem Ablaufdatum gekennzeichnet, z.B.:

- "einsetzbar bis Ende: IV. Quartal 2011 / usable until end of: IV. Quartal 2011" oder "einsetzbar bis Ende Monat/Jahr: 10/2011 / usable until end of month/year: 10/2011"
- "max. Laufzyklen / max. cycles: 40000".



Aus Sicherheitsgründen dürfen die Rotoren, Gehänge und Zubehörteile nicht mehr verwendet werden, wenn entweder die darauf gekennzeichnete maximal erlaubte Anzahl der Laufzyklen oder das darauf gekennzeichnete Ablaufdatum erreicht ist.

26.3 Autoklavieren

Das folgende Zubehör darf bei 121°C / 250°F (20 min) autoklaviert werden:

- Ausschwingrotoren
- Winkelrotoren aus Aluminium
- Gehänge aus Metall
- Deckel mit Bioabdichtung
- Adapter

Über den Sterilitätsgrad kann keine Aussage gemacht werden.



Die Deckel der Rotoren und Behälter müssen vor dem Autoklavieren abgenommen werden.

Das Autoklavieren beschleunigt den Alterungsprozess von Kunststoffen. Außerdem kann es bei Kunststoffen Farbveränderungen verursachen.

Der Deckel der Rotoren 1515 und 1515-A darf nur 10 mal autoklaviert werden. Anschließend muss er aus Sicherheitsgründen ausgetauscht werden.

Nach dem Autoklavieren sind die Rotoren und das Zubehör visuell auf Beschädigung zu überprüfen und eventuell beschädigte Teile sofort auszutauschen.

Bei Anzeichen von Rissbildung, Versprödung oder Abnutzung ist der betreffende Dichtungsring sofort auszutauschen.

Bei Deckeln mit nicht auswechselbaren Dichtungsringen muss der gesamte Deckel ausgetauscht werden.

Um die Dichtigkeit der Bio-Sicherheitssysteme zu gewährleisten, dürfen die Dichtungsringe nach dem Autoklavieren nicht mit Talkum-Puder behandelt werden.

26.4 Zentrifugiergefäße

- Bei Undichtigkeit oder nach dem Bruch von Zentrifugiergefäßen, sind zerbrochene Gefäßteile, Glassplitter und ausgelaufenes Zentrifugiergut vollständig zu entfernen.
- Die Gummieinlagen sowie die Kunststoff-Hülsen der Rotoren sind nach einem Glasbruch zu ersetzen.



Verbleibende Glassplitter verursachen weiteren Glasbruch !

- Handelt es sich um infektiöses Material so ist umgehend eine Desinfektion durchzuführen.

27 Störungen

Lässt sich der Fehler laut Störungstabelle nicht beheben, so ist der Kundendienst zu benachrichtigen.

Bitte den Zentrifugentyp und die Seriennummer angeben. Beide Nummern sind auf dem Typenschild der Zentrifuge ersichtlich.



Einen NETZ-RESET durchführen:

- Den Netzschalter ausschalten (Schalterstellung "0").
- Mindestens 10 Sekunden lang warten und anschließend den Netzschalter wieder einschalten (Schalterstellung "I").

Anzeige		Ursache	Beseitigung
keine Anzeige	---	keine Spannung. Auslösen der Überstromsichersicherung.	- Versorgungsspannung überprüfen. - Netzschalter EIN.
TACHO - ERROR	1, 2, 96	Tacho defekt. Motor, Elektronik defekt.	- Deckel öffnen. - Den Netzschalter ausschalten (Schalterstellung "0"). - Mindestens 10 Sekunden lang warten. - Den Rotor von Hand kräftig drehen. - Den Netzschalter wieder einschalten (Schalterstellung "I"). Während des Einschaltens muss sich der Rotor drehen
CONTROL - ERROR	8	Fehler Deckelverriegelung	
IMBALANCE	---	Der Rotor ist ungleichmäßig beladen.	- Deckel öffnen. - Die Beladung des Rotors überprüfen, siehe Kapitel "Beladen des Rotors". - Den Zentrifugationslauf wiederholen.
CONTROL - ERROR	4, 6	Fehler Deckelverriegelung	- Einen NETZ-RESET durchführen.
N > MAX	5	Überdrehzahl	
N < MIN	13	Unterdrehzahl	
MAINS INTERRUPT	---	Netzunterbrechung während des Zentrifugationslaufes. (Der Zentrifugationslauf wurde nicht beendet.)	- Deckel öffnen. - Taste START / IMPULS drücken. - Bei Bedarf den Zentrifugationslauf wiederholen.
ROTORCODE	10.1, 10.2	Fehler Rotorcodierung	- Deckel öffnen.
CONTROL-ERROR	21, 22, 25, 27, 29	Fehler / Defekt Elektronik	- Einen NETZ-RESET durchführen.
CONTROL-ERROR	23	Fehler / Defekt Bedienteil	
SER I/O - ERROR	30, 31, 33, 36	Fehler / Defekt Elektronik	
° C * - ERROR	51 - 53, 55	Fehler / Defekt Elektronik	
FU / CCI - ERROR	60 - 64, 67, 68, 82 - 86	Fehler / Defekt Elektronik / Motor	
SYNC-ERROR	90	Fehler / Defekt Elektronik	
SENSOR-ERROR	91 - 93	Fehler / Defekt Unwuchtsensor	
KEYBOARD-ERROR	---	Fehler / Defekt Bedienteil	
NO ROTOR	---	Kein Rotor eingebaut	- Deckel öffnen. - Rotor einbauen.
N > ROTOR MAX	---	Drehzahl im angewählten Programm größer als die maximale Drehzahl des Rotors.	- Drehzahl überprüfen und korrigieren.
		Der Rotor wurde gewechselt. Der eingebaute Rotor hat eine höhere maximale Drehzahl als der vorher verwendete Rotor, und er wurde noch nicht von der Rotorerkennung erkannt.	- Eine Drehzahl, bis zur maximalen Drehzahl des vorher verwendeten Rotors, einstellen. Die Taste START / IMPULS drücken, um eine Rotorerkennung durchzuführen, siehe Kapitel "Rotorerkennung".

28 Rücksendung von Geräten



Vor der Rücksendung des Gerätes muss die Transportsicherung eingebaut werden.

Wird das Gerät oder dessen Zubehör an die Firma Andreas Hettich GmbH & Co. KG zurückgesandt, so muss dieses, zum Schutz von Personen, Umwelt und Material, vor dem Versand dekontaminiert und gereinigt werden.

Eine Annahme von kontaminierten Geräten oder Zubehör behalten wir uns vor.

Anfallende Kosten für Reinigungs- und Desinfektionsmaßnahmen werden dem Kunden in Rechnung gestellt.

Wir bitten dafür um Ihr Verständnis.

29 Entsorgung

Vor der Entsorgung muss das Gerät, zum Schutz von Personen, Umwelt und Material, dekontaminiert und gereinigt werden.

Bei der Entsorgung des Geräts sind die jeweiligen gesetzlichen Vorschriften zu beachten.

Gemäß der Richtlinie 2002/96/EG (WEEE) dürfen alle nach dem 13.08.2005 gelieferten Geräte nicht mehr mit dem Hausmüll entsorgt werden. Das Gerät gehört zur Gruppe 8 (Medizinische Geräte) und ist in den Business-to-Business-Bereich eingeordnet.



Mit dem Symbol des durchgestrichenen Abfalleimers wird darauf hingewiesen, dass das Gerät nicht mit dem Hausmüll entsorgt werden darf.

Die Entsorgungsvorschriften der einzelnen EU-Länder können unterschiedlich sein. Im Bedarfsfall wenden Sie sich bitte an Ihren Lieferanten.

Contents

1	Use according to specification	36
2	Remaining risks	36
3	Technical specifications	36
4	Notes on safety	39
5	Symbol meanings	41
6	Delivery checklist	41
7	Unpacking the centrifuge	41
8	Initial operation	42
9	Opening and closing the lid	42
9.1	Opening the lid	42
9.2	Closing the lid	42
10	Installation and removal of the rotor	43
10.1	Rotor with clamping nut	43
10.2	Rotor without clamping nut.....	43
10.2.1	Installing and removing the hub	43
10.2.2	Inserting and removing the rotor	43
11	Loading the rotor	44
12	Inserting the adapter with positioning pin into the hanger	45
13	Handling of bio-safety systems	45
13.1	Opening and closing the lid of bio-safety systems	45
13.1.1	Lid with screw top and hole in turning handle	45
13.1.2	Lid with screw closure.....	46
13.1.3	Lid with clamp and tension lock	46
13.2	Storage of bio-safety systems.....	46
14	Control and display elements	46
14.1	Control knob.....	47
14.2	Control panel pushbuttons (keys)	47
14.3	Adjustment possibilities.....	47
15	Entering centrifugation parameter	48
16	Programming.....	48
16.1	Programme input/alteration.....	48
16.2	Programme recall.....	48
17	Centrifugation	48
17.1	Centrifugation with pre-set time	49
17.2	Continuous run.....	49
17.3	Short-term centrifugation	49
18	Emergency Stop.....	49
19	Acoustic Signal.....	49
20	Recall hours of operation	49
21	Cooling (only in centrifuges with cooling)	50
21.1	Standby-cooling	50
21.2	Pre-cooling the rotor	50
22	Relative centrifugal force (RCF).....	50

23	Centrifugation of materials or mixtures of materials with a density higher than 1.2 kg/dm ³	51
24	Rotor recognition	51
25	Emergency release	51
26	Maintenance and servicing	52
26.1	Centrifuge (housing, lid and centrifuging chamber)	52
26.1.1	Surface cleaning and care	52
26.1.2	Surface disinfection	52
26.1.3	Removal of radioactive contaminants	52
26.2	Rotors and Attachments	53
26.2.1	Cleaning and care	53
26.2.2	Disinfection	53
26.2.3	Removal of radioactive contaminants	53
26.2.4	Trunnions	54
26.2.5	Rotors and accessories with limited service lives	54
26.3	Autoclaving	54
26.4	Centrifuge containers	54
27	Faults	55
28	Returning Devices	56
29	Disposal	56
30	Anhang / Appendix	106
30.1	Rotoren und Zubehör / Rotors and accessories	106

1 Use according to specification

This device is a medical product (laboratory centrifuge) within the context of the IVD Directive 98/79/EC.

The centrifuge was designed only for the separation of materials or mixtures with a density of no more than 1.2 kg/dm³. In particular, these include samples for preparation of in-vitro diagnostic purposes in human medicine.

The centrifuge is only meant for this purpose.

Another use or one which goes beyond this, is considered to be non-intended. The company Andreas Hettich GmbH & Co. KG is not liable for damage resulting from this.

Observing all information in the operating instructions and complying with the measures described therein is also a part of the intended use.

2 Remaining risks

The device is built according to the state-of-the-art and the recognized safety regulations. If used and handled improperly, there could be life-threatening danger to the user or third parties, or the device could be impaired or there could be other property damage. The device is only to be used for its intended purpose and only when it is in safe working condition.

Malfunctions which could affect safety must be corrected immediately.

3 Technical specifications

Manufacturer	Andreas Hettich GmbH & Co. KG D-78532 Tuttlingen				
Model	UNIVERSAL 320		UNIVERSAL 320 R		
Type	1401	1401-01	1406	1406-01	
Mains voltage (± 10%)	200-240 V 1~	100-127 V 1~	200-240 V 1~	240 V 1~	115-127 V 1~
Mains frequency	50 – 60 Hz	50 – 60 Hz	50 Hz	60 Hz	60 Hz
Connected load	400 VA	400 VA	800 VA		950 VA
Current consumption	2.0 A	4.0 A	4.0 A		8.0 A
Cooling medium	----		R 404A		
Max. capacity	4 x 200 ml				
Allowed density	1.2 kg/dm ³				
Speed (RPM)	16000				
Force (RCF)	24900				
Kinetic energy	9500 Nm				
Obligatory inspection (DGUV Regel 100 - 500)	no				
Ambient conditions (EN / IEC 61010-1)	Indoors only Up to 2000 m above sea level 2°C to 35°C 5°C to 35°C Maximum relative humidity 80% for temperatures up to 31°C, linearly decreasing to 50% relative humidity at 40°C.				
– Set-up site					
– Altitude					
– Ambient temperature					
– Humidity					
– Excess-voltage category (IEC 60364-4-443)	II				
– Pollution degree	2				
Device protection class	I				
Not suitable for use in explosion-endangered areas.					
EMC	EN / IEC 61326-1, Class B		FCC Class B	EN / IEC 61326-1, Class B FCC Class B	
– Emitted interference, Interference immunity					
Noise level (dependent on rotor)	≤ 68 dB(A)		≤ 64 dB(A)		
Dimensions					
– Width	401 mm		407 mm		
– Depth	529 mm		698 mm		
– Height	346 mm		346 mm		
Weight	approx. 31 kg		approx. 52 kg		

Manufacturer	Andreas Hettich GmbH & Co. KG D-78532 Tuttlingen			
Model	UNIVERSAL 320 R			
Type	1406-50	1406-51	1406-70	1406-71
Mains voltage ($\pm 10\%$)	200-240 V 1~	100-127 V 1~	200-240 V 1~	100-127 V 1~
Mains frequency	50 – 60 Hz	50 – 60 Hz	50 – 60 Hz	50 – 60 Hz
Connected load	400 VA	400 VA	400 VA	400 VA
Current consumption	2.0 A	4.0 A	2.0 A	4.0 A
Max. capacity	4 x 200 ml			
Allowed density	1.2 kg/dm ³			
Speed (RPM)	16000			
Force (RCF)	24900			
Kinetic energy	9500 Nm			
Obligatory inspection (DGUV Regel 100 - 500)	no			
Ambient conditions (EN / IEC 61010-1)	<p>Indoors only</p> <p>Up to 2000 m above sea level</p> <p>2°C to 35°C</p> <p>Maximum relative humidity 80% for temperatures up to 31°C, linearly decreasing to 50% relative humidity at 40°C.</p>			
– Set-up site				
– Altitude				
– Ambient temperature				
– Humidity				
– Excess-voltage category (IEC 60364-4-443)	II			
– Pollution degree	2			
Device protection class	I			
Not suitable for use in explosion-endangered areas.				
EMC				
– Emitted interference, Interference immunity	EN / IEC 61326-1, Class B	FCC Class B	EN / IEC 61326-1, Class B	FCC Class B
Noise level (dependent on rotor)	≤ 64 dB(A)			
Dimensions				
– Width	401 mm		401 mm	
– Depth	549 mm		550 mm	
– Height	346 mm		365 mm	
Weight	approx. 35 kg			

Manufacturer	Andreas Hettich GmbH & Co. KG D-78532 Tuttlingen		
Model	UNIVERSAL 320 R		
Type	1406-20	1406-21	
Mains voltage ($\pm 10\%$)	200-240 V 1~	240 V 1~	115-127 V 1~
Mains frequency	50 Hz	60 Hz	60 Hz
Connected load	800 VA		950VA
Current consumption	4.0 A		8.0 A
Cooling medium	R 404A		
Max. capacity	4 x 200 ml		
Allowed density	1.2 kg/dm ³		
Speed (RPM)	16000		
Force (RCF)	24900		
Kinetic energy	9500 Nm		
Obligatory inspection (DGUV Regel 100 - 500)	no		
Ambient conditions (EN / IEC 61010-1)	<p>Indoors only Up to 2000 m above sea level 5°C to 35°C Maximum relative humidity 80% for temperatures up to 31°C, linearly decreasing to 50% relative humidity at 40°C.</p>		
– Set-up site			
– Altitude			
– Ambient temperature			
– Humidity			
– Excess-voltage category (IEC 60364-4-443)	II		
– Pollution degree	2		
Device protection class	I		
Not suitable for use in explosion-endangered areas.			
EMC	EN / IEC 61326-1, Class B		FCC Class B
– Emitted interference, Interference immunity			
Noise level (dependent on rotor)	≤ 64 dB(A)		
Dimensions			
– Width	407 mm		
– Depth	725 mm		
– Height	365 mm		
Weight	approx. 52 kg		

4 Notes on safety



No claim of warranty will be considered by the manufacturer unless ALL instructions in this manual have been followed.



- The centrifuge should be installed on a good, stable base.
- Before using the centrifuge absolutely check the rotor for firm placement.
- When the centrifuge is running, according to EN / IEC 61010-2-020, no persons, dangerous substances or objects may be within the safety margin of 300 mm around the centrifuge.
- Rotors, suspensions and accessories that possess traces of corrosion or mechanical damage or if their term of use has expired may not be used any longer.
- The centrifuge may no longer be put into operation when the centrifuging chamber has safety-related damages.
- With swing-out rotors the trunnions must be regularly lubricated (Hettich Lubricating Grease No. 4051) in order to ensure consistent swinging out of the hangers.
- For centrifuges without temperature control, when the room temperature is increased and/or if the device is frequently used, the centrifuging chamber could be heated up. Therefore, it can't be ruled out that the sample material might be changed due to the temperature.

- Before the initial operation of your centrifuge you should read and pay attention to the operating instructions. Only personnel that has read and understood the operating instructions are allowed to operate the device.
- Along with the operating instructions and the legal regulations on accident prevention, you should also follow the recognised professional regulations for working in a safe and professional manner. These operating instructions should be read in conjunction with any other instructions concerning accident prevention and environmental protection based on the national regulations of the country where the device is to be used.
- This centrifuge is a state-of-the-art piece of equipment which is extremely safe to operate. However, it can lead to danger for users or others if used by untrained staff, in an inappropriate way or for a purpose other than that it was designed for.
- The centrifuge must not be moved or knocked during operation.
- In case of fault or emergency release, never touch the rotor before it has stopped turning.
- To avoid damage due to condensate, when changing from a cold to a warm room the centrifuge must either heat up for at least 3 hours in the warm room before being connected to the mains, or run hot for 30 minutes in the cold room.
- Only the rotors and accessories approved by the manufacturer for this device may be used (see chapter "Anhang/Appendix, Rotoren und Zubehör/Rotors and accessories"). Before centrifuge vessels are used which are not listed in the chapter "Appendix, Rotors and accessories", the user must make sure they can be used by asking the manufacturer.
- The centrifuge rotor may only be loaded in accordance with the chapter "Loading the rotor".
- When centrifuging with maxim revolutions per minute the density of the materials or the material mixtures may not exceed 1.2 kg/dm³.
- The centrifuge may only be operated when the balance is within the bounds of acceptability.
- The centrifuge may not be operated in explosion-endangered areas.
- The centrifuge must not be used with:
 - inflammable or explosive materials
 - materials that react with one another producing a lot of energy.

- When centrifuging hazardous substances or mixtures, which are toxic, radioactive or contaminated with pathogenic microorganisms, suitable measures must be taken by the user.
Fundamentally, centrifuge containers with special screw closures must be used for hazardous substances. For materials of risk groups 3 and 4, in addition to sealable centrifuge containers, a bio-safety system must be used (see the "Laboratory Bio-safety Manual" from the World Health Organization).
In a bio-safety system, a bio-seal (sealing ring) prevents droplets and aerosols from escaping.
If the hanger of a bio-safety system is used without the lid, the sealing ring must be removed from the hanger to prevent damage to the sealing ring during the centrifugation run.
Damaged bio-safety systems are no longer microbiologically sealed.
If a bio-safety system is not used, a centrifuge is not microbiologically sealed for the purposes of the standard EN / IEC 61010-2-020.
When closing a bio-safety system, follow the instructions in the chapter "Handling of bio-safety systems".
For the available bio-safety systems, see the chapter "Appendix, Rotors and accessories". If in doubt, you can get the information you need from the manufacturer.
- The centrifuge must not be operated with highly corrosive substances which could impair the mechanical integrity of rotors, hangers and accessories.
- Repairs must only be carried out by personnel authorised to do so by the manufacturer.
- Only original spare parts and original accessories licensed by the Andreas Hettich GmbH & Co. KG company are allowed to be utilised.
- The following safety regulations apply:
EN / IEC 61010-1 and EN / IEC 61010-2-020 as well as their national deviations.
- The safe operation and reliability of the centrifuge can only be guaranteed if:
 - the centrifuge is operated in accordance with the operating instructions,
 - the electrical installation on the site where the centrifuge is installed conforms to the demands of EN / IEC stipulations,
 - the tests for device safety required in the respective countries, e.g. in Germany in acc. with DGUV (Deutsche Gesetzliche Unfallversicherung or Engl.: German Statutory Accident Insurance) regulation 3, are carried out by an expert.

5 Symbol meanings



Symbol on the device:

Attention, general hazard area.

Before using the device, make sure you read the operating instructions and observe the safety information!



Symbol in this document:

Attention, general hazard area.

This symbol refers to safety relevant warnings and indicates possibly dangerous situations.

The non-adherence to these warnings can lead to material damage and injury to personal.



Symbol on the device and in this document:

Beware of biohazard.



Symbol in this document:

This symbol refers to important circumstances.



Symbol on the device and in this document:

Symbol for the separate collection of electric and electronic devices according to the guideline 2002/96/EG (WEEE). The device belongs to Group 8 (medical devices).

Applies in the countries of the European Union, as well as in Norway and Switzerland.

6 Delivery checklist

- 1 Connecting cable
- 1 Hexagonal pin-type spanner
- 1 Lubricating grease for trunnions
- 1 Operating instructions
- 1 Notes on moving the equipment safely

The rotor(s) and associated accessories are included in the delivery in the quantity ordered.

7 Unpacking the centrifuge

- Lift the carton upward and remove the padding.



Do not lift by the front panel.

Observe the weight of the centrifuge, refer to chapter "Technical specifications".

Lift the centrifuge on both sides with an appropriate number of helpers and place it on the laboratory table.

8 Initial operation

- Remove the transportation safety device from the bottom of the housing, see sheet "Transportation safety device"
- Position the centrifuge in a stable and level manner in a suitable place. During set-up, the required safety margin of 300 mm around the centrifuge is to be kept according to EN / IEC 61010-2-020.**



When the centrifuge is running, according to EN / IEC 61010-2-020, no persons, dangerous substances or objects may be within the safety margin of 300 mm around the centrifuge.

- Ventilation openings may not be blocked.
A distance of 300 mm must be maintained from the ventilation slots and openings of the centrifuge.
- In the case of the centrifuge, type 1406-20, 1406-21, connect the nitrogen supply according to the enclosed instruction sheet AH1406-20XX.
In the case of the centrifuge, type 1406-50, 1406-51, connect the refrigerating/heating circulator according to the enclosed instruction sheet AH1406-50XX.
In the case of the centrifuge, type 1406-70, 1406-71, connect the refrigerating/heating circulator and the nitrogen supply according to the enclosed instruction sheet AH1406-70XX.



It is mandatory that the centrifuge be connected according to the enclosed instruction sheet.
Make sure you observe the enclosed instruction sheet.

- Check whether the mains voltage tallies with the statement on the type plate.
- Connect the centrifuge with the power cord to a standard mains socket. For connection ratings refer to Chapter "Technical specifications".
- Turn on the mains switch. Switch position "I".
The machine type and program version will be displayed and the LEDs light up. After 8 seconds, **OPEN** **OEFFNEN** is displayed and the left LED on the **STOP/OPEN** key blinks.
- Open the lid.
The last used centrifuge data will be displayed.

9 Opening and closing the lid

9.1 Opening the lid



The lid can only be opened when the centrifuge is switched on and the rotor is at rest. If it cannot be opened under these circumstances, see the section on "Emergency release".

- Press the button **OPEN/STOP**. The lid unlocks via the motor and the left LED in the pushbutton **OPEN/STOP** extinguishes.

9.2 Closing the lid



Do not put your fingers between lid and housing.
Do not bang the lid shut.

If the left LED in the **OPEN/STOP** button flashes, press the **OPEN/STOP** button so that the motor-driven lid lock goes into the basic position (opened).

- Place the lid and lightly press down the front edge of the lid. The locking action is effected by motor. The left LED in the button **OPEN/STOP** lights up.

10 Installation and removal of the rotor

10.1 Rotor with clamping nut

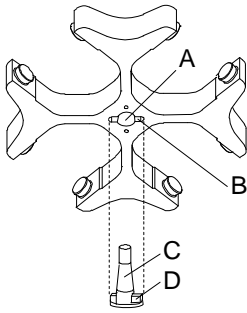

Rotor installation:



Dirt particles between the motor shaft and rotor prevent the rotor from having a perfect seat and cause it to run unsteadily.

- Clean the motor shaft (C) and the bore of the rotor (A) and then apply a thin coat of grease to the motor shaft.
- Place the rotor vertically onto the motor shaft. The driver of the motor shaft (D) must be in the groove of the rotor (B). The groove alignment is marked on the rotor.
- Tighten the clamping nut of the rotor by turning it in the clockwise direction using the key included in delivery.
- Check the rotor to make sure it is seated firmly.

Removing the rotor:

- Loosen the clamping nut by turning it in the counterclockwise direction up to the lifting pressure point. After overcoming the lifting pressure point, the rotor is released from the cone of the motor shaft.
- Turn the clamping nut until the rotor can be lifted up from the motor shaft.

10.2 Rotor without clamping nut

10.2.1 Installing and removing the hub

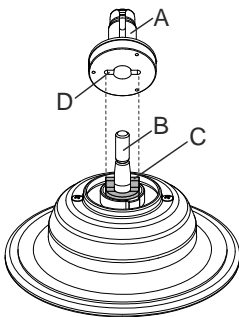

Installing the hub:

- Place the hub (A) vertically onto the motor shaft (B). The driver (C) on the motor shaft must be in the groove (D) of the hub.
- Tighten the clamping nut of the hub by turning it in the clockwise direction using the Allen key included in delivery.
- Check the hub to make sure it has a firm fit.

Removing the hub:

- Remove the rotor.
- Loosen the clamping nut of the hub by turning it counterclockwise up to the lifting pressure point. After overcoming the lifting pressure point, the hub is released from the cone of the motor shaft.
- Turn the clamping nut until the hub can be lifted up from the motor shaft.

10.2.2 Inserting and removing the rotor

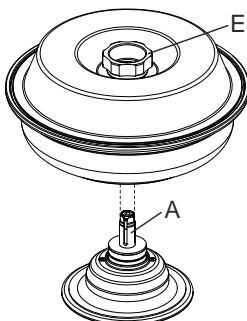

Inserting the rotor:



Dirt particles between the hub and rotor prevent the rotor from having a perfect seat and cause it to run unsteadily. If necessary, clean the hub (A) on the motor shaft and the rotor hub before inserting the rotor.

- Lift up the rotor by the turning handle (E) of the lid, place it horizontally on the hub (A) and press it down as far as it can go.

Removing the rotor:

- Hold firmly onto the rotor by the turning handle (E) of the lid and lift it off of the hub (A).

11 Loading the rotor



Standard centrifuge containers of glass will not stand RCF values exceeding 4000 (DIN 58970, pg. 2).

- Check the rotor for firm seating.
- With swing-out rotors all rotor positions must be lined with **identical** hangers. Certain hangers are marked with the number of the rotor position. These hangers may only be used in the respective rotor position. Hangers that are marked with a set number (e.g. S001/4) may only be used in the set.
- The rotors and hangers may only be loaded symmetrically. The centrifuge containers have to be distributed evenly on all rotor positions. For authorised combinations see Chapter "Anhang/Appendix, Rotoren und Zubehör/Rotors and accessories".
In the case of angle rotors all possible rotor positions must be loaded, see chapter "Anhang/Appendix, Rotoren und Zubehör/Rotors and accessories".

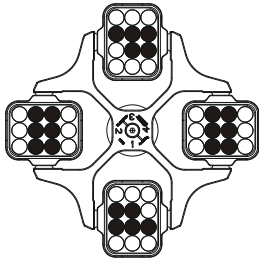

Rotor is evenly loaded

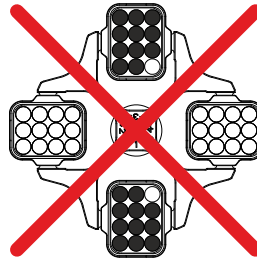

Not permitted!

Rotor is not evenly loaded

- On certain hangers, the weight of the maximum load or the weight of the maximum load and the maximum weight of the completely loaded hanger is specified. This weight may not be exceeded. In case of exception, see chapter "Centrifugation of materials or mixtures of materials with a density higher than 1.2 kg/dm^3 ". The weight specification of the maximum load includes the total weight of the adapter, centrifuge container and contents.
- In containers with rubber inserts, the same number of rubber inserts must always be among the centrifuge containers.
- The centrifuge containers may only be filled outside of the centrifuge.
- The maximum filling quantity for the centrifuge containers specified by the manufacturer must not be exceeded.

In the case of angle rotors, the centrifuging vessels may only be filled so far that no fluid can be expelled from them while the centrifuge is running.

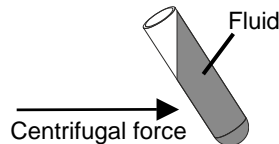

- When loading the angle rotors, no liquid may get into the angle rotors or centrifuging chamber.
- When loading the hangers and swing-out rotors and when swivelling out the hangers while the centrifuge is running, no liquid may enter the hangers or the centrifuging chamber.
- In order to maintain the weight differences within the centrifuge container as marginal as possible, a consistent fill level in the containers is to be heeded.

12 Inserting the adapter with positioning pin into the hanger

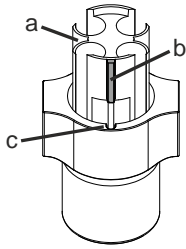

- Insert the adapter (a) into the hanger such that the positioning pin (b) is in the groove (c) of the hanger.



If the adapter (a) is not correctly inserted, the centrifuge containers could be damaged during the centrifugation run.

13 Handling of bio-safety systems



Bio-safety systems may only be used when they are dry.

Each time before using the bio-safety system, all parts of the bio-safety system must be visually inspected for damage. In addition, the sealing ring(s) of the bio-safety system must be checked to make sure they are in the correct installation position.

Damaged parts of the bio-safety system must be exchanged immediately.

Damaged bio-safety systems are no longer microbiologically sealed.

To ensure leak-tightness, the lid of the bio-safety system must be correctly sealed.

For the available bio-safety systems, see the chapter "Appendix, Rotors and accessories". If in doubt, you can get the information you need from the manufacturer.

13.1 Opening and closing the lid of bio-safety systems

13.1.1 Lid with screw top and hole in turning handle

Closing the lid:

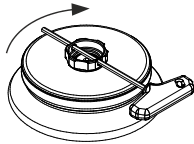

- Place the lid centred on the rotor.
- Stick the supplied key through the hole in the turning handle and close the lid firmly by turning the key in a clockwise direction.

Opening the lid:

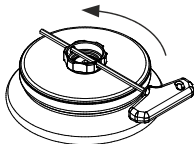

- Stick the supplied key through the hole in the turning handle and turn counter-clockwise until the lid can be removed from the rotor.

13.1.2 Lid with screw closure

Closing the lid:

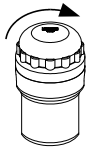

- Place the lid on the hanger.
- Tightly seal the lid by hand by turning it clockwise.

Opening the lid:

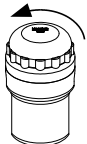

- Turn the lid by hand counterclockwise until the lid can be removed from the hanger.

13.1.3 Lid with clamp and tension lock

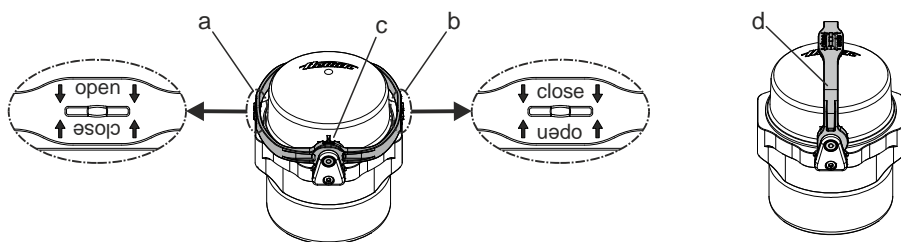

Closing the lid:

- Swivel the clamp in the "↓ open ↓" (a) position. The arrows of the "↓ open ↓" label must be pointing downwards so that the text "open" is legible.
- Place the lid on the hanger such that the two pins of the lid are in the two openings of the clamp (c).
- Swivel the clamp to the opposite side of the hanger to the "↓ close ↓" (b) position. The arrows of the "↓ close ↓" must be pointing downwards so that the text "close" is legible.



The clamp must lie on the hanger so that it can swing out during the centrifugation run.

- If the clamp is swivelled into position (d), the bio-safety system can be carried by the clamp.



The leak-tightness of the bio-safety system is also ensured in the carry position.

During transportation, do not swing the bio-safety system back and forth, since otherwise, leak-tightness can no longer be guaranteed.

- For easier handling when inserting and removing the hanger, swivel the clamp into position (d) and hold the hanger on the clamp.

Opening the lid:

- Swivel the clamp in the "↓ open ↓" (a) position. The arrows of the "↓ open ↓" label must be pointing downwards so that the text "open" is legible.
- Remove the lid from the hanger.

13.2 Storage of bio-safety systems

- To prevent damage to the sealing rings during storage, bio-safety systems may only be stored with the lid open.

14 Control and display elements

See figure on page 2.

Fig. 2, Fig. 3: Display and control panel

14.1 Control knob



For setting the individual parameters.
Turning anticlockwise reduces the value. Turning clockwise increases the value.

14.2 Control panel pushbuttons (keys)



- Selection control key for selection of specific parameter.
The subsequent parameter is selected by every further keystroke.



- Start centrifugation run. The LED in the button lights up during the centrifugation run as long as the rotor is turning.
- Short-term centrifugation.
The centrifugation run is effected as long as the button is held down. The LED in the button lights up during the centrifugation run as long as the rotor is turning.
- Store inputs and changes.



- End centrifugation run.
The rotor runs down with a pre-selected brake step. The right-hand LED in the button lights up until the rotor is stationary. Once the rotor is stationary the left-hand LED flashes in the button. Pressing the button twice triggers the EMERGENCY STOP.
- Unlock the lid.
The left-hand LED in the button goes out.
- Leave the parameter input.



- Switch between RPM and RCF display.
RCF values are displayed in > <.



- Start pre-cooling.
The pre-cooling speed is settable. It is pre-adjusted to 2800 RPM.

14.3 Adjustment possibilities

PROG RCL Program position of the called-up program.

t/min Running time. Settable from 0 - 99 min, in 1 min increments.

t/sec Running time. Settable from 0 - 59 s, in 1 second increments.

Continuous run "∞". Set parameter **t/min** and **t/sec** to zero.

RPM Revolutions per minute. A numerical value from 500 RPM up to the maximum speed of the rotor can be set. Maximum speed of the rotor, see Chapter "Anhang/Appendix, Rotoren und Zubehör/Rotors and accessories". Settable in increments of 10.

RAD/mm Centrifugation radius. Input in mm. For centrifugation radius see Chapter "Anhang/Appendix, Rotoren und Zubehör/Rotors and accessories". The input of the radius is only possible if the RCF display (> RCF <) is selected.

RCF Relative centrifugal force. A numerical value can be set, which gives a speed between 500 RPM and the maximum speed of the rotor. Adjustable up to 100 in intervals of 1, and from 100 in intervals of 10. The RCF value is automatically rounded up or rounded down with regard to the RPM interval. The input of the RCF is only possible if the RCF display (> RCF <) is selected.



Starting steps 1 - 9. Step 9 = shortest starting time, Step 1 = longest starting time.



Brake steps 0 - 9. Step 9 = shortest run-down time, Step 1 = long run-down time, Step 0 = longest run-down time (brakeless run-down).

T/°C Temperature Set Point (only in centrifuges with cooling). Adjustable from -20°C to +40°C, in 1°C intervals. The lowest obtainable temperature depends on the rotor (see Chapter "Anhang/Appendix, Rotoren und Zubehör/Rotors and accessories").

PROG STO Program position on which the program is stored. 9 programs can be stored (program positions 1 - 2 - 3 - ... 9). The programme position # serves as temporary storage for altered adjustments.

15 Entering centrifugation parameter

 If no key is pressed for 8 seconds long after the selection or during the input of parameters, the previous values will be shown in the display. The input of parameter then has to be executed again.

- Select the RPM or RCF display with the key **[RCF]**. RCF values are displayed in **> <**.
- Select the desired parameters using the button **[SELECT]** and set using the knob **○**.
In order to set continuous operation, the parameters **t/min** and **t/sec** must be set to zero with the **○** knob. Continual running is represented in the display by the following symbol, "∞".
- After input of all parameters, press the key **[START/IMPULS]** in order to store the adjustments on the programme position **#**. As confirmation, ***** ok ***** will be displayed for a short period.

 The data on the programme position **#** will be overwritten with every input of parameters and pressing of the key **[START/IMPULS]**.

16 Programming

16.1 Programme input/alteration

 If no key is pressed for 8 seconds long after the selection or during the input of parameters, the previous values will be shown in the display. The input of parameter then has to be executed again.

- Select the RPM or RCF display with the key **[RCF]**. RCF values are displayed in **> <**.
- Select the desired parameters using the button **[SELECT]** and set using the knob **○**.
In order to set continuous operation, the parameters **t/min** and **t/sec** must be set to zero with the **○** knob. Continual running is represented in the display by the following symbol, "∞".
- The parameter **PROG STO** can be selected using the button **[SELECT]** and the desired program position set using the knob **○**.
- Press the button **[START/IMPULS]** in order to store the setting on the desired program position. ***** ok ***** is displayed briefly as confirmation.
If the key **[START/IMPULS]** is pressed without the parameter **PROG STO** being activated, the settings are always stored in the program place **#**.

 The previous data in the program position is overwritten during saving.

16.2 Programme recall

- Select the parameter **PROG RCL** using the button **[SELECT]** and set the desired program position using the knob **○**.
- Press the button **[START/IMPULS]**. The centrifugation data of the selected program position is displayed.
- The parameters can be checked by pressing the button **[SELECT]**.
To leave the parameter display press the button **[OPEN/STOP]** or press no button for a period of 8 seconds.

17 Centrifugation

 When the centrifuge is running, according to EN / IEC 61010-2-020, no persons, dangerous substances or objects may be within the safety margin of 300 mm around the centrifuge.

 If the permissible weight difference within the rotor loading has been exceeded, the drive shuts down during the start-up, the unbalance display lights up, and **IMBALANCE** is displayed.

A centrifugation run can be stopped at any time by pushing the key **[OPEN/STOP]**.

All parameters can be selected and altered during the centrifugation run (see Chapter "Entering centrifugation parameter").

You can switch-over at any time between the RPM and RCF display with the key **[RCF]**. The input of the centrifugation radius is necessary if you are working with the RCF display.

If **≤ OPEN ≤ OEFFNEN** is displayed, a further operation of the centrifuge is only possible after opening the lid once.

If **R xx n-max xxxxx** is displayed, then no centrifugation run has taken place as the rotor was changed beforehand, refer to Chapter "Rotor Identification".

- Turn on the mains switch. Switch position **I**.
- Load the rotor and close the centrifuge lid.

17.1 Centrifugation with pre-set time

- Adjusting time or recall a programme with pre-set time (see Chapter "Programming").
- Press the key **(START/IMPULS)**. The LED in the button **(START/IMPULS)** lights up for as long as the rotor turns.
- After expiration of the time or with truncation of the centrifugation run by pushing the key **(OPEN/STOP)**, the run-down is effected with the selected brake step. The brake step is displayed.

During the centrifugation run the rotational speed of the rotor or the subsequently resulting RCF value, the sample temperature (only in centrifuges with cooling) and the remaining time will be displayed.

17.2 Continuous run

- Adjusting the symbol ∞ or recall a continuous run programme (see Chapter "Programming").
- Press the key **(START/IMPULS)**. The LED in the button **(START/IMPULS)** lights up for as long as the rotor turns. The time metering begins at 00:00.
- Press the key **(OPEN/STOP)** in order to stop the centrifugation run. The run-down is effected with the selected brake step. The brake step is displayed.

During the centrifugation run the rotational speed of the rotor or the subsequently resulting RCF value, the sample temperature (only in centrifuges with cooling) and the expired time will be displayed.

17.3 Short-term centrifugation

- Hold down the key **(START/IMPULS)**. The LED in the button **(START/IMPULS)** lights up for as long as the rotor turns. The time metering begins at 00:00.
- Let go of the key **(START/IMPULS)** again in order to stop the centrifugation run. The run-down is effected with the selected brake step. The brake step is displayed.

During the centrifugation run the rotational speed of the rotor or the subsequently resulting RCF value, the sample temperature (only in centrifuges with cooling) and the expired time will be displayed.

18 Emergency Stop

- Press the key **(OPEN/STOP)** twice.

With Emergency Stop the run-down is effected with brake step 9 (shortest run-down time). Brake step 9 is displayed. If brake step 0 was pre-selected, the run-down time is technically longer than with brake step 9.

19 Acoustic Signal

The acoustic signal sounds:

- Upon the appearance of a disturbance in 2 second intervals.
- After completion of a centrifugation run and rotor standstill in 30 second intervals.

The acoustic signal is stopped by opening the lid or pressing any key.

The signal after completion of the centrifugation run can be activated or deactivated in the following manner, if the rotor is at standstill:

- Hold down the key **(SELECT)** for 8 seconds.
After 8 seconds, **SOUND / BELL** appears in the display.
- Set using the knob **(OFF/ON)** **OFF** or **ON**.
- Press the key **(START/IMPULS)** in order to store the setting.
As confirmation, ***** ok ***** will be displayed for a short period.

20 Recall hours of operation

Recall hours of operation is only possible during rotor standstill.

- Hold down the key **(SELECT)** for 8 seconds.
After 8 seconds, **SOUND / BELL** appears in the display.
- Press the key **(SELECT)** once again.
The centrifuge's hours of operation (**CONTROL:**) are displayed.
- Press the key **(OPEN/STOP)** to exit the hours of operation recall.

21 Cooling (only in centrifuges with cooling)



The temperature set-point can be adjusted from -20°C to +40°C. The lowest obtainable temperature is dependent on the rotor (see Chapter "Anhang/Appendix, Rotoren und Zubehör/Rotors and accessories").

21.1 Standby-cooling

With rotor standstill and closed lid the centrifugal chamber is cooled to the pre-selected temperature. The temperature set-point is shown in the display.



Standby cooling will be subject to a timed delay after a centrifuge run and the display will show **OPEN** **OEFFNEN**. The delay time can be pre-set in 1 minute steps from 1 to 5 minutes. It is pre-set to 1 minute.

With the rotor standing still and the cover open the delay time can be set as follows:

- Hold down the key  for 8 seconds.
After 8 seconds, **t/min = X** appears in the display.
- Use the rotary button  to set the delay time.
- Press the key  in order to store the setting.
As confirmation, ***** ok ***** will be displayed for a short period.

To leave the delay time display press the key  or do not press any key for a period of 8 seconds.





21.2 Pre-cooling the rotor

- Press the key . The LED in the button  lights up for as long as the rotor turns.
- Press the button  to end the pre-cooling. The run-down is effected with the selected brake step. The brake step is displayed.

During the centrifugation run the rotational speed of the rotor or the subsequently resulting RCF value, the sample temperature and the expired time will be displayed.

The pre-cooling speed can be adjusted in decadic steps from 500 RPM to the max RPM of the rotor. It is pre-adjusted to 2800 RPM.

When the rotor is stationary and the lid open the pre-cooling speed can be set in the following manner:

- Hold down the key  for 8 seconds.
After 8 seconds, **t/min = X** appears in the display.
- Press the key  once again.
The set pre-cooling RPM - **RPM = XXXX** will be displayed.
- Set the desired pre-cooling speed using the knob .
- Press the key  in order to store the setting.
As confirmation, ***** ok ***** will be displayed for a short period.

To leave the pre-cooling RPM display press the key  or do not press any key for a period of 8 seconds.

22 Relative centrifugal force (RCF)

The relative centrifugal force (RCF) is given as a multiple of the acceleration of gravity (g). It is a unit-free value and serves to compare the separation and sedimentation performance.

These values are calculated using the formula below:

$$\text{RCF} = \left(\frac{\text{RPM}}{1000} \right)^2 \times r \times 1,118 \quad \Rightarrow \quad \text{RPM} = \sqrt{\frac{\text{RCF}}{r \times 1,118}} \times 1000$$

RCF = relative centrifugal force

RPM = rotational speed (revolutions per minute)

r = centrifugal radius in mm = distance from the centre of the turning axis to the bottom of the centrifuge container. For more on the centrifugal radius see the chapter "Anhang/Appendix, Rotoren und Zubehör/Rotors and accessories".



The relative centrifugal force (RCF) stands in relation to the revolutions per minute and the centrifugal radius.

23 Centrifugation of materials or mixtures of materials with a density higher than 1.2 kg/dm³

When centrifuging with maximum revolutions per minute the density of the materials or the material mixtures may not exceed 1.2 kg/dm³.

The speed must be reduced for materials or mixtures of materials with a higher density.

The permissible speed can be calculated using the following formula:

$$\text{Reduced speed } (n_{\text{red}}) = \sqrt{\frac{1.2}{\text{Greater density [kg/dm}^3]}} \times \text{maximum speed [RPM]}$$

e.g.: maximum speed RPM 4000, density 1.6 kg/dm³

$$n_{\text{red}} = \sqrt{\frac{1.2 \text{ kg/dm}^3}{1.6 \text{ kg/dm}^3}} \times 4000 \text{ RPM} = 3464 \text{ RPM}$$

In the exceptional case that the maximum loading indicated on the hanger is exceeded, the speed must also be reduced.

The permissible speed can be calculated using the following formula:

$$\text{Reduced speed } (n_{\text{red}}) = \sqrt{\frac{\text{maximum load [g]}}{\text{actual load [g]}}} \times \text{maximum speed [RPM]}$$

e.g.: maximum speed RPM 4000, maximum load 300 g, actual load 350 g

$$n_{\text{red}} = \sqrt{\frac{300 \text{ g}}{350 \text{ g}}} \times 4000 \text{ RPM} = 3703 \text{ RPM}$$

If in doubt you should obtain clarification from the manufacturer.

24 Rotor recognition

Rotor recognition is carried out after each start of the centrifugation run.

If the rotor has been changed, the centrifugation run is canceled after rotor recognition. The rotor code (R xx) and the maximum speed (n-max=xxxxx) of the rotor are displayed.



A further operation of the centrifuge is only possible after a single opening of the lid.

If the maximum speed of the rotor being used is less than the set speed, the speed is limited to the rotor's maximum speed.

25 Emergency release

During a power failure the lid cannot be unlocked by motor. An emergency release has to be executed by hand.



For emergency release disconnect the centrifuge from the mains.
Open the lid only during rotor standstill.

See figure on page 2.

- Switch off the mains switch (switch position "0").
- Look through the window in the lid to be sure that the rotor has come to a standstill.
- Insert the hexagonal wrench key into the bore hole (Fig. 1, A) and carefully rotate by half a turn in clockwise direction until the lid can be opened.
- Pull the hexagon socket head wrench out of the drilling again.
- If the left LED in the **OPEN / STOP** button flashes after the centrifuge is switched on again, press the **OPEN / STOP** button so that the motor-driven lid lock goes into the basic position (opened) again.

26 Maintenance and servicing



The device can be contaminated.



Pull the mains plug before cleaning.

Before any other cleaning or decontamination process other than that recommended by the manufacturer is applied, the user has to check with the manufacturer that the planned process does not damage the device.

- Centrifuges, rotors and accessories must not be cleaned in rinsing machines.
- They may only be cleaned by hand and disinfected with liquids.
- The water temperature must be between 20 – 25°C.
- Only detergents/disinfectants may be used which:
 - have a pH between 5 - 8
 - do not contain caustic alkalis, peroxides, chlorine compounds, acids and alkaline solutions
- In order to prevent appearances of corrosion through cleaning agents or disinfectants, the application guide from the manufacturer of the cleaning agent or disinfectant are absolutely to be heeded.

26.1 Centrifuge (housing, lid and centrifuging chamber)

26.1.1 Surface cleaning and care

- Clean the centrifuge housing and the centrifuging chamber regularly, using soap or a mild detergent and a damp cloth if required. For one thing, this services purposes of hygiene, and it also prevents corrosion through adhering impurities.
- Ingredients of suitable detergents: soap, anionic tensides, non-ionic tensides.
- After using detergents, remove the detergent residue by wiping with a damp cloth.
- The surfaces must be dried immediately after cleaning.
- In the event of condensation water formation, dry the centrifugal chamber by wiping out with an absorbent cloth.
- Lightly rub the rubber seal of the centrifuge chamber with talcum powder or a rubber care product after each cleaning.
- The centrifuging chamber is to be checked for damage once a year.



If damage is found which is relevant to safety, the centrifuge may no longer be put into operation. In this case, notify Customer Service.

26.1.2 Surface disinfection

- If infectious materials penetrates into the centrifugal chamber this is to be disinfected immediately.
- Ingredients of suitable disinfectants: ethanol, n-propanol, ethyl hexanol, anionic tensides, corrosion inhibitors.
- After using disinfectants, remove the disinfectant residue by wiping with a damp cloth.
- The surfaces must be dried immediately after disinfecting.

26.1.3 Removal of radioactive contaminants

- The agent must be specifically labelled as being an agent for removing radioactive contaminants.
- Ingredients of suitable agents for removing radioactive contaminants: anionic tensides, non-ionic tensides, polyhydrated ethanol.
- After removing the radioactive contaminants, remove the agent residue by wiping with a damp cloth.
- The surfaces must be dried directly after removing the radioactive contaminants.

26.2 Rotors and Attachments

26.2.1 Cleaning and care

- In order to avoid corrosion and changes in materials, the rotors and accessories have to be cleaned regularly with soap or with a mild cleaning agent and a moist cloth. Cleaning is recommended at least once a week. Contaminants must be removed immediately.
- Ingredients of suitable detergents:
soap, anionic tensides, non-ionic tensides.
- After using detergents, remove detergent residue by rinsing with water (only outside of the centrifuge) or wipe off with a damp cloth.
- The rotors and accessories must be dried directly after cleaning.
- Angle rotors, container and hanger made of aluminium are to be lightly greased after drying using acid-free grease, e.g. vaseline.
- The sealing rings of bio-safety systems must be cleaned weekly.
The sealing rings are made of silicone. To guarantee the leak-tightness of the bio-safety systems, the sealing rings must not be handled with talcum powder after cleaning or autoclaving.
Each time before using the bio-safety system, all parts of the bio-safety system must be visually inspected for damage. In addition, the sealing ring(s) of the bio-safety system must be checked to make sure they are in the correct installation position.
Damaged parts of the bio-safety system must be exchanged immediately.
If there are signs of crack formation, brittleness or wear, immediately replace the sealing ring in question. In the case of lids with sealing rings which cannot be replaced, the entire lid must be exchanged.
For the available bio-safety systems, see the chapter "Appendix, Rotors and accessories".
- In order to prevent corrosion as a result of moisture between the rotor and the motor shaft, the rotor should be disassembled and cleaned at least once a month, and the motor shaft should be lightly greased.
- The rotors and accessories have to be checked weekly for wear and corrosion. For swing-out rotors, it is important to check the area of the lifting lugs, for hangers, the grooves and the base should be checked for cracks.

Example: Crack in the groove area:

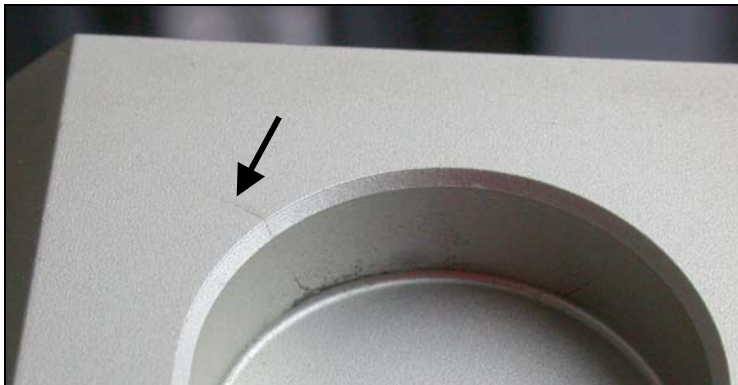

Rotors and attachments may no longer be utilised upon indication of wear and tear or corrosion.

- Check the firm seating of the rotor on a weekly basis.

26.2.2 Disinfection

- If infectious material should get on the rotors or accessories, they must be appropriately disinfected.
- Ingredients of suitable disinfectants:
ethanol, n-propanol, ethyl hexanol, anionic tensides, corrosion inhibitors.
- After using disinfectants, remove disinfectant residue by rinsing with water (only outside of the centrifuge) or wipe off with a damp cloth.
- The rotors and accessories must be dried directly after disinfection.

26.2.3 Removal of radioactive contaminants

- The agent must be specifically labelled as being an agent for the removal of radioactive contaminants.
- Ingredients of suitable agents for removing radioactive contaminants:
anionic tensides, non-ionic tensides, polyhydrated ethanol.
- After removing the radioactive contaminants, remove agent residue by rinsing with water (only outside of the centrifuge) or wipe off with a damp cloth.
- The rotors and accessories must be dried directly after removing the radioactive contaminants.

26.2.4 Trunnions

With swing-out rotors the trunnions must be regularly lubricated (Hettich Lubricating Grease No. 4051) in order to ensure consistent swinging out of the hangers.

26.2.5 Rotors and accessories with limited service lives

The use of certain rotors, hangers and accessory parts is limited by time.

These are marked with the maximum permitted number of operating cycles or with an expiration date and the maximum permitted number of operating cycles or just with the expiration date; e.g.:

- "einsetzbar bis Ende: IV. Quartal 2011 / usable until end of: IV. Quarter 2011" or
- "einsetzbar bis Ende Monat/Jahr: 10/2011 / usable until end of month/year: 10/2011"
- "Max. Lauf Zyklen / max. cycles: 40000".



For safety reasons, rotors, hangers and accessory parts may no longer be used if either the indicated maximum number of operating cycles or the indicated expiration date has been reached.

26.3 Autoclaving

The following accessories may be autoclaved at 121°C / 250°F (20 min):

- Swing-out rotors
- Angle rotors made of aluminium
- Hangers made of metal
- Lid with bio-seal
- Adapter

Nothing definitive can be said about the degree of sterility.



The lids of the rotors and containers must be removed before autoclaving.

Autoclaving accelerates the ageing process of plastics. In addition, it can cause discolourations in plastics.

The lid of the rotors 1515 and 1515-A may only be autoclaved 10x. Afterwards, it must be exchanged for safety reasons.

After autoclaving, the rotors and the accessories must be visually inspected for damage and any damaged parts must be exchanged immediately.

If there are signs of crack formation, brittleness or wear, immediately replace the sealing ring in question.

In the case of lids with sealing rings which cannot be replaced, the entire lid must be exchanged.

To guarantee the leak-tightness of the bio-safety systems, the sealing rings must not be handled with talcum powder after autoclaving.

26.4 Centrifuge containers

- With leakiness or after the breakage of centrifuging containers broken container parts, glass splinters and leaked centrifugation material are to be completely removed.
- The rubber inserts as well as the plastic sleeves of the rotors are to be replaced after a glass breakage.



Remaining glass splinters cause further glass breakage!

- If this concerns infectious material, a disinfection process is to be executed immediately.

27 Faults

If the fault cannot be eliminated with the help of the fault table, please inform Customer Service.

Please specify the type of centrifuge and the serial number. Both numbers can be found on the name plate of the centrifuge.



Perform a MAINS RESET:

- Switch off the mains switch (switch position "0").
- Wait at least 10 seconds and then switch on the mains switch again (switch position "I").

Message / fault		Cause	Remedy
No display	---	No voltage. Overvoltage protection tripped out.	<ul style="list-style-type: none"> - Check supply voltage. - Mains switch ON.
TACHO - ERROR	1, 2, 96	Faulty speedometer. Motor, electronics defective.	<ul style="list-style-type: none"> - Open the cover. - Switch off the mains switch (switch position "0"). - Wait at least 10 seconds. - Turn the rotor vigorously by hand. - Switch on the mains switch again (switch position "I"). The rotor must turn during switch-on.
CONTROL - ERROR	8	Error in lid locking or lid closure.	<ul style="list-style-type: none"> - Open lid. - Check the loading of the rotor, see chapter "Loading the rotor". - Repeat the centrifugation run.
IMBALANCE	---	The rotor is unevenly loaded.	<ul style="list-style-type: none"> - Open lid. - Check the loading of the rotor, see chapter "Loading the rotor". - Repeat the centrifugation run.
CONTROL - ERROR	4, 6	Error in lid locking or lid closure.	<ul style="list-style-type: none"> - Perform a MAINS RESET.
N > MAX	5	Rotation too fast	
N < MIN	13	Rotation too slow	
MAINS INTERRUPT	---	Power failure during the centrifugation run. (The centrifugation run was not finished.)	<ul style="list-style-type: none"> - Open lid. - Push START / IMPULS button. - Repeat the centrifugation run if necessary.
ROTORCODE	10.1, 10.2	Incorrect rotor coding	<ul style="list-style-type: none"> - Open lid.
CONTROL-ERROR	21, 22, 25, 27, 29	Error / defect electronics	<ul style="list-style-type: none"> - Perform a MAINS RESET.
CONTROL-ERROR	23	Error / defect controls	
SER I/O - ERROR	30, 31, 33, 36	Error / defect electronics	
° C * - ERROR	51 - 53, 55	Error / defect electronics	
FU / CCI - ERROR	60 - 64, 67, 68, 82 - 86	Error / defect electronics / motor	
SYNC-ERROR	90	Error / defect electronics	
SENSOR-ERROR	91 - 93	Error / defect unbalance sensor	
KEYBOARD-ERROR	---	Error / defect controls	
NO ROTOR	---	No rotor installed	<ul style="list-style-type: none"> - Open lid. - Install rotor.
N > ROTOR MAX	---	Speed in the selected program greater than the maximum speed of the rotor. The rotor has been changed. The maximum speed of the installed rotor is higher than that of the rotor that was previously used and this has not yet been detected by rotor recognition.	<ul style="list-style-type: none"> - Check the set speed. Reduce the set speed - Set a speed up to the maximum speed of the rotor that was previously used. Press the START / IMPULS key to run rotor recognition. See chapter, "Rotor Recognition".

28 Returning Devices



Before returning the device, a transport securing device has to be installed.

If the device or its accessories are returned to Andreas Hettich GmbH & Co. KG, in order to provide protection for people, the environment and materials, it has to be decontaminated and cleaned before being shipped.

We reserve the right to refuse contaminated devices or accessories.

Costs incurred for cleaning and disinfection are to be charged to the customer.

We ask for your understanding in this matter.

29 Disposal

Before disposal, the device must be decontaminated and cleaned to protect people, the environment and property.

When you are disposing of the device, the respective statutory rules must be observed.

Pursuant to guideline 2002/96/EC (WEEE), all devices supplied after August 13, 2005 may not be disposed as part of domestic waste. The device belongs to group 8 (medical devices) and is categorized in the business-to-business field.



The icon of the crossed-out trash can shows that the device may not be disposed as part of domestic waste.

The waste disposal guidelines of the individual EC countries might vary. If necessary, contact your supplier.

Table des matières

1	Usage conforme	59
2	Risques résiduels	59
3	Données techniques	59
4	Consignes de sécurité	62
5	Signification des symboles.....	64
6	Composition de la livraison	64
7	Déballer la centrifugeuse	64
8	Mise en service.....	65
9	Ouvrir et fermer le couvercle.....	65
9.1	Ouvrir le couvercle.....	65
9.2	Fermer le couvercle.....	65
10	Montage et démontage du rotor	66
10.1	Rotor avec écrou.....	66
10.2	Rotor sans écrou.....	66
10.2.1	Montage et démontage du moyeu	66
10.2.2	Insérer et retirer le rotor	66
11	Chargement du rotor	67
12	Poser dans le balancier l'adaptateur avec tenon de positionnement.....	68
13	Manipuler des systèmes de biosécurité	68
13.1	Fermer et ouvrir les couvercles de systèmes de biosécurité.....	68
13.1.1	Couvercle à fermeture vissée et alésage dans la poignée tournante.....	68
13.1.2	Couvercle avec fermeture à vis.....	69
13.1.3	Couvercle avec bride et fermeture par grenouillère	69
13.2	Stockage de systèmes de biosécurité.....	70
14	Organes de commande et indicateurs.....	70
14.1	Bouton de réglage.....	70
14.2	Touches de la console de commande.....	70
14.3	Possibilités de réglage	71
15	Saisie des paramètres de centrifugation	72
16	Programmation.....	72
16.1	Saisie / Modification de programme.....	72
16.2	Appel de programme.....	72
17	Centrifugation	73
17.1	Centrifugation avec sélection de temps préalable.....	73
17.2	Centrifugation continue	73
17.3	Centrifugation rapide.....	73
18	Arrêt d'urgence	73
19	Signal sonore	74
20	Interrogation du compteur de durée de fonctionnement.....	74
21	Refroidissement (uniquement sur centrifugeuse avec refroidissement).....	74
21.1	Refroidissement en veilleuse	74
21.2	Pré-refroidissement du rotor	74
22	Accélération centrifuge relative (RCF).....	75

23	Centrifugation de matières et de mélanges d'une densité supérieure à 1,2 kg/dm ³	75
24	Identification du rotor	75
25	Déverrouillage d'urgence	76
26	Entretien et maintenance	76
26.1	Centrifugeuse (boîtier, couvercle et cuve)	76
26.1.1	Entretien et nettoyage des surfaces	76
26.1.2	Désinfection des surfaces	76
26.1.3	Décontamination de substances radioactives	77
26.2	Rotors et accessoires	77
26.2.1	Nettoyage et entretien	77
26.2.2	Désinfection	78
26.2.3	Décontamination de substances radioactives	78
26.2.4	Goupilles de fixation	78
26.2.5	Rotors et accessoires à durée d'utilisation limitée	78
26.3	Autoclave	79
26.4	Réservoirs de centrifugation	79
27	Défauts	80
28	Renvoi d'appareils au fabricant	81
29	Élimination des déchets	81
30	Anhang / Appendix	106
30.1	Rotoren und Zubehör / Rotors and accessories	106

1 Usage conforme

L'appareil dont il est question est un produit médical (centrifugeuse de laboratoire) dans l'esprit de la directive IVD 98/79/CE.

La centrifugeuse sert à la séparation de substances ou mélanges de substances d'une densité maximum de 1,2 kg/dm³. Ce qui comprend, en particulier, tout prélèvement destiné à la préparation de diagnostics In-vitro dans le cadre de la médecine humaine.

La centrifugeuse est exclusivement destinée à cette plage d'utilisation.

Toute utilisation en dehors ou au delà de ce cadre est considérée comme non conforme. L'entreprise Andreas Hettich GmbH & Co. KG décline toute responsabilité pour tout dommage en résultant.

L'utilisation conforme comprend également le respect de toutes les indications contenues dans le mode d'emploi et des travaux d'inspection et d'entretien.

2 Risques résiduels

L'appareil est construit conformément au niveau actuel de la technologie et des règles de sécurité éprouvées. L'utilisation et la manipulation non conforme de cet appareil risquent de menacer la santé et l'intégrité corporelle de l'utilisateur ou de tierces personnes, ou de détériorer l'appareil ou autres biens matériels. Utilisez exclusivement l'appareil conformément à l'usage pour lequel il a été conçu et uniquement s'il est dans un état de fonctionnement technique irréprochable.

Remédier sans attendre à tout dérangement susceptible de porter atteinte à la sécurité.

3 Données techniques

Fabricant	Andreas Hettich GmbH & Co. KG D-78532 Tuttlingen				
Modèle	UNIVERSAL 320		UNIVERSAL 320 R		
Type	1401	1401-01	1406	1406-01	
Tension du réseau ($\pm 10\%$)	200-240 V 1~	100-127 V 1~	200-240 V 1~	240 V 1~	115-127 V 1~
Fréquence du réseau	50 – 60 Hz	50 – 60 Hz	50 Hz	60 Hz	60 Hz
Charge de connexion	400 VA	400 VA	800 VA		950 VA
Consommation de courant	2.0 A	4.0 A	4.0 A		8.0 A
Réfrigérant	----		R 404A		
Capacité max.	4 x 200 ml				
Densité admise	1.2 kg/dm ³				
Vitesse de rotation (RPM)	16000				
Accélération (RCF)	24900				
Energie cinétique	9500 Nm				
Obligation de contrôle (DGUV Regel 100 - 500)	non				
Conditions ambiantes (EN / IEC 61010-1)	uniquement dans les intérieurs				
– Emplacement	Jusqu'à 2000 m au dessus du niveau de la mer				
– Hauteur	2°C à 35°C				
– Température ambiante	5°C à 35°C				
– Humidité de l'air	humidité de l'air max. relative 80% pour températures jusqu'à 31°C, décroissant en linéaire jusqu'à 50% de l'humidité relative pour 40°C.				
– Catégorie de surtension (IEC 60364-4-443)	II				
– Degré d'encrassement	2				
Catégorie de protection de l'appareil	I				
Non approprié pour l'usage dans un environnement exposé aux explosions.					
EMV	EN / IEC 61326-1, catégorie B		FCC Class B		
– Emission de parasites, Résistance aux interférences	EN / IEC 61326-1, catégorie B		EN / IEC 61326-1, catégorie B		
Niveau du bruit (en fonction du rotor)	≤ 68 dB(A)		≤ 64 dB(A)		
Dimensions					
– Largeur	401 mm		407 mm		
– Profondeur	529 mm		698 mm		
– Hauteur	346 mm		346 mm		
Poids	env. 31 kg		env. 52 kg		

Fabricant	Andreas Hettich GmbH & Co. KG D-78532 Tuttlingen			
Modèle	UNIVERSAL 320 R			
Type	1406-50	1406-51	1406-70	1406-71
Tension du réseau ($\pm 10\%$)	200-240 V 1~	100-127 V 1~	200-240 V 1~	100-127 V 1~
Fréquence du réseau	50 – 60 Hz	50 – 60 Hz	50 – 60 Hz	50 – 60 Hz
Charge de connexion	400 VA	400 VA	400 VA	400 VA
Consommation de courant	2.0 A	4.0 A	2.0 A	4.0 A
Capacité max.	4 x 200 ml			
Densité admise	1.2 kg/dm ³			
Vitesse de rotation (RPM)	16000			
Accélération (RCF)	24900			
Energie cinétique	9500 Nm			
Obligation de contrôle (DGUV Regel 100 - 500)	non			
Conditions ambiantes (EN / IEC 61010-1)	uniquement dans les intérieurs Jusqu'à 2000 m au dessus du niveau de la mer 2°C à 35°C humidité de l'air max. relative 80% pour températures jusqu'à 31°C, décroissant en linéaire jusqu'à 50% de l'humidité relative pour 40°C.			
– Emplacement				
– Hauteur				
– Température ambiante				
– Humidité de l'air				
– Catégorie de surtension (IEC 60364-4-443)	II			
– Degré d'encrassement	2			
Catégorie de protection de l'appareil	I			
Non approprié pour l'usage dans un environnement exposé aux explosions.				
EMV				
– Emission de parasites, Résistance aux interférences	EN / IEC 61326-1, catégorie B	FCC Class B	EN / IEC 61326-1, catégorie B	FCC Class B
Niveau du bruit (en fonction du rotor)	≤ 64 dB(A)			
Dimensions				
– Largeur	401 mm		401 mm	
– Profondeur	549 mm		550 mm	
– Hauteur	346 mm		365 mm	
Poids	env. 35 kg			

Fabricant	Andreas Hettich GmbH & Co. KG D-78532 Tuttlingen		
Modèle	UNIVERSAL 320 R		
Type	1406-20		1406-21
Tension du réseau ($\pm 10\%$)	200-240 V 1~	240 V 1~	115-127 V 1~
Fréquence du réseau	50 Hz	60 Hz	60 Hz
Charge de connexion	800 VA		950VA
Consommation de courant	4.0 A		8.0 A
Réfrigérant	R 404A		
Capacité max.	4 x 200 ml		
Densité admise	1.2 kg/dm ³		
Vitesse de rotation (RPM)	16000		
Accélération (RCF)	24900		
Energie cinétique	9500 Nm		
Obligation de contrôle (DGUV Regel 100 - 500)	non		
Conditions ambiantes (EN / IEC 61010-1)	<p>uniquement dans les intérieurs Jusqu'à 2000 m au dessus du niveau de la mer 5°C à 35°C humidité de l'air max. relative 80% pour températures jusqu'à 31°C, décroissant en linéaire jusqu'à 50% de l'humidité relative pour 40°C.</p>		
– Emplacement			
– Hauteur			
– Température ambiante			
– Humidité de l'air			
– Catégorie de surtension (IEC 60364-4-443)	II		
– Degré d'encrassement	2		
Catégorie de protection de l'appareil	I		
Non approprié pour l'usage dans un environnement exposé aux explosions.			
EMV			
– Emission de parasites, Résistance aux interférences	EN / IEC 61326-1, catégorie B		FCC Class B
Niveau du bruit (en fonction du rotor)	≤ 64 dB(A)		
Dimensions			
– Largeur	407 mm		
– Profondeur	725 mm		
– Hauteur	365 mm		
Poids	env. 52 kg		

4 Consignes de sécurité



Aucune demande garantie ne pourra être revendiquée auprès du fabricant si les indications données dans ce mode d'emploi ne sont pas toutes respectées.



- Veiller à la stabilité de la centrifugeuse.
- Avant d'utiliser la centrifugeuse, il est indispensable de vérifier la fixation correcte du rotor.
- Durant un processus de centrifugation, aucune personne, matière dangereuse et aucun objet ne doivent se trouver dans une zone de sécurité de 300 mm autour de la centrifugeuse selon EN / IEC 61010-2-020.
- Les rotors, balanciers et accessoires qui présentent d'importantes traces de corrosion ou des défauts mécaniques ou dont la durée d'utilisation a expiré ne doivent plus être utilisés.
- Suspender immédiatement l'utilisation de la centrifugeuse si la cuve de centrifugeuse présente des dommages susceptibles de porter atteinte à la sécurité.
- Les goupilles de fixation des rotors à amortissement doivent être graissées régulièrement (graisse de lubrification Hettich n° 4051) de manière à assurer le balancement régulier de la suspension.
- Concernant les centrifugeuses sans réglage de température, il peut y avoir un réchauffement dans la cuve de centrifugeuse en cas de température ambiante élevée et/ou d'utilisation fréquente de l'appareil. Il n'est donc pas possible d'exclure une modification de l'échantillon due à la température.

- Il importe de lire et de respecter le mode d'emploi avant la mise en service de la centrifugeuse. Seules les personnes ayant lu et compris le mode d'emploi sont autorisées à manipuler l'appareil.
- Outre le mode d'emploi et les réglementations contraignantes relatives à la prévention des accidents, il importe également de respecter les règles spécifiques et communément admises en matière de sécurité et de travail. Le mode d'emploi doit être complété des dispositions nationales applicables à la prévention des accidents et à la protection de l'environnement.
- La centrifugeuse a été construite conformément à l'état actuel de la technique et son fonctionnement est sûr. Elle peut cependant présenter des dangers pour l'utilisateur ou des tiers si son utilisation n'est pas confiée à un personnel dûment formé, est inadéquate ou non conforme à sa destination.
- Pendant le fonctionnement, la centrifugeuse ne devra pas être déplacée ou être heurtée.
- En cas de défaillance ou en cas de déverrouillage d'urgence, ne jamais intervenir dans l'appareil lorsque le rotor tourne.
- Afin d'éviter les dommages causés par la condensation en passant d'un local froid à un local chaud, il faut soit réchauffer la centrifugeuse en la laissant pendant au moins 3 heures dans le local chaud avant de la raccorder au secteur, soit la faire fonctionner pendant 30 minutes dans le local froid pour la chauffer.
- Pour cet appareil, vous ne devez utiliser que des rotors et des accessoires homologués par le fabricant (voir chapitre "Anhang/Appendix, Rotoren und Zubehör/Rotors and accessories"). Avant d'utiliser des récipients de centrifugation qui ne sont pas présentés dans le chapitre "Annexe/Appendix, rotors et accessoire/Rotors and accessories", l'utilisateur doit s'assurer auprès du fabricant qu'il peut les utiliser.
- Le rotor de la centrifugeuse doit uniquement être chargé conformément au chapitre "Chargement du rotor".
- Dans le cas de la centrifugation à la vitesse maximale, la densité des substances et des mélanges de substances ne doit pas excéder 1,2 kg/dm³.
- Il est interdit de procéder à des centrifugations en présence de défauts d'équilibrage.
- La centrifugeuse ne doit pas être exploitée dans un environnement explosif.
- Il est interdit de procéder à des centrifugations :
 - avec des matières inflammables ou explosives,
 - avec des matières susceptibles de réagir chimiquement ou de dégager d'importantes quantités d'énergie.

- L'utilisateur est tenu de prendre des mesures appropriées lors de la centrifugation de substances, ou mélanges de substances, dangereuses qui sont contaminées de manière toxique, radioactive ou par des microorganismes pathogènes.
De manière générale, utiliser des réservoirs de centrifugation avec fermeture à vis spéciales pour substances dangereuses. Concernant les matériaux du groupe à risque 3 et 4, utilisez, en plus des réservoirs de centrifugation verrouillables, un système de biosécurité (voir manuel "Laboratory Bio-safety Manual" de l'Organisation Mondiale de la Santé).
Dans un système de biosécurité, une bio-étanchéité (bague d'étanchéité) empêche les fuites de gouttes et d'aérosols.
Si vous employez le balancier d'un système de biosécurité sans le couvercle, il faut retirer la bague d'étanchéité du balancier afin d'éviter que la bague d'étanchéité soit endommagée pendant le cycle de centrifugation.
Tout système de biosécurité défectueux n'est plus étanche du point de vue microbiologique.
Une centrifugeuse utilisée sans système de biosécurité n'est plus étanche du point de vue microbiologique dans l'esprit de la norme NE / IEC 61010-2-020.
Veuillez suivre les instructions au chapitre "Manipuler des systèmes de biosécurité" lorsque vous fermez un système de biosécurité.
Vous trouverez au chapitre "Annexe/Appendix, rotors et accessoires/Rotors and accessories" la liste des systèmes de biosécurité pouvant être livrés. En cas de doute, veuillez vous renseigner auprès du fabricant.
- Il est interdit de centrifuger des matières fortement corrosives pouvant réduire la résistance mécanique des rotors, des supports et des accessoires.
- Les réparations ne peuvent être effectuées que par une personne autorisée à cet effet par le fabricant.
- Utiliser uniquement les pièces de rechange originales et les accessoires d'origine homologués par les Etablissements Andreas Hettich GmbH & Co. KG.
- Les dispositions de sécurité suivantes font foi :
EN / IEC 61010-1 et EN / IEC 61010-2-020 ainsi que les dérogations nationales.
- La sécurité et la fiabilité de la centrifugeuse seront uniquement garanties si :
 - la centrifugeuse est utilisée conformément aux instructions du mode d'emploi,
 - l'installation électrique du site de la centrifugeuse est conforme aux prescriptions EN / IEC,
 - les contrôles prescrits dans les différents pays en matière de sécurité de l'appareil, par ex. en Allemagne selon l'Assurance accidents légale allemande (DGUV) règlement 3, sont effectués par un professionnel.

5 Signification des symboles



Symbole sur l'appareil :

Attention, zone de danger général.

Avant utilisation de l'appareil, il est indispensable de lire le mode d'emploi et de respecter les consignes relatives à la sécurité!



Symbole dans ce document:

Attention, zone de danger général.

Ce symbole indique des consignes de sécurité et signale des situations pouvant être sources de danger.

Le non-respect de ces instructions peut entraîner des dégâts matériels et personnels.



Symbole sur l'appareil et dans ce document:

Avertissement de menace biologique pour l'environnement.



Symbole dans ce document:

Ce symbole signale des informations importantes.



Symbole sur l'appareil et dans ce document:

Symbole pour la collecte séparée des appareils électriques et électroniques, conformément à la directive 2002/96(EG (WEEE). L'appareil fait partie du groupe 8 (appareils de médecine).

Utilisation dans les pays de l'Union Européenne ainsi qu'en Norvège et en Suisse.

6 Composition de la livraison

- 1 Câble de connexion
- 1 Clé hexagonale
- 1 Graisse pour tourillon porteur
- 1 Mode d'emploi
- 1 Fiche de consignes pour le transport

Le(s) rotor(s) et accessoires correspondant sont livrés selon les spécifications de la commande.

7 Déballer la centrifugeuse

- Soulever le carton et retirer le matériau d'amortissement.

-



Ne pas saisir sur le tableau de commande frontal pour soulever.

Tenir compte du poids de la centrifugeuse, voir au chapitre "Données techniques".

Avec un nombre suffisant d'aides, soulever la centrifugeuse sur les deux faces et la déposer sur la table de laboratoire.

8 Mise en service

- Retirer du fond du carter les dispositifs de sécurité pour le transport, voir pour cela la fiche de données "Dispositifs de sécurité pour le transport".
- Placer la centrifugeuse sur un emplacement approprié de manière à ce qu'elle soit stable et mettre de niveau. Lors de la mise en place, il faut respecter la zone **de sécurité exigée de 300mm autour de la centrifugeuse selon EN / IEC 61010-2-020**.



Durant un processus de centrifugation, aucune personne, matière dangereuse et aucun objet ne doivent se trouver dans une zone de sécurité de 300 mm autour de la centrifugeuse selon EN / IEC 61010-2-020.

- Ne pas recouvrir les fentes d'aération. Veuillez respecter un écart de 300 mm jusqu'aux fentes et ouvertures d'aération de la centrifugeuse.
- Pour la centrifugeuse de type 1406-20, 1406-21, raccorder l'alimentation en azote selon la fiche de consignes jointe AH1406-20XX.
Pour la centrifugeuse de type 1406-50, 1406-51, raccorder le système pour chauffer/réfrigérer selon la fiche de consignes jointe AH1406-50XX.
Pour la centrifugeuse de type 1406-70, 1406-71, raccorder le système pour chauffer/réfrigérer et l'alimentation en azote selon la fiche de consignes jointe AH1406-70XX.



Le raccord de la centrifugeuse doit absolument être effectué conformément à la fiche de consignes jointe.
Observer impérativement la feuille de consignes jointe.

- Vérifier que la tension de secteur est identique à la mention de la plaque signalétique.
- Brancher la centrifugeuse avec son cordon de raccordement sur une prise secteur aux normes. Puissance connectée voir chapitre "Données techniques".
- Activer l'interrupteur de secteur. Amener l'interrupteur en position "1".
Le type de la machine et la version du programme s'affichent, les diodes s'allument. Après 8 secondes, **OPEN** / **OEFFNEN** s'affiche et la DEL gauche dans la touche **STOP/OPEN** clignote.
- Ouvrir le capot.
Les dernières données de centrifuge utilisées s'affichent.

9 Ouvrir et fermer le couvercle

9.1 Ouvrir le couvercle



Le capot ne peut être ouvert que lorsque la centrifugeuse est sous tension et que le rotor est à l'arrêt. Dans les autres cas, voir le chapitre, "Déverrouillage d'urgence".

- Appuyer sur la touche **OPEN/STOP**. Le couvercle est déverrouillé par le moteur et la DEL gauche située dans la touche **OPEN/STOP** s'éteint.

9.2 Fermer le couvercle



Ne pas mettre les doigts entre le couvercle et le boîtier.
Ne pas laisser tomber le couvercle pour le fermer.

Lorsque la DEL gauche de la touche **OPEN/STOP** clignote, appuyer la touche **OPEN/STOP** pour amener le verrouillage motorisé du couvercle en position de base (ouvert).

- Mettre le couvercle en place et appuyer légèrement sur la bordure avant du couvercle. Le verrouillage est automatique. La DEL de gauche intégrée dans la touche **OPEN/STOP** s'allume.

10 Montage et démontage du rotor

10.1 Rotor avec écrou

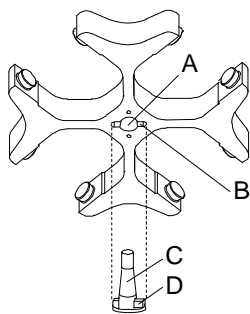

Montage du rotor :

 La présence d'impuretés entre l'arbre moteur et le rotor empêche au rotor d'avoir une position parfaite, et provoque un fonctionnement irrégulier du rotor.

- Nettoyer l'arbre moteur (C) et l'ouverture du rotor (A), graisser ensuite légèrement l'arbre moteur.
- Placer le rotor à la verticale sur l'arbre moteur. L'entraîneur de l'arbre moteur (D) doit se trouver dans la rainure du rotor (B). La direction de la rainure est indiquée sur le rotor.
- Serrer l'écrou du rotor à l'aide de la clé fournie, en tournant dans le sens des aiguilles d'une montre.
- Vérifier si le rotor se trouve dans une position fixe.

Démontage du rotor :

- Desserrer l'écrou en tournant dans le sens inverse des aiguilles d'une montre, et tourner jusqu'au point de pression pour le retrait. Après avoir franchi ce point de pression, le rotor se détache du cône de l'arbre moteur.
- Tourner l'écrou jusqu'à pouvoir soulever le rotor de l'arbre moteur.

10.2 Rotor sans écrou

10.2.1 Montage et démontage du moyeu

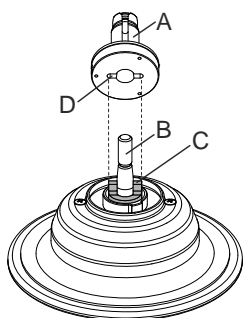

Montage du moyeu :

- Poser le moyeu (A) sur l'arbre moteur (B) à la verticale. L'entraîneur (C) sur l'arbre moteur doit se trouver dans la rainure (D) du moyeu.
- Avec la clé hexagonale fournie, serrer l'écrou du moyeu en tournant dans le sens des aiguilles d'une montre.
- Vérifier si le moyeu est bien fixé.

Démontage du moyeu :

- Sortir le rotor.
- Desserrer l'écrou du moyeu en tournant dans le sens inverse des aiguilles d'une montre, et tourner jusqu'au point de pression pour le retrait. Après avoir franchi ce point de pression, le moyeu se détache du cône de l'arbre moteur.
- Tourner l'écrou jusqu'à pouvoir soulever le moyeu de l'arbre moteur.

10.2.2 Insérer et retirer le rotor

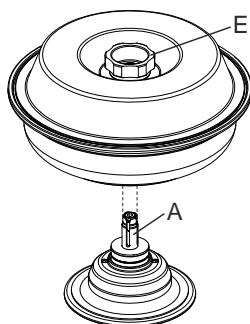

Insérer le rotor :

 La présence d'impuretés entre le moyeu et le rotor empêche au rotor d'avoir une position parfaite, et provoque un fonctionnement irrégulier du rotor. Si besoin est, nettoyer le moyeu (A) sur l'arbre moteur et le moyeu du rotor avant d'insérer le rotor.

- Soulever le rotor sur la poignée rotative (E) du couvercle, le poser à l'horizontale sur le moyeu (A) et appuyer dessous jusqu'à la butée.

Retirer le rotor :

- Tenir le rotor à la poignée rotative (E) du couvercle et l'ôter du moyeu (A).

11 Chargement du rotor



Des récipients standard de centrifugation en verre sont résistants jusqu' à un ACR de 4000 (DIN 58970, partie 2).

- Vérifier la stabilité d'assise du rotor.
- Dans le cas des rotors à balanciers, toutes les positions des rotors doivent être équipées avec les **mêmes** balanciers. Certains balanciers sont désignés avec le numéro de la place du rotor. Ces balanciers doivent exclusivement être installés dans la place de rotor correspondante. Les balanciers désignés par un numéro de set, comme S001/4 par exemple, doivent exclusivement être utilisés dans le set.
- Le chargement des rotors et des balanciers doit être nécessairement symétrique. Les conteneurs de centrifugation doivent être uniformément répartis sur toutes les positions du rotor. Pour les combinaisons possibles, voir le Chapitre "Anhang/Appendix, Rotoren und Zubehör/Rotors and accessories". Dans le cas des rotors à angle fixe, il faut charger tous les logements possibles du rotor, voir au chapitre "Annexe/Appendix, Rotors et accessoires/Rotors and accessories".

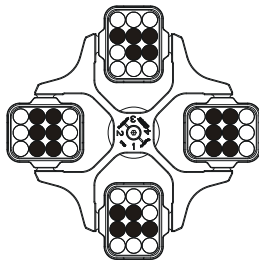

Rotor uniformément chargé

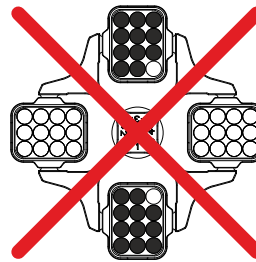

Non autorisé !
Rotor irrégulièrement chargé

- Certains dispositifs de suspension indiquent soit le poids maximum de la charge, soit le poids total maximum comprenant charge et dispositifs. Pour les cas d'exception, voir le chapitre "Centrifugation de matières et de mélanges d'une densité supérieure à 1,2 kg/dm³". L'indication du poids de la charge maximale comprend le poids total de l'adaptateur, du réservoir de centrifugation et du contenu.
- Dans le cas des récipients à garniture de caoutchouc, les récipients de centrifugation doivent avoir le même nombre de garnitures dans la partie inférieure.
- Remplissez les réservoirs de centrifugation uniquement en dehors de la centrifugeuse.
- La quantité maximale de remplissage indiquée par le fabricant pour les récipients de centrifugation ne doit pas être dépassée.

Pour les rotors angulaires, remplir les réservoirs de centrifugation de sorte que du liquide ne puisse pas être projeté à l'extérieur pendant le cycle de centrifugation

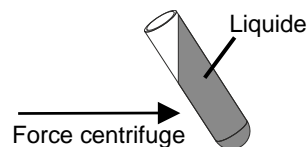

- Aucun fluide ne doit pénétrer dans les rotors angulaires et dans la cuve de centrifugeuse lors du chargement des rotors angulaires.
- Pendant le chargement de la suspension des balanciers, et pendant le balancement de la suspension dans le cycle de centrifugation, aucun fluide ne doit pénétrer dans la cuve de centrifugeuse..
- La hauteur de remplissage des récipients sera autant que possible égale pour maintenir les différences de poids entre les récipients de centrifugation aussi réduites que possible .

12 Poser dans le balancier l'adaptateur avec tenon de positionnement

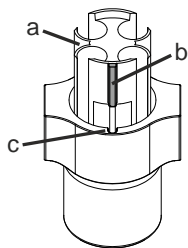

- Placer l'adaptateur (a) dans le balancier de sorte que la tenon de positionnement (b) se trouve dans la rainure (c) du balancier.



Le fait de ne pas placer correctement l'adaptateur (a) peut endommager les réservoirs de centrifugation durant le cycle de centrifugation.

13 Manipuler des systèmes de biosécurité



N'utiliser les systèmes de biosécurité qu'à l'état sec.

Avant toute utilisation du système de biosécurité, vérifier par un contrôle visuel le bon état de chaque pièce du système de biosécurité. En outre, vérifier la position correcte de, ou des bagues d'étanchéité du système de biosécurité.

Remplacer sans plus attendre toute pièce défectueuse du système de biosécurité.

Tout système de biosécurité défectueux n'est plus étanche du point de vue microbiologique.

Afin de garantir l'étanchéité, il faut fermer correctement le couvercle d'un système de biosécurité.

Vous trouverez au chapitre "Annexe/Appendix, rotors et accessoires/Rotors and accessories" la liste des systèmes de biosécurité pouvant être livrés. En cas de doute, veuillez vous renseigner auprès du fabricant.

13.1 Fermer et ouvrir les couvercles de systèmes de biosécurité

13.1.1 Couvercle à fermeture vissée et alésage dans la poignée tournante

Fermer le couvercle :

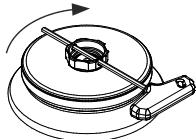

- Poser le couvercle sur le rotor, au centre.
- Insérer la clé fournie avec l'équipement dans l'alésage de la poignée tournante et fermer solidement le couvercle en le vissant dans le sens des aiguilles d'une montre.

Ouvrir le couvercle :

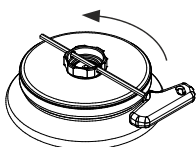

- Glisser la clé fournie dans la fureur de la poignée rotative et la tourner dans le sens inverse des aiguilles d'une montre jusqu'à ce que le couvercle puisse être retiré du rotor.

13.1.2 Couvrete avec fermeture à vis

Fermer le couvercle :

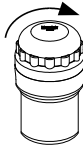

- Placer le couvercle sur le balancier.
- Bien fermer le couvercle en le tournant à la main dans le sens des aiguilles d'une montre.

Ouvrir le couvercle :

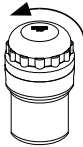

- Tourner le couvercle à la main dans le sens inverse des aiguilles d'une montre jusqu'à ce qu'il soit possible de retirer le couvercle du balancier.

13.1.3 Couvercle avec bride et fermeture par grenouillère

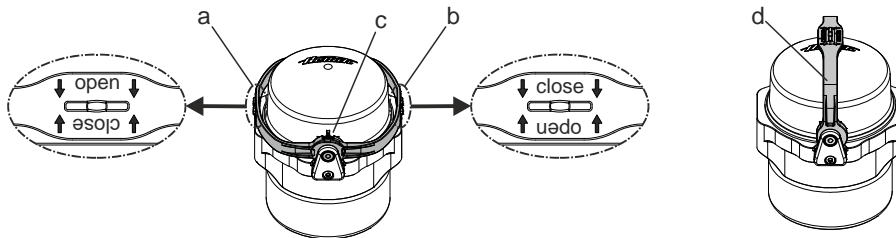

Fermer le couvercle :

- Faire pivoter la bride en position "↓ open ↓" (a). Les flèches de l'étiquette "↓ open ↓" doivent montrer vers le bas de sorte qu'il soit possible de lire "open".
- Placer le couvercle sur le balancier de sorte que les deux tenons du couvercle se trouvent dans les deux ouvertures de la bride (c).
- Faire pivoter la bride sur le côté opposé du balancier, en position "↓ close ↓" (b). Les flèches de l'étiquette "↓ close ↓" doivent montrer vers le bas de sorte qu'il soit possible de lire "close".



L'étrier doit se trouver sur le balancier de sorte que les balanciers puissent se balancer pendant le cycle de centrifugation.

- Pivoter l'étrier en position (d) pour pouvoir porter le système de biosécurité en le tenant par l'étrier.



L'étanchéité du système de biosécurité est aussi garantie dans la position de transport.

Nous ne pouvons plus garantir l'étanchéité du système de biosécurité si celui-ci est balancé durant le transport.

- Pour une manipulation plus facile pour poser et enlever le balancier, pivoter l'étrier en position (d) et fixer le balancier à l'étrier.

Ouvrir le couvercle :

- Faire pivoter la bride en position "↓ open ↓" (a). Les flèches de l'étiquette "↓ open ↓" doivent montrer vers le bas de sorte qu'il soit possible de lire "open".
- Retirer le couvercle du balancier.

13.2 Stockage de systèmes de biosécurité

- Entreposer les systèmes de biosécurité uniquement avec le couvercle ouvert afin d'éviter une détérioration des bagues d'étanchéité durant le stockage.

14 Organes de commande et indicateurs

Voir illustration sur la page 2.

Fig. 2, Fig. 3: Console des indicateurs et organes de commande

14.1 Bouton de réglage



Pour le réglage des paramètres individuels.
Pour faire décroître la valeur, tourner le bouton dans le sens anti-horaire. Pour augmenter la valeur, tourner le bouton dans le sens horaire.

14.2 Touches de la console de commande



- Touche de sélection des différents paramètres.
Les paramètres sont sélectionnés l'un après l'autre en appuyant sur la touche.



- Démarrer le cycle de centrifugation. La DEL intégrée dans la touche reste allumée pendant le cycle de centrifugation, tant que le rotor tourne.
- Centrifugation courte durée.
Le cycle de centrifugation est exécuté tant que l'action est maintenue sur la touche. La DEL intégrée dans la touche reste allumée pendant le cycle de centrifugation, tant que le rotor tourne.
- Sauvegarder les entrées et les modifications.



- Terminer le cycle de centrifugation.
Le rotor est décéléré à la vitesse de freinage sélectionnée. La DEL intégrée dans la touche, à droite, reste allumée jusqu'à l'arrêt du rotor. A l'arrêt du rotor, la DEL gauche intégrée dans la touche clignote. L'ARRET D'URGENCE est activé en appuyant deux fois sur la touche.
- Déverrouiller le couvercle.
La DEL de gauche intégrée dans la touche s'éteint.
- Quitter l'écran de saisie des paramètres.





- Commuter entre l'écran RPM et l'écran RCF.
Les valeurs RCF sont affichées en > <.



- Démarrer le refroidissement préliminaire.
La vitesse de refroidissement préliminaire est réglable. Elle est pré-réglée sur 2800 RPM.

14.3 Possibilités de réglage

PROG RCL	Position de programme du programme appelé.
t/min	Durée de fonctionnement. Réglable de 0 à 99 min, par pas de 1 min.
t/sec	Durée de fonctionnement. Réglable de 0 à 59 s, par pas de 1 seconde.
	Fonctionnement continu " ∞ ". Forcer sur zéro les paramètres t/min et t/sec .
RPM	Vitesse. Il est possible de régler une valeur numérique comprise entre 500 RPM et la vitesse de rotation maximale du rotor. Pour la vitesse maximale de rotation du rotor, se reporter au chapitre "Anhang/Appendix, Rotoren und Zubehör/Rotors and accessories". Réglable par pas de 10.
RAD/mm	Rayon de centrifugation. Valeurs en mm. Pour la saisie de rayon de centrifugation, voir le Chapitre "Anhang/Appendix, Rotoren und Zubehör/Rotors and accessories". La saisie de rayon n'est possible que quand l'écran RCF (> RCF <) est sélectionné.
RCF	Accélération relative de centrifugation. Il est possible de régler une valeur numérique dont découle une vitesse de rotation située entre 500 RPM et la vitesse maximale de rotation du rotor. Réglage par incréments de 1 jusqu'à 100, par incréments de 10 à partir de 100. La valeur RCF est arrondie automatiquement au chiffre supérieur/inférieur en fonction de l'incrément de vitesse. La saisie de RCF n'est possible que quand l'écran RCF (> RCF <) est sélectionné.
	Etages de montée en puissance de 1 à 9. Etage 9 = temps de montée en puissance le plus court, étage 1 = temps de montée en puissance le plus long.
	Etages de décélération de 0 à 9. Etage 9 = temps de décélération le plus court, étage 1 = étage de décélération long, étage 0 = étage de décélération le plus long (décélération par inertie, sans freinage).
T/°C	Valeur de température de consigne (uniquement sur centrifugeuse avec refroidissement). Réglage de -20 °C à +40 °C, par incréments de 1 °C. La température la plus basse pouvant être établie est fonction du rotor (voir le Chapitre "Anhang/Appendix, Rotoren und Zubehör/Rotors and accessories").
PROG STO	Position de programme sur laquelle le programme est sauvegardé. 9 programmes peuvent être sauvegardés (positions de programme 1 - 2 - 3 - ... 9). La position de programme # sert de mémoire temporaire pour la modification des réglages.

15 Saisie des paramètres de centrifugation



Après sélection de paramètres et pendant la sélection des paramètres, l'indicateur bascule sur les valeurs précédentes si aucune action n'exécute sur les touches pendant 8 secondes. Il est alors nécessaire de recommencer la saisie des paramètres.

- Sélectionner l'indicateur RPM ou RCF en appuyant sur la touche **(RCF)**. Les valeurs RCF sont affichées en **> <**.
- Sélectionner les paramètres souhaités en appuyant sur la touche **(SELECT)** et ajuster sur le bouton radio **○**. Afin de régler le fonctionnement continu, il faut mettre les paramètres **t/min** et **t/sec** à zéro avec le bouton rotatif **○**. Le fonctionnement continu est indiqué dans l'affichage par le symbole "∞".
- Après entrée de tous les paramètres, appuyer sur la touche **(START/IMPULS)** pour sauvegarder les réglages sur la position de programme **#**. La saisie est confirmée par affichage de ***** ok ***** pendant un instant.



Les données de la position de programme **#** sont écrasées par entrée de paramètres et en appuyant sur la touche **(START/IMPULS)**.

16 Programmation

16.1 Saisie / Modification de programme



Après sélection de paramètres et pendant la sélection des paramètres, l'indicateur bascule sur les valeurs précédentes si aucune action n'exécute sur les touches pendant 8 secondes. Il est alors nécessaire de recommencer la saisie des paramètres.

- Sélectionner l'indicateur RPM ou RCF en appuyant sur la touche **(RCF)**. Les valeurs RCF sont affichées en **> <**.
- Sélectionner les paramètres souhaités en appuyant sur la touche **(SELECT)** et ajuster sur le bouton radio **○**. Afin de régler le fonctionnement continu, il faut mettre les paramètres **t/min** et **t/sec** à zéro avec le bouton rotatif **○**. Le fonctionnement continu est indiqué dans l'affichage par le symbole "∞".
- Sélectionner le paramètre **PROG STO** sur le bouton radio **(SELECT)** et régler la position de programme souhaitée sur le bouton radio **○**.
- Pour sauvegarder les configurations sous la position de programme souhaitée, appuyer sur la touche **(START/IMPULS)**. La saisie est confirmée par l'affichage bref de ***** ok *****.
Si vous appuyez sur la touche **(START/IMPULS)**, sans avoir sélectionné le paramètre **PROG STO**, les réglages sont alors toujours enregistrés sur l'emplacement de programme **#**.



Les données précédentes de la position de programme sont écrasées par écriture.

16.2 Appel de programme

- Sélectionner le paramètre **PROG RCL** en appuyant sur la touche **(SELECT)** et configurer la position de programme souhaitée sur le bouton radio **○**.
- Appuyer sur la touche **(START/IMPULS)**. Les données de centrifugation pour la position de programme sélectionnée sont affichées.
- Vérifier les paramètres en appuyant sur la touche **(SELECT)**.
Pour quitter l'afficheur des paramètres, appuyer sur la touche **(OPEN/STOP)** ou attendre 8 secondes sans exécuter aucune action.

17 Centrifugation



Durant un processus de centrifugation, aucune personne, matière dangereuse et aucun objet ne doivent se trouver dans une zone de sécurité de 300 mm autour de la centrifugeuse selon EN / IEC 61010-2-020.



L'entraînement est stoppé en phase de montée en puissance si la différence de tare admissible a été dépassée pendant le chargement du rotor, l'indicateur de déséquilibre s'allume et la mention **IMBALANCE** est affichée.

La centrifugation peut être stoppée n'importe quand en appuyant sur la touche **OPEN / STOP**.

Il est possible de sélectionner et de modifier tous les paramètres pendant la centrifugation (voir le Chapitre "Saisie des paramètres de centrifugation").

Il est possible de basculer n'importe quand sur l'indicateur RPM et RCF en appuyant sur la touche **RCF**. Pour travailler avec l'indicateur RCF, il est nécessaire d'entrer le brayon de centrifugation.

Après affichage de **OPEN / OEFFNEN** (= OUVRIR) la commande de centrifugeuse n'est possible qu'après avoir ouvert le couvercle une fois.

Si **R xx n-max xxxxx** est affiché, la marche de centrifugation n'a pas été exécutée en raison du changement du rotor, voir chapitre "Identification de rotor".

- Mettre la centrifugeuse sous tension. Amener l'interrupteur en position I.
- Charger le rotor et fermer le couvercle de centrifugeuse.

17.1 Centrifugation avec sélection de temps préalable

- Régler le temps et appeler un programme avec sélection de temps préalable (voir le Chapitre "Programmation").
- Appuyer sur la touche **START / IMPULS**. La DEL incorporée dans la touche **START / IMPULS** reste allumée tant que le rotor tourne.
- La décélération selon l'étage de freinage sélectionné est exécutée après écoulement du temps ou interruption de la centrifugation en appuyant sur la touche **OPEN / STOP**. L'étage de freinage est affiché.

Pendant la centrifugation, l'afficheur donne la vitesse du rotor ou la valeur RCF résultants, la température des échantillons (uniquement sur centrifugeuse avec refroidissement) et la durée restante.

17.2 Centrifugation continue

- Ajuster sur l'icône ∞ ou appeler un programme de centrifugation continue (voir le Chapitre "Programmation").
- Appuyer sur la touche **START / IMPULS**. La DEL incorporée dans la touche **START / IMPULS** reste allumée tant que le rotor tourne. Le compte du temps commence à 00:00.
- Pour stopper la centrifugation, appuyer sur la touche **OPEN / STOP**. La décélération est exécutée selon l'étage de freinage sélectionné. L'étage de freinage est affiché.

Pendant la centrifugation, l'afficheur donne la vitesse du rotor ou la valeur RCF résultants, la température des échantillons (uniquement sur centrifugeuse avec refroidissement) et la durée restante.

17.3 Centrifugation rapide

- Appuyer sur la touche **START / IMPULS** et maintenir l'action. La DEL incorporée dans la touche **START / IMPULS** reste allumée tant que le rotor tourne. Le compte du temps commence à 00:00.
- Pour stopper la centrifugation rapide, cesser l'action sur la touche **START / IMPULS**. La décélération est exécutée selon l'étage de freinage sélectionné. L'étage de freinage est affiché.

Pendant la centrifugation, l'afficheur donne la vitesse du rotor ou la valeur RCF résultants, la température des échantillons (uniquement sur centrifugeuse avec refroidissement) et la durée restante.

18 Arrêt d'urgence

- Appuyer 2 fois sur la touche **OPEN / STOP**

La décélération est exécutée sur l'étage 9 (temps de décélération le plus court) en cas d'arrêt d'urgence L'étage de freinage 9 est affiché.

Si l'étage de freinage 0 a été sélectionné, la décélération est plus longue, pour des raisons technique, que pour l'étage de freinage 9.

19 Signal sonore

Le signal sonore retentit :

- en présence d'un défaut à un intervalle de 2 s.
- au terme de la centrifugation et après immobilisation du rotor, à un intervalle de 30 s.

Le signal sonore cesse après ouverture du couvercle, en appuyant sur une touche quelconque.

Pour activer / désactiver le signal sonore après la centrifugation, alors que le rotor est immobilisé, procéder comme suit :

- Appuyer sur la touche **[SELECT]** pendant 8 s.
Après 8 s, la mention **SOUND / BELL** est affichée.
- Régler sur le bouton radio **OFF** (arrêt) et **ON** (marche).
- Appuyer sur la touche **[START/IMPULS]** pour sauvegarder le réglage.
La saisie est confirmée par affichage de ***** ok ***** pendant un instant.

20 Interrogation du compteur de durée de fonctionnement

Il n'est possible d'interroger le compteur de durée de fonctionnement qu'à l'arrêt du rotor.

- Appuyer sur la touche **[SELECT]** pendant 8 s.
Après 8 s, la mention **SOUND / BELL** est affichée.
- Appuyer une nouvelle fois sur la touche **[SELECT]**
La durée de fonctionnement (**CONTROL:**) de la centrifugeuse est affichée.
- Pour quitter l'interrogation de durée de fonctionnement, appuyer sur la touche **[OPEN/STOP]**.

21 Refroidissement (uniquement sur centrifugeuse avec refroidissement)

La température de consigne peut être réglée sur une plage de -20 °C à +40 °C. Le minimum de température possible est fonction du rotor (voir le Chapitre "Anhang/Appendix, Rotoren und Zubehör/Rotors and accessories").

21.1 Refroidissement en veilleuse

A l'arrêt du rotor et lorsque le couvercle est fermé, le bol de centrifugeuse est refroidi à la température sélectionnée. La température de consigne est indiquée sur l'afficheur.

Après une marche centrifuge, le refroidissement se met en veille après une temporisation, et **OPEN / OEFFNEN** s'affiche. Vous pouvez régler la temporisation de 1 à 5 minutes en étapes de 1 minute. Elle est pré-réglée sur 1 minute.

Vous pouvez régler la temporisation lorsque le rotor est à l'arrêt et le couvercle ouvert en procédant comme suit :

- Appuyer sur la touche **[X]** pendant 8 secondes.
Au bout de 8 secondes, la mention **t/min = X** s'affiche.
- Régler la temporisation avec le bouton tournant **○**.
- Appuyer sur la touche **[START/IMPULS]** pour sauvegarder le réglage.
La saisie est confirmée par affichage de ***** ok ***** pendant un instant.

Pour quitter l'affichage temporisation, appuyer sur la touche **[OPEN/STOP]** ou ne pas appuyer de touche pendant 8 secondes.

21.2 Pré-refroidissement du rotor

- Appuyer sur la touche **[X]**. La DEL incorporée dans la touche **[START/IMPULS]** reste allumée tant que le rotor tourne.
- Pour abandonner le refroidissement préliminaire, appuyer sur la touche **[OPEN/STOP]**. La décélération est exécutée selon l'étage de freinage sélectionné. L'étage de freinage est affiché.

Pendant la centrifugation, l'afficheur donne la vitesse du rotor ou la valeur RCF résultants, la température des échantillons et la durée restante.

Vous pouvez régler la vitesse du pré-refroidissement de 500 tours/min jusqu'à la vitesse maximale du rotor en étapes de 10. Elle est pré-réglée sur 2800 RPM.

La vitesse de refroidissement préliminaire est réglée de la manière suivante, alors que le rotor est à l'arrêt et que le couvercle est ouvert:

- Appuyer sur la touche **[X]** pendant 8 secondes.
Après 8 secondes, la mention **t/min = X** est affichée.
- Appuyer une nouvelle fois sur la touche **[X]**
La vitesse de pré-refroidissement réglée en tours/min = **XXXX** s'affiche.
- Régler la vitesse de refroidissement préliminaire sur le bouton radio **○**.
- Appuyer sur la touche **[START/IMPULS]** pour sauvegarder le réglage.
La saisie est confirmée par affichage de ***** ok ***** pendant un instant.

Pour quitter l'affichage de la vitesse de pré-refroidissement, appuyer la touche **[OPEN/STOP]** ou ne pas appuyer de touche pendant 8 secondes.

22 Accélération centrifuge relative (RCF)

L'accélération centrifuge relative (RCF) est indiquée en tant que multiple de l'accélération gravitationnelle (g). Il s'agit d'une valeur dépourvue d'unité, qui sert à la comparaison entre la puissance de séparation et de sédimentation.

Le calcul s'effectue à l'aide de la formule suivante:

$$\text{RCF} = \left(\frac{\text{RPM}}{1000} \right)^2 \times r \times 1,118 \quad \Rightarrow \quad \text{RPM} = \sqrt{\frac{\text{RCF}}{r \times 1,118}} \times 1000$$

RCF = accélération centrifuge relative

RPM = régime

r = rayon de centrifugation en mm = distance qui sépare le centre de l'axe de rotation du fond de la cuve de centrifugation. Rayon de centrifugation voir chapitre "Anhang/Appendix, Rotoren und Zubehör/Rotors and accessories".



L'accélération centrifuge relative (RCF) est dépendante du régime et du rayon de centrifugation.

23 Centrifugation de matières et de mélanges d'une densité supérieure à 1,2 kg/dm³

Dans le cas de la centrifugation à la vitesse maximale, la densité des substances et des mélanges de substances ne doit pas excéder 1,2 kg/dm³. Réduire la vitesse de rotation pour les matières et mélanges ayant une densité supérieure.

La vitesse de rotation autorisée se calcule de la manière suivante:

$$\text{Vitesse de centrifugation lente (n}_{\text{red}}) = \sqrt{\frac{1,2}{\text{densité supérieure [kg/dm}^3]}} \times \text{Vitesse de rotation maximum [RPM]}$$

Exemple: Vitesse de rotation maximum RPM 4000, densité 1,6 kg/dm³

$$n_{\text{red}} = \sqrt{\frac{1,2 \text{ kg/dm}^3}{1,6 \text{ kg/dm}^3}} \times 4000 \text{ RPM} = 3464 \text{ RPM}$$

Dans le cas exceptionnel de dépassement de la charge maximum indiquée sur la suspension, réduire également la vitesse de rotation.

La vitesse de rotation autorisée se calcule de la manière suivante:

$$\text{Vitesse de centrifugation lente (n}_{\text{red}}) = \sqrt{\frac{\text{Charge maximum [g]}}{\text{Charge réelle [g]}}} \times \text{Vitesse de rotation maximum [RPM]}$$

Exemple: Vitesse de rotation maximum RPM 4000, Charge maximum 300 g, Charge réelle 350 g

$$n_{\text{red}} = \sqrt{\frac{300 \text{ g}}{350 \text{ g}}} \times 4000 \text{ RPM} = 3703 \text{ RPM}$$

En cas d'incertitude, prendre contact avec le fabricant.

24 Identification du rotor

Une identification du rotor est effectuée après le démarrage de chaque cycle de centrifugation.

Si le rotor a été remplacé, le cycle de centrifugation s'interrompt après l'identification du rotor. L'afficheur indique le code (R xx) et la vitesse de rotation maximale (n-max=xxxxx) du rotor.



Toute commande ultérieure de la centrifuge n'est possible qu'après une ouverture du couvercle.

Si la vitesse de rotation maximale du rotor utilisé est inférieure à la vitesse de rotation paramétrée, la vitesse de rotation effective est limitée à la vitesse de rotation maximale du rotor.

25 Déverrouillage d'urgence

En cas de panne de courant, le couvercle ne peut pas être déverrouillé avec le moteur. Il est nécessaire d'exécuter un déverrouillage manuel.



Avant d'exécuter le déverrouillage manuel, retirer la fiche de l'alimentation.
Attendre que le rotor est à l'arrêt pour ouvrir le couvercle.

Voir illustration sur la page 2.

- Couper l'interrupteur de secteur (position de l'interrupteur "0").
- Regarder par la fenêtre située sur le couvercle pour s'assurer que le rotor est immobile.
- Insérer horizontalement la clé mâle coudée à six pans creux dans l'orifice (Fig. 1, A) et tourner avec précaution d'un demi-tour dans le sens des aiguilles d'une montre jusqu'à ce que le couvercle puisse être ouvert.
- Retirer la clé à six pans hors de l'alésage.
- Si, après la remise sous tension de la centrifugeuse, la DEL gauche de la touche **OPEN / STOP** clignote, appuyer la touche **OPEN / STOP** pour que le verrouillage motorisé du couvercle revienne en position de base (ouvert).

26 Entretien et maintenance



L'appareil est peut-être contaminé.



Retirer la prise de secteur avant de nettoyer.
Avant d'utiliser une procédure de nettoyage ou de décontamination autre que celle recommandée par le fabricant, l'utilisateur vérifiera auprès du fabricant que la procédure prévue n'endommage pas l'appareil.

- Ne pas nettoyer centrifuges, rotors et accessoires dans un lave-vaisselle.
- Seul le nettoyage manuel et une désinfection liquide sont autorisés.
- La température de l'eau doit être située entre 20 et 25°C.
- Utiliser exclusivement des agents de nettoyage ou de désinfection qui :
 - ont un pH de 5 à 8,
 - ne contiennent pas de substances caustiques, de peroxyde, composés chlorés, acides ni alcalins.
- Respecter impérativement les consignes spéciales d'utilisation données par le fabricant des agents de nettoyage et de désinfection, afin de prévenir la corrosion par les agents de nettoyage et de désinfection.

26.1 Centrifugeuse (boîtier, couvercle et cuve)

26.1.1 Entretien et nettoyage des surfaces

- Nettoyer régulièrement le boîtier de la centrifugeuse et le compartiment de centrifugation et les laver en cas de besoin avec du savon ou un détergent doux et un chiffon humide. Ces opérations sont nécessaires pour garantir l'hygiène et pour prévenir la corrosion par la présence durable d'impuretés.
- Substances des nettoyants adéquats :
savon, agents anioniques et non ioniques.
- Après utilisation des nettoyants, enlevez les résidus en essuyant l'appareil avec un chiffon humide.
- Séchez immédiatement les surfaces après nettoyage.
- Sécher le bol avec un chiffon absorbant en cas de dépôt d'eau de condensation dans le bol de la centrifugeuse.
- Frotter légèrement le joint d'étanchéité en caoutchouc du compartiment de centrifugation, après chaque nettoyage, avec de la poudre de talc ou un produit d'entretien pour caoutchouc.
- Vérifiez tous les ans le bon état de la cuve.



N'utilisez plus la centrifugeuse si elle présente des dommages susceptibles de porter atteinte à la sécurité.
Auquel cas, contactez le service après-vente.

26.1.2 Désinfection des surfaces

- Le bol de la centrifugeuse doit être nettoyé immédiatement dans le cas où un matériau infectieux a pénétré dans le bol de la centrifugeuse.
- Substances des désinfectants adéquats :
éthanol, n-propanol, éthylènehexanol, agents anioniques, inhibiteurs de corrosion.
- Après utilisation de désinfectants, enlevez les résidus en essuyant l'appareil avec un chiffon humide.
- Séchez immédiatement les surfaces après désinfection.

26.1.3 Décontamination de substances radioactives

- L'agent employé doit expressément convenir pour une décontamination de substances radioactives.
- Substances des agents adaptés à une décontamination des substances radioactives : agents anioniques, non ioniques agents, éthanol polyhydre.
- Après décontamination des substances radioactives, enlevez les résidus en essuyant l'appareil avec un chiffon humide.
- Séchez immédiatement les surfaces après décontamination des substances radioactives.

26.2 Rotors et accessoires

26.2.1 Nettoyage et entretien

- Afin de prévenir la corrosion et toute modification des matériaux, il faut nettoyer régulièrement les rotors et les accessoires avec du savon ou un détergent doux et un chiffon humide. Il est vivement recommandé d'effectuer un nettoyage au moins une fois par semaine. Enlevez immédiatement les impuretés.
 - Substances des nettoyants adéquats : savon, agents anioniques et non ioniques.
 - Après utilisation de nettoyants, enlevez les résidus en rinçant à l'eau claire (uniquement à l'extérieur de la centrifugeuse) ou en essuyant les surfaces avec un chiffon humide.
 - Séchez rotors et accessoires immédiatement après nettoyage.
 - Après séchage, les rotors d'angle, les réservoirs et la suspension en aluminium seront enduits d'une pellicule de graisse sans acide, par exemple la vaseline.
 - Nettoyer une fois par semaine les bagues d'étanchéité des systèmes de biosécurité.
- Les bagues d'étanchéité sont fabriquées en silicone. Afin de garantir l'étanchéité des systèmes de biosécurité, ne pas traiter les bagues d'étanchéité, après leur nettoyage ou autoclave, avec du talc en poudre. Avant toute utilisation du système de biosécurité, vérifier par un contrôle visuel le bon état de chaque pièce du système de biosécurité. En outre, vérifier la position correcte de, ou des bagues d'étanchéité du système de biosécurité.

Remplacer sans plus attendre toute pièce défectueuse du système de biosécurité.

Remplacer immédiatement toute bague d'étanchéité présentant des signes de formation de fissure, de fragilisation ou d'usure. Remplacer tout le couvercle en cas de couvercle ayant des bagues d'étanchéité non remplaçables.

Vous trouverez au chapitre "Annexe/Appendix, rotors et accessoires/Rotors and accessories" la liste des systèmes de biosécurité pouvant être livrés.

- Déposer le rotor au moins une fois par mois, nettoyer et enduire l'arbre d'entraînement d'une pellicule de graisse pour prévenir la corrosion par la présence d'humidité entre le rotor et l'arbre d'entraînement.
- Vérifier une fois par semaine l'état des rotors et des accessoires afin de détecter les éventuelles détériorations issues de l'usure et l'oxydation.

Pour les rotors à oscillation, vérifier surtout la zone de portée des tourillons et pour les balanciers, vérifier les rainures et le fond pour détecter les éventuelles fissures.

Exemple : fissures dans la rainure.

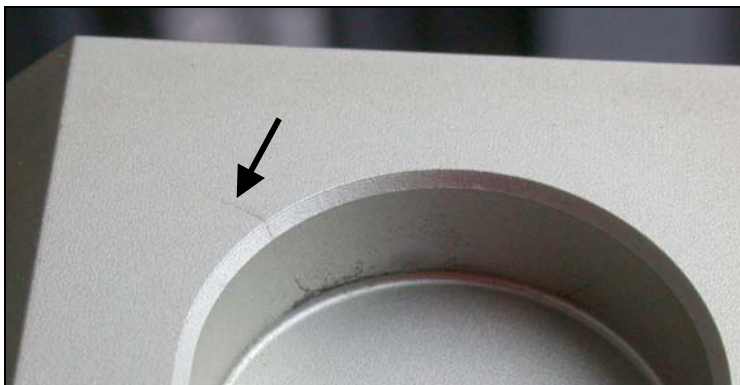

Les rotors et les accessoires usés et endommagés par la corrosion ne doivent plus être utilisés.

- Vérifier chaque semaine la stabilité de fixation du rotor.

26.2.2 Désinfection

- Si les rotors ou accessoires sont infectés, procédez à une désinfection appropriée.
- Substances des désinfectants adéquats :
éthanol, n-propanol, éthylènehexanol, agents anioniques, inhibiteurs de corrosion.
- Après utilisation de désinfectants, enlevez les résidus en rinçant à l'eau claire (uniquement à l'extérieur de la centrifugeuse) ou en essuyant les surfaces avec un chiffon humide.
- Séchez rotors et accessoires immédiatement après désinfection.

26.2.3 Décontamination de substances radioactives

- L'agent employé doit expressément convenir pour une décontamination de substances radioactives.
- Substances des agents adaptés à une décontamination des substances radioactives :
agents anioniques, agents non ioniques, éthanol polyhydre.
- Après décontamination des substances radioactives, enlevez les résidus en rinçant à l'eau claire (uniquement à l'extérieur de la centrifugeuse) ou en essuyant les surfaces avec un chiffon humide.
- Séchez immédiatement rotors et accessoire après décontamination des substances radioactives.

26.2.4 Goupilles de fixation

Les goupilles de fixation des rotors à amortissement doivent être graissées régulièrement (graisse de lubrification Hettich n° 4051) de manière à assurer le balancement régulier de la suspension.

26.2.5 Rotors et accessoires à durée d'utilisation limitée

L'utilisation de certains rotors, balanciers et accessoires est limitée dans le temps.

Ces limites sont indiquées par le nombre maximum de cycles ou la date limite d'utilisation et le nombre maximum de cycles, ou simplement la date limite d'utilisation, par ex. :

- "einsetzbar bis Ende: IV. Quartal 2011 / usable until end of: IV. trimestre 2011" (utilisation autorisée jusqu'à fin: IV. trimestre 2011) ou
"einsetzbar bis Ende Monat/Jahr: 10/2011 / usable until end of month/year: 10/2011" (utilisation autorisée jusqu'à fin mois/an : 10/2011)
- "max. Laufzyklen / max. cycles: 40000" (nombre ma. de cycles 40000)



Pour des raisons de sécurité, l'utilisation de rotors, balanciers et accessoires n'est plus autorisée dès que le nombre maximum de cycles désigné ou la date limite d'utilisation inscrite sont atteints.

26.3 Autoclave

Vous pouvez stériliser par autoclave à 121°C / 250°F (20 min) les accessoires suivants :

- rotors à oscillation
- rotors angulaires en aluminium
- balancier en métal
- couvercle avec bio-étanchéité
- adaptateur

Nous ne pouvons faire aucune déclaration sur le degré de stérilisation.



Avant autoclave, retirez les couvercles des rotors et réservoirs.

La stérilisation en autoclave accélère le processus de vieillissement des matières plastiques. Elle peut également modifier la couleur des plastiques.

Le couvercle des rotors 1515 et 1515-A ne peut être stérilisé par autoclave que 10 fois. Pour des raisons de sécurité, il faut le remplacer ensuite.

Après autoclave, vérifier si les rotors et accessoires sont en bon état (contrôle visuel), remplacer immédiatement toute pièce éventuellement défectueuse.

Remplacer immédiatement toute bague d'étanchéité présentant des signes de formation de fissure, de fragilisation ou d'usure.

Remplacer tout le couvercle en cas de couvercle ayant des bagues d'étanchéité non remplaçables.

Afin de garantir l'étanchéité des systèmes de biosécurité, ne pas traiter les bagues d'étanchéité, après autoclave, avec du talc en poudre.

26.4 Réservoirs de centrifugation

- En cas de fuite ou de rupture de récipients de centrifugation, il faut éliminer tous les morceaux de récipients cassés, les fragments de verre et les substances centrifugées écoulées.
- Les amortisseurs antivibrations ainsi que les caoutchouc intermédiaires des rotors doivent être remplacés après un bris de verre.



Les fragments de verre restants peuvent entraîner d'autres bris de verre !

- S'il s'agit d'un matériau infectieux, exécuter immédiatement une désinfection.

27 Défauts

Si l'erreur ne peut pas être éliminée d'après le tableau des défauts, il faut alors avertir le service après-vente.

Veuillez indiquer le type de centrifuge et le numéro de série. Les deux numéros sont indiqués sur la plaque signalétique de la centrifugeuse.



Effectuer une RÉINITIALISATION DU SECTEUR :

- Couper l'interrupteur de secteur (position de l'interrupteur "0").
- Attendre au moins 10 secondes et refermer ensuite l'interrupteur de secteur (position de l'interrupteur "I").

Message / Erreur		Origine	Solution	
Pas de message	---	Pas de tension Déclenchement du fusible protecteur contre surintensité.	<ul style="list-style-type: none"> - Contrôler la tension d'alimentation - Secteur en marche 	
TACHO - ERROR	1, 2, 96	Tachymètre défectueux. Défaut de l'électronique du moteur.	<ul style="list-style-type: none"> - Ouvrir le couvercle. - Couper l'interrupteur de secteur (position de l'interrupteur "0"). 	
CONTROL - ERROR	8	Erreur du verrouillage ou de la fermeture du capot.	<ul style="list-style-type: none"> - Attendre au moins 10 secondes. - Tourner vigoureusement le rotor à la main. - Refermer l'interrupteur de secteur (position de l'interrupteur "I"). Le rotor doit fonctionner pendant la mise en marche. 	
IMBALANCE	---	Le rotor est chargé de manière non symétrique.	<ul style="list-style-type: none"> - Ouvrir le capot. - Vérifier le chargement du rotor, voir au chapitre "Chargement du rotor". - Répéter le cycle de centrifugation. 	
CONTROL - ERROR	4, 6	Erreur du verrouillage ou de la fermeture du capot.	<ul style="list-style-type: none"> - Effectuer une RÉINITIALISATION DU SECTEUR. 	
N > MAX	5	Survitesse		
N < MIN	13	Vitesse trop basse		
MAINS INTERRUPT	---	Interruption du secteur pendant le cycle de centrifugation. (Le cycle de centrifugation n'est pas terminé.)	<ul style="list-style-type: none"> - Ouvrir le capot. - Appuyer sur la touche START / IMPULS. - En cas de besoin, répéter le cycle de centrifugation. 	
ROTORCODE	10.1, 10.2	Erreur codage du rotor	<ul style="list-style-type: none"> - Ouvrir le capot. 	
CONTROL-ERROR	21, 22, 25, 27, 29	Défaut / Panne de l'électronique.	<ul style="list-style-type: none"> - Effectuer une RÉINITIALISATION DU SECTEUR. 	
CONTROL-ERROR	23	Défaut / Panne d'un organe de commande.		
SER I/O - ERROR	30, 31, 33, 36	Défaut / Panne de l'électronique.		
° C * - ERROR	51 - 53, 55	Défaut / Panne de l'électronique.		
FU / CCI - ERROR	60 - 64, 67, 68, 82 - 86	Défaut / Panne de l'électronique / du moteur.		
SYNC-ERROR	90	Défaut / Panne de l'électronique.		
SENSOR-ERROR	91 - 93	Fehler / Defekt Unwuchtsensor		
KEYBOARD-ERROR	---	Défaut / Panne d'un organe de commande.		
NO ROTOR	---	Pas de rotor intégré		<ul style="list-style-type: none"> - Ouvrir le capot. - Monter rotor.
N > ROTOR MAX	---	Vitesse de rotation paramétrée dans le programme sélectionné supérieure à la vitesse maximale de rotation du rotor.		<ul style="list-style-type: none"> - Vérifier la vitesse du programme sélectionnée - Corriger la vitesse du programme sélectionnée
		Le rotor a été remplacé. Le rotor actuellement en place a une vitesse de rotation maximale supérieure à celle du rotor utilisé précédemment et il n'a pas encore été identifié par l'identification du rotor.	<ul style="list-style-type: none"> - Paramétrer une vitesse de rotation inférieure ou égale à la vitesse de rotation maximale du rotor utilisé précédemment. Appuyer sur la touche START / IMPULS pour procéder à l'identification du rotor, voir chapitre "Identification du rotor". 	

28 Renvoi d'appareils au fabricant



Avant de renvoyer l'appareil, il faut monter le dispositif de fixation pour le transport.

Dans le cas où l'appareil ou ses accessoires doivent être retournés à la société Andreas Hettich GmbH & Co. KG, il faut les décontaminer et les nettoyer avant expédition, dans le but d'assurer la protection des personnes, de l'environnement et du matériel.

Nous nous réservons le droit de refuser des appareils ou des accessoires contaminés.

Nous facturons au client les frais de nettoyage et de désinfection.

Vous voudrez bien manifester votre compréhension pour cette réglementation.

29 Élimination des déchets

Avant de mettre l'appareil au rebut, vous devez le décontaminer et le nettoyer pour la protection des personnes, de l'environnement et du matériel.

Les dispositions légales en vigueur doivent être respectées lors de l'élimination de l'appareil.

Conformément à la directive 2002/96/CE (WEEE), tous les appareils livrés après le 13.08.2005 ne doivent plus être jetés avec les déchets ménagers. L'appareil fait partie du groupe 8 (dispositifs médicaux) et est classé dans le domaine "Business-to-Business".



Le symbole de la poubelle barrée d'une croix indique que l'appareil ne doit pas être jeté avec les déchets ménagers.

Les dispositions relatives à l'élimination des déchets des différents pays de l'UE peuvent varier. Veuillez-vous adresser en cas de besoin à votre fournisseur.

Indice

1	Usò previsto.....	84
2	Rischi residui	84
3	Dati tecnici.....	85
4	Indicazioni inerenti la sicurezza	88
5	Significato dei simboli	90
6	Contenuto della fornitura	90
7	Disimballo della centrifuga.....	90
8	Messa in funzione.....	91
9	Apertura e chiusura del coperchio	91
9.1	Apertura del coperchio	91
9.2	Chiusura del coperchio.....	91
10	Montaggio e smontaggio del rotore.....	92
10.1	Rotore con dado di bloccaggio.....	92
10.2	Rotore senza dado di bloccaggio.....	92
10.2.1	Montaggio e smontaggio del mozzo	92
10.2.2	Installazione ed estrazione del rotore	92
11	Carico del rotore.....	93
12	Applicare nel gancio l'adattatore con il perno di posizionamento	94
13	Impiego dei sistemi di biosicurezza.....	94
13.1	Chiudere ed aprire il coperchio dei sistemi di biosicurezza.....	94
13.1.1	Coperchio con chiusura a vite e foro nella manopola	94
13.1.2	Coperchio con chiusura a vite.....	94
13.1.3	Coperchio con staffa e chiusura in bloccaggio a leva	95
13.2	Immagazzinaggio dei sistemi di biosicurezza	95
14	Elementi di operazione e visualizzazione.....	95
14.1	Manopola	95
14.2	Tasti del display	96
14.3	Possibilità di regolazione	96
15	Inserire i parametri di centrifugazione	97
16	Programmazione	97
16.1	Inserimento/Variazione del programma	97
16.2	Richiamo del programma.....	97
17	Centrifugazione	97
17.1	Centrifugazione con tempo preimpostato	98
17.2	Corsa continua.....	98
17.3	Centrifugazione breve.....	98
18	Arresto di emergenza	98
19	Segnale acustico.....	98
20	Consultazione delle ore di funzionamento.....	98
21	Raffreddamento (solo per centrifuga con raffreddamento).....	99
21.1	Raffreddamento-Standby	99
21.2	Pre-raffreddamento del rotore.....	99
22	Accelerazione centrifuga relativa (RCF).....	99

23	Centrifugazione di sostanze o di miscele di sostanze con densità maggiore di 1,2 kg/dm ³	100
24	Riconoscimento del rotore.....	100
25	Sblocco di emergenza	100
26	Pulizia e manutenzione	101
26.1	Centrifughe (scatola, coperchio e vano di centrifugazione).....	101
26.1.1	Cura e pulizia delle superfici	101
26.1.2	Disinfezione delle superfici	101
26.1.3	Rimuovere contaminazioni radioattive	101
26.2	Rotori ed accessori	102
26.2.1	Pulizia e cura	102
26.2.2	Disinfezione	102
26.2.3	Rimuovere contaminazioni radioattive	103
26.2.4	Perni di trascinamento	103
26.2.5	Rotori ed accessori con limitata durata di impiego.....	103
26.3	Trattamento in autoclave.....	103
26.4	Contenitori centrifuga	103
27	Guasti	104
28	Rispedizione di apparecchi.....	105
29	Smaltimento	105
30	Anhang / Appendix.....	106
30.1	Rotoren und Zubehör / Rotors and accessories.....	106

1 Uso previsto

Per quanto riguarda l'apparecchio in oggetto, si tratta di un prodotto medico (centrifuga di laboratorio) ai sensi della direttiva Diagnostici in vitro (IVD) 98/79/CE.

La centrifuga è stata concepita per separare materiali o miscele di materiali che hanno una densità massima di 1,2 kg/dm³. Fanno parte in particolare di questa classificazione i campioni per le preparazioni a scopi diagnostici In-vitro nella medicina umana.

Le centrifuga è destinata solo a questo scopo d'impiego.

Un diverso od ulteriore tipo di impiego non è regolamentare. La ditta Andreas Hettich GmbH & Co. KG non si prende carico di alcuna responsabilità nel caso di danni da ciò derivanti.

Per l'impiego a norma è previsto anche il rispetto di tutte le avvertenze riportate nelle istruzioni d'uso ed il rispetto degli interventi di ispezione e di manutenzione.

2 Rischi residui

L'apparecchio è costruito secondo lo stato attuale della tecnica e le regole riconosciute riguardanti la tecnica della sicurezza. In caso di uso ed impiego non regolamentari possono insorgere pericoli mortali per l'utilizzatore o per terzi risp. danni all'apparecchio o ad altri beni materiali. L'apparecchio è destinato solo all'uso regolamentare e va utilizzato solo in uno stato perfetto per quanto riguarda la tecnica della sicurezza.

Eventuali anomalie, che possono pregiudicare la sicurezza devono essere immediatamente eliminate.

3 Dati tecnici

Costruttore	Andreas Hettich GmbH & Co. KG D-78532 Tuttlingen			
Modello	UNIVERSAL 320		UNIVERSAL 320 R	
Tipo	1401	1401-01	1406	1406-01
Tensione di rete ($\pm 10\%$)	200-240 V 1~	100-127 V 1~	200-240 V 1~	240 V 1~
Frequenza di rete	50 – 60 Hz	50 – 60 Hz	50 Hz	60 Hz
Potenza assorbita	400 VA	400 VA	800 VA	950 VA
Assorbimento di corrente	2.0 A	4.0 A	4.0 A	8.0 A
Tipo di refrigerante	----		R 404A	
Capacità max.	4 x 200 ml			
Densità permessa	1.2 kg/dm ³			
Regime di rotazione (RPM)	16000			
Accelerazione (RCF)	24900			
Energia cinetica	9500 Nm			
Obbligo di collaudo (DGUV Regel 100 - 500)	no			
Presupposti ambientali (EN / IEC 61010-1)	<p>solo in interni fino a 2000 metri sopra il livello del mare</p> <p>2°C fino a 35°C 5°C fino a 35°C</p> <p>umidità relativa massima dell'aria 80% per temperature fino a 31°C, con riduzione lineare fino al 50% dell'umidità relativa per una temperatura di 40°C.</p>			
– luogo di installazione				
– altezza				
– temperatura ambiente				
– umidità dell'aria				
– Categoria di sovratensione (IEC 60364-4-443)	II			
– grado di imbrattamento	2			
Classe di protezione	I			
non adatto per l'impiego in ambiente a rischio di esplosione.				
Compatibilità elettromagnetica	EN / IEC 61326-1, classe B		EN / IEC 61326-1, classe B	
– emissione di radiointerferenze, resistenza alle interferenze	FCC Class B		FCC Class B	
Livello di emissione acustica (in funzione del rotore)	≤ 68 dB(A)		≤ 64 dB(A)	
dimensioni				
– larghezza	401 mm		407 mm	
– profondità	529 mm		698 mm	
– altezza	346 mm		346 mm	
Peso	ca. 31 kg		ca. 52 kg	

Costruttore	Andreas Hettich GmbH & Co. KG D-78532 Tuttlingen			
Modello	UNIVERSAL 320 R			
Tipo	1406-50	1406-51	1406-70	1406-71
Tensione di rete ($\pm 10\%$)	200-240 V 1~	100-127 V 1~	200-240 V 1~	100-127 V 1~
Frequenza di rete	50 – 60 Hz	50 – 60 Hz	50 – 60 Hz	50 – 60 Hz
Potenza assorbita	400 VA	400 VA	400 VA	400 VA
Assorbimento di corrente	2.0 A	4.0 A	2.0 A	4.0 A
Capacità max.	4 x 200 ml			
Densità permessa	1.2 kg/dm ³			
Regime di rotazione (RPM)	16000			
Accelerazione (RCF)	24900			
Energia cinetica	9500 Nm			
Obbligo di collaudo (DGUV Regel 100 - 500)	no			
Presupposti ambientali (EN / IEC 61010-1)	<p>solo in interni fino a 2000 metri sopra il livello del mare 2°C fino a 35°C umidità relativa massima dell'aria 80% per temperature fino a 31°C, con riduzione lineare fino al 50% dell'umidità relativa per una temperatura di 40°C.</p>			
– luogo di installazione				
– altezza				
– temperatura ambiente				
– umidità dell'aria				
– Categoria di sovratensione (IEC 60364-4-443)	II			
– grado di imbrattamento	2			
Classe di protezione	I			
non adatto per l'impiego in ambiente a rischio di esplosione.				
Compatibilità elettromagnetica				
– emissione di radiointerferenze, resistenza alle interferenze	EN / IEC 61326-1, classe B	FCC Class B	EN / IEC 61326-1, classe B	FCC Class B
Livello di emissione acustica (in funzione del rotore)	≤ 64 dB(A)			
dimensioni				
– larghezza	401 mm		401 mm	
– profondità	549 mm		550 mm	
– altezza	346 mm		365 mm	
Peso	ca. 35 kg			

Costruttore	Andreas Hettich GmbH & Co. KG D-78532 Tuttlingen		
Modello	UNIVERSAL 320 R		
Tipo	1406-20	1406-21	
Tensione di rete ($\pm 10\%$)	200-240 V 1~	240 V 1~	115-127 V 1~
Frequenza di rete	50 Hz	60 Hz	60 Hz
Potenza assorbita	800 VA		950VA
Assorbimento di corrente	4.0 A		8.0 A
Tipo di refrigerante	R 404A		
Capacità max.	4 x 200 ml		
Densità permessa	1.2 kg/dm ³		
Regime di rotazione (RPM)	16000		
Accelerazione (RCF)	24900		
Energia cinetica	9500 Nm		
Obbligo di collaudo (DGUV Regel 100 - 500)	no		
Presupposti ambientali (EN / IEC 61010-1)	<p>solo in interni fino a 2000 metri sopra il livello del mare 5°C fino a 35°C umidità relativa massima dell'aria 80% per temperature fino a 31°C, con riduzione lineare fino al 50% dell'umidità relativa per una temperatura di 40°C.</p>		
– luogo di installazione			
– altezza			
– temperatura ambiente			
– umidità dell'aria			
– Categoria di sovratensione (IEC 60364-4-443)	II		
– grado di imbrattamento	2		
Classe di protezione	I		
non adatto per l'impiego in ambiente a rischio di esplosione.			
Compatibilità elettromagnetica			
– emissione di radiointerferenze, resistenza alle interferenze	EN / IEC 61326-1, classe B	FCC Class B	
Livello di emissione acustica (in funzione del rotore)	≤ 64 dB(A)		
dimensioni			
– larghezza	407 mm		
– profondità	725 mm		
– altezza	365 mm		
Peso	ca. 52 kg		

4 Indicazioni inerenti la sicurezza



Se non vengono rispettate tutte le avvertenze riportate in queste istruzioni per il funzionamento, non può essere accettata da parte del costruttore alcuna richiesta di garanzia.



- La centrifuga deve venire posizionata in modo sicuro.
- Prima di utilizzare la centrifuga, è necessario controllare che il rotore sia correttamente in sede.
- Durante un'operazione di centrifugazione, in una zona di sicurezza di 300 mm attorno alla centrifuga non deve sostare alcuna persona, materiali pericolosi ed oggetti, in conformità alle norme EN / IEC 61010-2-020.
- I rotori, le sospensioni e gli accessori che presentano forti segni di corrosione o danni meccanici, oppure la cui durata d'impiego è scaduta, non devono più essere utilizzati.
- Se il vano di centrifugazione presenta danni rilevanti per la sicurezza, la centrifuga non deve essere più messa in funzione.
- In rotori oscillanti, i perni di trascinamento devono essere lubrificati regolarmente (Grasso lubrificante Hettich no. d'ord. 4051) per consentire un'oscillazione equilibrata dei ganci.
- Nel caso di centrifughe senza regolazione termica, con temperature ambiente elevate e/o con frequente impiego dell'apparecchiatura può presentarsi un riscaldamento del vano di centrifugazione. Per questo motivo non può venire esclusa una modificazione del materiale di prova a causa alla temperatura.

- Prima di mettere in funzione la centrifuga si devono leggere ed osservare le istruzioni per l'uso. L'apparecchio può essere utilizzato solo da persone che abbiano letto e compreso le istruzioni d'uso.
- Oltre alle istruzioni per l'uso, si devono osservare anche i regolamenti, relativi alla protezione antinfortunistica ed i regolamenti tecnici, riconosciuti in materia di sicurezza del lavoro. Le istruzioni per l'uso vanno completate dalle norme nazionali in vigore nel paese d'impiego, relative alla protezione antinfortunistica ed alla tutela ambientale.
- La centrifuga è costruita in base all'attuale livello tecnologico e le regole di sicurezza conosciute. La centrifuga può essere tuttavia fonte di pericolo per l'operatore o per terzi, se non viene utilizzata da personale appositamente addestrato o se viene utilizzata in modo improprio o non conforme alla destinazione.
- Durante l'esercizio bisogna evitare di muovere la centrifuga o di urtarvi contro.
- In caso di guasto, ovvero del ripristino d'emergenza, non si deve assolutamente toccare il rotore.
- Quando la centrifuga passa da un ambiente freddo in uno caldo, per evitare danni dovuti alla condensa, lasciar riscaldare la centrifuga per almeno 3 ore nell'ambiente caldo prima di collegarla alla rete, oppure portare la centrifuga a temperatura d'esercizio mettendola in funzione per 30 minuti nell'ambiente freddo.
- Devono essere utilizzati esclusivamente i rotori e gli accessori omologati per questa apparecchiatura (vedere capitolo "Anhang/Appendix, Rotoren und Zubehör/Rotors and accessories"). Prima di utilizzare contenitori di centrifugazione, che non sono elencati nel capitolo "Appendice/Appendix, Rotori ed accessori/Rotors and accessories", l'utente deve accertarsi presso il costruttore, che questi possano venire utilizzati.
- Il rotore della centrifuga può essere caricato solo in conformità al capitolo "Carico del rotore".
- In caso di centrifugazione con massimo numero di giri, la densità dei materiali o delle miscele di materiali non deve superare il valore di composizione di $1,2 \text{ kg/dm}^3$.
- Non è consentito l'uso di centrifughe non bilanciate in modo regolamentare.
- Non è permesso l'impiego della centrifuga in ambiente a pericolo di esplosione.
- E' proibito l'uso di una centrifuga con:
 - materiali infiammabili od esplosivi
 - materiali che possono reagire chimicamente tra loro con forte energia.

- Se vengono centrifugate sostanze pericolose o miscele di sostanze contaminate da microrganismi tossici, radioattivi o patogeni, l'utente dovrà prendere opportuni provvedimenti in materia.
È consentito esclusivamente l'impiego di contenitori di centrifugazione con speciali chiusure a vite per sostanze pericolose. Nel caso di materiali appartenenti al gruppo a rischio 3 e 4 oltre ai contenitori di centrifugazione è da utilizzare un sistema di biosicurezza (vedi manuale "Laboratory Bio-safety Manual" dell'Organizzazione mondiale per la salute).
Una ermetizzazione biologica (guarnizione ad anello) di questo sistema di biosicurezza impedisce la fuoriuscita delle goccioline e degli aerosol.
Se il gancio di un sistema di biosicurezza viene utilizzato senza il coperchio, la guarnizione ad anello deve venire tolta dal gancio, per evitare un danneggiamento della guarnizione ad anello durante il processo di centrifugazione. I sistemi di biosicurezza che sono danneggiati non sono più ermetici dal punto di vista microbiologico.
Senza l'impiego di un sistema di biosicurezza, una centrifuga non può essere considerata a tenuta ermetica dal punto di vista microbiologico ai sensi della norma EN / IEC 61010-2-020.
Per la chiusura di un sistema di biosicurezza sono da seguire le istruzioni al capitolo "Impiego dei sistemi di biosicurezza".
Per quanto riguarda i sistemi di biosicurezza fornibili, rimandiamo al capitolo "Appendice/Appendix, Rotori ed accessori/Rotors and accessories". Nel dubbio chiedere maggiori informazioni al produttore.
- Non è consentito il funzionamento della centrifuga con sostanze altamente corrosive che possono pregiudicare la resistenza meccanica dei rotor, delle sospensioni e degli accessori.
- Gli interventi di riparazione devono essere effettuati esclusivamente da una persona autorizzata dal costruttore.
- Devono essere impiegati solo ed esclusivamente pezzi di ricambio originali ed accessori autorizzati della ditta Andreas Hettich GmbH & Co. KG.
- Sono di validità le seguenti norme di sicurezza:
EN / IEC 61010-1 e EN / IEC 61010-2-020 come anche le loro nazionali varianti.
- La sicurezza e l'affidabilità della centrifuga sono garantite solo se:
 - la centrifuga funziona in conformità con le istruzioni per l'uso
 - l'installazione elettrica sul luogo di posizionamento della centrifuga risponde ai requisiti previsti dalla EN / IEC
 - i collaudi che riguardano la sicurezza dell'apparecchiatura e che sono prescritti nei diversi Stati, p.es. in Germania conformemente alla regolamentazione DGUV norma 3, vengono eseguiti da parte di un perito.

5 Significato dei simboli



Simbolo sull'apparecchio:

Attenzione, punto pericoloso generico.

Prima di utilizzare l'apparecchiatura leggere in ogni caso le istruzioni per l'uso ed osservare le istruzioni rilevanti per la sicurezza!



Simbolo in questo documento.

Attenzione, punto pericoloso generico.

Questo simbolo contraddistingue le avvertenze relative alla sicurezza e indica situazioni potenzialmente pericolose .

La mancata osservanza di tali avvertenze può causare danni materiali e personali.



Simbolo sull'apparecchiatura ed in questo documento:

Attenzione: rischio biologico.



Simbolo in questo documento:

Questo simbolo indica argomenti importanti.



Simbolo sull'apparecchiatura ed in questo documento:

Simbolo per la raccolta separata delle apparecchiature elettriche ed elettroniche, in conformità alle direttive 2002/96/CEE (WEEE). L'apparecchiatura appartiene al gruppo 8 (apparecchiature medicali).

Impiego nelle nazioni dell'Unione Europea, in Norvegia ed in Svizzera.

6 Contenuto della fornitura

- 1 cavo elettrico
- 1 chiave a forcella
- 1 grasso per perni portanti
- 1 istruzioni per l'uso
- 1 istruzioni per la sicurezza durante il trasporto

Rotore/i e i corrispondenti accessori vengono forniti in base alla commessa.

7 Disimballo della centrifuga

- Levare il cartone verso l'alto e togliere l'imbottitura.

•



Non sollevarla dalla copertura anteriore.

Considerare il peso della centrifuga, vedere capitolo "Dati tecnici".

Con il numero adeguato di persone, sollevare la centrifuga da entrambi i lati e riporla sul tavolo di laboratorio.

8 Messa in funzione

- Togliere la sicura per il trasporto, che si trova sul fondo dell'alloggiamento, vedere foglio avvisi "Sicura per il trasporto".
- Porre la centrifuga in un posto adatto e livellarla. Per l'installazione deve essere rispettata la zona di sicurezza di 300 mm attorno alla centrifuga, richiesta in conformità alle norme EN / IEC **61010-2-020**.



Durante un'operazione di centrifugazione, in una zona di sicurezza di 300 mm attorno alla centrifuga non deve sostare alcuna persona, materiali pericolosi ed oggetti, in conformità alle norme EN / IEC **61010-2-020**.

- Le aperture di ventilazione non devono essere chiuse mettendo oggetti davanti. Rispetto alle feritoie di ventilazione e ad alle aperture di ventilazione della centrifuga deve venir mantenuta una distanza di 300 mm.
- Con la centrifuga del tipo 1406-20, 1406-21, collegare l'alimentazione dell'azoto in conformità alla documentazione informativa AH1406-20XX allegata.
Con la centrifuga del tipo 1406-50, 1406-51, collegare il termostato per la ricircolazione basse temperature in conformità alla documentazione informativa AH1406-50XX allegata
Con la centrifuga del tipo 1406-70, 1406-71, collegare il termostato per la ricircolazione basse temperature e l'alimentazione dell'azoto in conformità alla documentazione informativa AH1406-70XX allegata.



Il collegamento della centrifuga deve avvenire assolutamente in conformità con la documentazione informativa allegata.

Prestate attenzione al foglio informativo allegato.

- Verificare se la tensione di rete sia adatta all'indicazione riportata nella targhetta con i dati caratteristici.
- Collegare la centrifuga ad una presa di rete standard utilizzando un cavo di rete. Per la potenza massima assorbita, vedere il capitolo "Dati tecnici".
- Accendere l'interruttore di rete. Posizione di accensione "I".
Il tipo di macchina e la versione di programma vengono indicati, i LED sono illuminati. Dopo 8 secondi viene visualizzato OPEN OEFFNEN e lampeggia il LED di sinistra nel tasto .
- Aprire il coperchio.
I dati di centrifuga utilizzati per ultimi vengono illustrati.

9 Apertura e chiusura del coperchio

9.1 Apertura del coperchio



E' possibile aprire il coperchio solo se la centrifuga è accesa ed il rotore è fermo.
Se non dovesse essere possibile, vedi capitolo "Sblocco di emergenza".

- Premere il tasto . Il coperchio si sblocca a motore e il LED sinistro nel tasto si spegne.

9.2 Chiusura del coperchio



Non afferrare con le dita tra il coperchio e il rivestimento.
Non chiudere il coperchio sbattendolo.

Quando lampeggia il LED di sinistra nel tasto , premere il tasto , in modo che il bloccaggio motorico del coperchio prenda la posizione di base (aperto).

- Posizionare il coperchio e spingere leggermente verso il basso il bordo anteriore del coperchio. La chiusura avviene grazie ad un sistema motorizzato. Si illumina il LED sinistro del tasto .

10 Montaggio e smontaggio del rotore

10.1 Rotore con dado di bloccaggio

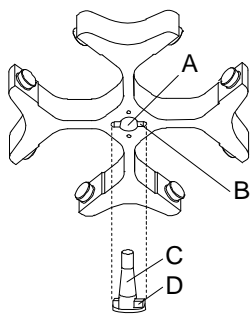

Montaggio del rotore:

 Le particelle di sporco tra l'albero motore ed il rotore impediscono un perfetto posizionamento in sede del rotore e sono causa di un irrequieto movimento.

- Pulire l'albero motore (C) ed il foro del rotore (A) ed ingrassare poi leggermente l'albero motore.
- Applicare verticalmente il rotore sull'albero motore. Il trascinatore dell'albero motore (D) deve trovarsi nella scanalatura del rotore (B). Sul rotore è contrassegnata la direzione della scanalatura.
- Serrare il dado di bloccaggio del rotore utilizzando la chiave che vi è stata fornita e serrando in senso orario.
- Controllare che il rotore sia fissato stabilmente.

Smontaggio del rotore:

- Sbloccare il dado di bloccaggio girandolo in senso antiorario e girare fino al punto di pressione di sollevamento. Dopo aver superato il punto di pressione di sollevamento il rotore si sblocca dal cono dell'albero motore.
- Girare il dado di bloccaggio, fino a quando il rotore si lascia sollevare dall'albero motore.

10.2 Rotore senza dado di bloccaggio

10.2.1 Montaggio e smontaggio del mozzo

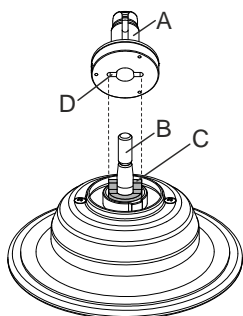

Montaggio del mozzo:

- Applicare verticalmente il mozzo (A) sull'albero motore (B). Il trascinatore (C) sull'albero motore deve trovarsi nella scanalatura (D) del mozzo.
- Serrare il dado di bloccaggio del mozzo utilizzando la chiave a brugola esagonale che vi è stata fornita e girando in senso orario.
- Controllare che il mozzo sia fissato stabilmente.

Smontaggio del mozzo:

- Estrarre il rotore.
- Sbloccare il dado di bloccaggio del mozzo girando in senso antiorario e girare fino al punto di pressione di sollevamento. Dopo aver superato il punto di pressione di sollevamento il mozzo si sblocca dal cono dell'albero motore.
- Girare il dado di bloccaggio, fino a quando il mozzo si lascia sollevare dall'albero motore.

10.2.2 Installazione ed estrazione del rotore

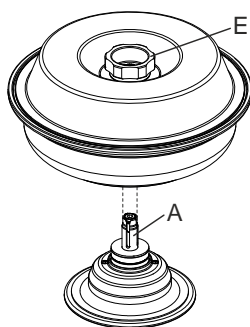

Installazione del rotore:

 Le particelle di sporco tra il mozzo ed il rotore impediscono un perfetto posizionamento in sede del rotore e sono causa di un irrequieto movimento. In caso di necessità prima di installare il rotore pulire il mozzo (A) sull'albero motore ed il mozzo del rotore.

- Sollevare il rotore tenendolo alla manopola (E) del coperchio, applicarlo in orizzontale sul mozzo (A) e premere verso il basso fino al fermo di arresto.

Estrazione del rotore:

- Trattenere il rotore tenendolo alla manopola (E) del coperchio e sollevare dal mozzo (A).

11 Carico del rotore



Lo standard dei recipienti di vetro centrifugati sono da caricare fino a RCF 4000 (DIN 58970 capoverso 2).

- Verificare che il rotore sia fissato.
- Nel caso di rotori oscillanti, tutti i siti del rotore devono essere muniti di ganci **uguali**. Particolari ganci sono contrassegnati con il numero del sito del rotore. Questi ganci devono essere applicati solo nel relativo sito del rotore.
Ganci contrassegnati con un numero di kit, p.es. S001/4, devono essere utilizzati esclusivamente in kit.
- I rotori ed i ganci devono essere caricati esclusivamente in modo simmetrico. I recipienti di centrifuga devono essere distribuiti uniformemente su tutti i posti del rotore. Per le combinazioni permesse vedere capitolo "Anhang/Appendix, Rotoren und Zubehör/Rotors and accessories".
In caso di rotori angolari devono essere caricati tutti i possibili siti del rotore, vedere il capitolo "Anhang/Appendix, Rotoren und Zubehör/Rotors and accessories".

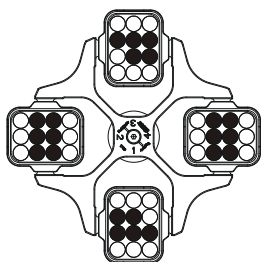

Il rotore è caricato uniformemente

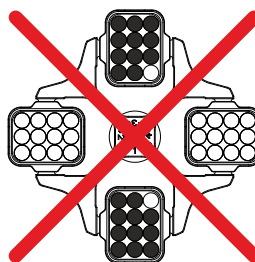

Non ammesso!

Il rotore è caricato in modo non uniforme

- Su certe sospensioni è indicato il peso del carico massimo oppure il peso del carico massimo e il peso massimo della sospensione completamente equipaggiata. Questi pesi non devono essere superati. In casi eccezionali vedere al capitolo "Centrifugazione di sostanze o di miscele di sostanze con densità maggiore di $1,2 \text{ kg/dm}^3$ ". Il peso indicato per il carico massimo comprende il peso completo di riduttore, supporto, provetta da centrifuga e contenuto.
- Nel caso di contenitori con inserimenti in gomma, deve essere sempre mantenuto lo stesso numero di inserimenti in gomma sotto i contenitori di centrifugazione.
- L'operazione di riempimento dei contenitori di centrifugazione è ammessa solo al di fuori della centrifuga.
- Il carico massimo dei recipienti della centrifuga non deve essere superiore a quello indicato dalla casa costruttrice.

Con rotori a squadra, il riempimento dei contenitori di centrifugazione è consentito solo fino al livello per cui, durante l'operazione di centrifugazione, non venga espulso alcun liquido dai contenitori.

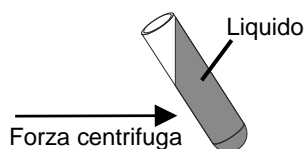

- Con il caricamento di rotori a squadra non deve pervenire alcun liquido nei rotori a squadra e nel vano di centrifugazione.
- Con il caricamento dei ganci dei rotori di smorzamento come anche con lo smorzamento dei ganci durante l'operazione di centrifuga non deve pervenire alcun liquido nei ganci e nel vano di centrifugazione.
- Per limitare al massimo le differenze di peso all'interno dei contenitori di centrifugazione, bisogna fare attenzione che siano riempiti tutti in modo uguale.

12 Applicare nel gancio l'adattatore con il perno di posizionamento

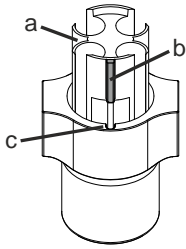

- Applicare l'adattatore (a) nel gancio in modo, che il perno di posizionamento (b) si trovi nella scanalatura (c) del gancio.



Se l'adattatore (a) non viene applicato in modo esatto, i contenitori di centrifugazione possono venir danneggiati durante il processo di centrifugazione.

13 Impiego dei sistemi di biosicurezza



L'impiego dei sistemi di biosicurezza è consentito solo in condizioni asciutte.

Prima di qualsiasi utilizzo del sistema di biosicurezza deve venir controllato visivamente il perfetto stato di tutti i suoi componenti. Deve venir controllata inoltre l'esatta posizione di installazione della guarnizione ad anello ovvero delle guarnizioni ad anello del sistema di biosicurezza.

I componenti danneggiati del sistema di biosicurezza devono venire immediatamente sostituiti.

I sistemi di biosicurezza che sono danneggiati non sono più ermetici dal punto di vista microbiologico.

Per garantire l'ermeticità, il coperchio di un sistema di biosicurezza deve venir chiuso in modo esatto.

Per quanto riguarda i sistemi di biosicurezza fornibili, rimandiamo al capitolo "Appendice/Appendix, Rotori ed accessori/Rotors and accessories". Nel dubbio chiedere maggiori informazioni al produttore.

13.1 Chiudere ed aprire il coperchio dei sistemi di biosicurezza

13.1.1 Coperchio con chiusura a vite e foro nella manopola

Chiudere il coperchio:

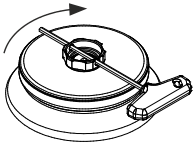

- Applicare il coperchio centralmente sul rotore.
- Inserire la chiave fornita attraverso il foro nella manopola e stringere ruotando il coperchio in senso orario.

Aprire il coperchio:

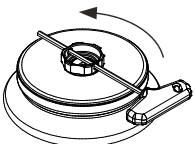

- Inserire attraverso il foro nella manopola la chiave che vi è stata fornita e girare in senso antiorario, fino a quando il coperchio si lascia togliere dal rotore.

13.1.2 Coperchio con chiusura a vite

Chiudere il coperchio:

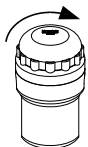

- Applicare il coperchio sul gancio.
- Chiudere con forza a mano il coperchio, girando in senso orario.

Aprire il coperchio:

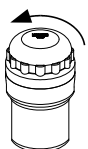

- Girare a mano il coperchio in senso antiorario, fino a quando il coperchio si lascia togliere dal gancio.

13.1.3 Coperchio con staffa e chiusura in bloccaggio a leva

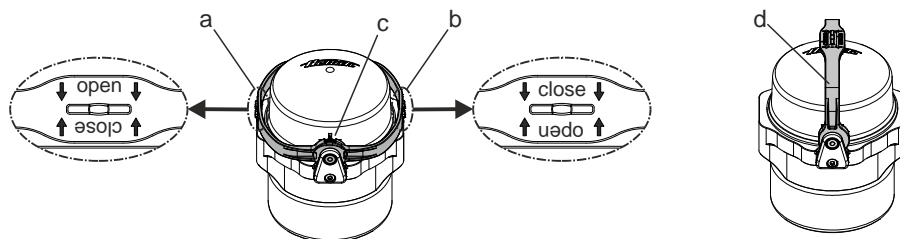

Chiudere il coperchio:

- Girare la staffa nella posizione "↓ open ↓" (a). Le frecce della dicitura ↓ open ↓" devono indicare verso il basso, in modo che il testo "open" sia leggibile.
- Applicare il coperchio sul gancio, in modo che entrambi i perni del coperchio si trovino nelle due aperture della staffa (c).
- Girare la staffa sul lato opposto del gancio, nella posizione "↓ close ↓" (b). Le frecce della dicitura ↓ close ↓" devono indicare verso il basso, in modo che il testo "close" sia leggibile.



La staffa deve essere adagiata sul gancio, in modo che i ganci possano smorzarsi durante il processo di centrifugazione.

- Girando la staffa nella posizione (d), il sistema di biosicurezza può venire trasportato tenendolo alla staffa.



L'ermeticità del sistema di biosicurezza è garantita anche nella posizione di trasporto.

Durante il suo trasporto il sistema di biosicurezza non deve venir fatto oscillare, perché altrimenti non viene più garantita la sua ermeticità.

- Per semplificare le operazioni di applicazione e di estrazione dei ganci, girare la staffa nella posizione (d) e trattenere i ganci tenendoli alla staffa.

Aprire il coperchio:

- Girare la staffa nella posizione "↓ open ↓" (a). Le frecce della dicitura ↓ open ↓" devono indicare verso il basso, in modo che il testo "open" sia leggibile.
- Prelevare il coperchio dal gancio.

13.2 Immagazzinaggio dei sistemi di biosicurezza

- Per evitare un danneggiamento delle guarnizioni ad anello durante l'immagazzinaggio, l'immagazzinaggio dei sistemi di biosicurezza è consentito solo con coperchio aperto.

14 Elementi di operazione e visualizzazione

Vedere illustrazione alla pagina 2

Fig. 2, Fig. 3: Display





14.1 Manopola



Per l'impostazione dei singoli parametri.

La rotazione in senso antiorario riduce il valore. La rotazione in senso orario aumenta il valore.

14.2 Tasti del display

- 
 - Tasto di selezione per selezionare i singoli parametri. Premendo successivamente questo tasto viene selezionato il parametro successivo.
- 
 - Avviare il ciclo di centrifuga. Il LED del tasto rimane acceso durante il ciclo di centrifuga, fintanto che il rotore gira.
 - Centrifuga breve. Il ciclo di centrifuga continua fintanto che viene premuto il tasto. Il LED del tasto rimane acceso per tutto il ciclo, fintanto che il rotore gira.
 - Salvare dati e modifiche.
- 
 - Terminare il ciclo di centrifuga. Il rotore si arresta con il livello di frenatura impostato. Il LED destro del tasto rimane acceso fintanto che il rotore non si arresta. Dopo l'arresto del rotore si illumina il LED sinistro del tasto. Premendo due volte il tasto si inserisce l'arresto d'emergenza.
 - Sbloccare il coperchio. Si spegne il LED sinistro del tasto.
 - Interrompere l'inserimento parametri.
- 
 - Commutare tra visualizzazione RPM e RCF. I valori RCF vengono visualizzati in > <.
- 
 - Avviare pre-riscaldamento. La velocità di pre-riscaldamento è regolabile. È preimpostata a 2800 giri/min.

14.3 Possibilità di regolazione

PROG RCL Posizione programma da richiamare.

t/min Durata ciclo. Impostabile da 0 - 99 min, ad intervalli di 1 min.

t/sec Durata ciclo. Impostabile da 0 - 59 sec., ad intervalli di 1 secondo .

Funzionamento continuo "∞". Azzerare i parametri **t/min** e **t/sec**.

RPM Numero di giri. È impostabile un valore numerico di 500 rpm fino al numero di giri massimo del rotore. Per il numero di giri massimo del rotore, vedi capitolo "Anhang/Appendix, Rotoren und Zubehör/Rotors and accessories". Impostabile ad intervalli di 10.

RAD/mm Raggio di centrifugazione. Inserimento in mm. Per il raggio di centrifugazione, vedere capitolo "Anhang/Appendix, Rotoren und Zubehör/Rotors and accessories". E' possibile digitare il raggio solo se viene selezionato l'indicatore RCF (> RCF <).

RCF Acceleramento relativo della centrifuga. È impostabile un valore numerico con il quale si ottiene un numero di giri compreso tra 500 rpm ed il numero di giri massimo del rotore. Regolabile fino a 100 in passi da 1 e da 100 in passi da 10 . Il valore RCF viene automaticamente arrotondato per eccesso o per difetto al passo del numero di giri. E' possibile digitare il RCF se viene selezionato l'indicatore RCF (> RCF <).

 Livelli di inizio 1 - 9. Livello 9 = tempo di avvio più breve, livello 1 = tempo di avvio più lungo

 Livelli di frenatura 0 - 9. Livello 9 = tempo di arresto più breve, livello 1 = tempo di arresto più lungo
Livello 0 = tempo di arresto più lungo (arresto non frenato).

T/°C Valore nominale di temperatura (solo per centrifuga con raffreddamento). Regolabile da -20°C fino a +40°C, in passi da 1°C. La temperatura minima raggiungibile dipende dal rotore (vedere capitolo "Anhang/Appendix, Rotoren und Zubehör/Rotors and accessories").

PROG STO Posizione in cui è memorizzato il programma. Si possono salvare 9 programmi (posizioni programmi 1 - 2 - 3 - ... 9). La posizione di memoria programma # funge da memoria transitoria per impostazioni modificate.

15 Inserire i parametri di centrifugazione

 Nel caso in cui, dopo aver selezionato oppure durante l'inserimento di parametri, non venga premuto per 8 secondi alcun tasto, vengono indicati i valori precedenti. L'inserimento dei parametri deve essere poi eseguita nuovamente.

- Selezionare con il tasto **[RCF]** le indicazioni RPM oppure RCF. I valori RCF vengono visualizzati in **> <**.
- Selezionare i parametri richiesti con il tasto **[SELECT]** ed impostarli con la manopola **○**. Per impostare il funzionamento continuo, i parametri **t/min** e **t/sec** devono essere azzerati con la manopola **○**. Il funzionamento continuo è indicato sul display dal simbolo "∞".
- Dopo l'inserimento di tutti i parametri, premere il tasto **[START/IMPULS]** per salvare gli inserimenti nella memoria di programma **#**. Per conferma, viene indicata per alcuni secondi la dicitura ***** ok *****.

 I dati sulla posizione di memoria programma **#** vengono soprascritti con ogni nuovo inserimento di parametri e premendo il tasto **[START/IMPULS]**.

16 Programmazione

16.1 Inserimento/Variazione del programma

 Nel caso in cui, dopo aver selezionato oppure durante l'inserimento di parametri, non venga premuto per 8 secondi alcun tasto, vengono indicati i valori precedenti. L'inserimento dei parametri deve essere poi eseguita nuovamente.

- Selezionare con il tasto **[RCF]** le indicazioni RPM oppure RCF. I valori RCF vengono visualizzati in **> <**.
- Selezionare i parametri richiesti con il tasto **[SELECT]** ed impostarli con la manopola **○**. Per impostare il funzionamento continuo, i parametri **t/min** e **t/sec** devono essere azzerati con la manopola **○**. Il funzionamento continuo è indicato sul display dal simbolo "∞".
- Selezionare il parametro **PROG STO** con il tasto **[SELECT]** ed impostare la posizione richiesta del programma con la manopola **○**.
- Premere il tasto **[START/IMPULS]** per salvare le impostazioni nel programma desiderato. A conferma viene visualizzato per breve tempo ***** ok *****.
Se viene premuto il tasto **[START/IMPULS]**, senza che sia stato selezionato il parametro **PROG STO**, le informazioni vengono memorizzate sempre sul posto di programma **#**.

 I precedenti dati del programma vengono soprascritti con il salvataggio.

16.2 Richiamo del programma

- Selezionare con il tasto **[SELECT]** il parametro **PROG RCL** ed impostare il programma desiderato con la manopola **○**.
- Premere il tasto **[START/IMPULS]**. Vengono visualizzati i dati di centrifuga del programma selezionato.
- E' possibile verificare i parametri premendo il tasto **[SELECT]**.
Per uscire dalla visualizzazione dei parametri, premere il tasto **[OPEN/STOP]** oppure non premere alcun tasto per 8 secondi.

17 Centrifugazione

 Durante un'operazione di centrifugazione, in una zona di sicurezza di 300 mm attorno alla centrifuga non deve sostare alcuna persona, materiali pericolosi ed oggetti, in conformità alle norme EN / IEC 61010-2-020.

 Nel caso in cui la differenza di peso permessa nel caricamento del rotore venga superata, si ferma l'azionamento durante l'avvio, si illumina l'indicazione di squilibrio e compare la dicitura **IMBALANCE**.
Una corsa di centrifugazione può essere interrotta in ogni momento premendo il tasto **[OPEN/STOP]**.
Durante la corsa di centrifugazione, può essere selezionato e modificato ogni tipo di parametro (vedere capitolo "Inserire i parametri di centrifugazione").
Con il tasto **[RCF]** è possibile commutare in ogni momento le indicazioni RPM e RCF. Se viene usata l'indicazione RCF, è necessario inserire il raggio di centrifugazione.
Se compaiono le diciture **◀ OPEN ▶ OEFFNEN (=APRIRE)**, è possibile un'operazione della centrifuga solo dopo aver aperto una volta il coperchio.
Se viene visualizzato **R xx n-max xxxxx**, non ha avuto luogo alcun processo di centrifugazione in quanto è stato sostituito il rotore, vedere il capitolo "Riconoscimento del rotore".

- Accendere l'interruttore di rete. Posizione di accensione **I**.
- Caricare il rotore e chiudere il coperchio della centrifuga.

17.1 Centrifugazione con tempo preimpostato

- Selezionare il tempo oppure richiamare un programma con tempo preimpostato (vedere capitolo "Programmazione").
- Premere il tasto **START/IMPULS**. Il LED del tasto **START/IMPULS** rimane acceso fintanto che il rotore gira.
- Passato il tempo o con l'interruzione della corsa di centrifugazione premendo il tasto **OPEN/STOP**, avviene l'arresto con il livello di frenatura selezionato. Il livello di frenatura viene indicato..

Durante la corsa di centrifugazione compaiono il numero di giri del rotore, il valore RCF risultante, la temperatura delle provette (solo per centrifuga con raffreddamento) ed il tempo rimanente.

17.2 Corsa continua

- Impostazione il simbolo ∞ oppure richiamare il programma di corsa continua (vedere capitolo "Programmazione").
- Premere il tasto **START/IMPULS**. Il LED del tasto **START/IMPULS** rimane acceso fintanto che il rotore gira. Il conteggio del tempo inizia da 00:00.
- Premere il tasto **OPEN/STOP** per terminare la centrifugazione. L'arresto avviene con il livello di frenatura selezionato. Il livello di frenatura viene indicato.

Durante la centrifugazione compaiono il numero di giri del rotore, il valore RCF risultante, la temperatura delle provette (solo per centrifuga con raffreddamento) ed il tempo intercorso.

17.3 Centrifugazione breve

- Tenere premuto il tasto **START/IMPULS**. Il LED del tasto **START/IMPULS** rimane acceso fintanto che il rotore gira. Il conteggio del tempo inizia da 00:00.
- Togliere il dito dal tasto **START/IMPULS** per terminare la corsa di centrifugazione. L'arresto avviene con il livello di frenatura selezionato. Il livello di frenatura viene indicato.

Durante la centrifugazione compaiono il numero di giri del rotore, il valore RCF risultante, la temperatura delle provette (solo per centrifuga con raffreddamento) ed il tempo rimanente.

18 Arresto di emergenza

- Premere 2 volte il tasto **OPEN/STOP**

Con l'arresto di emergenza l'arresto avviene con il livello di frenatura 9 (arresto più breve). Il livello di frenatura 9 viene indicato.

Con il livello di frenatura preimpostato sullo 0, il tempo di arresto, per motivi tecnici, è superiore a quello raggiunto con il livello di frenatura 9.

19 Segnale acustico

Il segnale acustico si attiva quando:

- con il verificarsi di un guasto con intervallo di 2 sec
- dopo il terminare della corsa di centrifugazione e arresto del rotore con intervallo di 30 secondi

Aperto il coperchio oppure premendo un tasto qualsiasi, il segnale acustico cessa.

Il segnale che si attiva in seguito alla cessazione della corsa di centrifugazione, può essere attivato o disattivato, raggiunto l'arresto del rotore, in modo seguente:

- Tenere premuto il tasto **SELECT** per 8 secondi.
Dopo 8 sec. compare la dicitura **SOUND / BELL**.
- Impostare OFF (disinserito) o ON (inserito) con la manopola.
- Premere il tasto **START/IMPULS** per salvare le impostazioni. Per conferma, compare per alcuni secondi la dicitura ***** ok *****.

20 Consultazione delle ore di funzionamento

La consultazione delle ore di funzionamento è possibile solo con rotore in posizione di arresto.

- Tenere premuto il tasto **SELECT** per 8 secondi.
Dopo 8 sec. Compare la dicitura **SOUND / BELL**.
- Premere nuovamente il tasto **SELECT**
Compaiono le ore di funzionamento della centrifuga (CONTROL:).
- Per uscire dalla richiesta delle ore di funzionamento premere il tasto **OPEN/STOP**.

21 Raffreddamento (solo per centrifuga con raffreddamento)

Il valore nominale di temperatura può essere selezionata da -20°C fino a +40°C. La temperatura minima raggiungibile dipende dal rotore (vedere capitolo "Anhang/Appendix, Rotoren und Zubehör/Rotors and accessories").

21.1 Raffreddamento-Standby

Con l'arresto del rotore e coperchio chiuso, la camera di centrifugazione viene raffreddata alla temperatura selezionata. Nel display compare il valore nominale di temperatura.

Dopo un procedimento di centrifugazione, il raffreddamento-Standby avviene con un ritardo di tempo, e nel display compare **OPEN / OEFFNEN (aprire)**. Il ritardo di tempo è da 1 fino a 5 minuti, regolabile in passi di 1 minuto. Il ritardo è impostato di standard sul valore di 1 minuto.

A rotore fermo e coperchio aperto, il ritardo di tempo può essere impostato come segue.

- Tenere premuto il tasto **⏏** per 8 secondi.
Dopo 8 secondi Compare la dicitura **t/min = X**.
- Impostare il ritardo di tempo con la manopola **⊖**.
- Premere il tasto **START/IMPULS** per salvare le impostazioni. Per conferma, compare per alcuni secondi la dicitura ***** ok *****.

Per abbandonare l'indicazione del ritardo tempo premere il tasto **OPEN/STOP** o non premere alcun tasto per il tempo di 8 secondi.

21.2 Pre-raffreddamento del rotore

- Premere il tasto **⏏**. Il LED del tasto **START/IMPULS** rimane acceso fintanto che il rotore gira.
- Premere il tasto **OPEN/STOP** per terminare il pre-raffreddamento. L'arresto avviene con il livello di frenatura selezionato. Il livello di frenatura viene indicato.

Durante la centrifugazione compaiono il numero di giri del rotore, il valore RCF risultante, la temperatura delle provette ed il tempo intercorso.

La velocità di pre-raffreddamento è di 500 RPM (giri/min) ed è regolabile in passi da 10 fino al valore massimo del regime di rotazione del rotore. È preimpostata a 2800 giri/min.

A rotore fermo e a coperchio aperto è possibile impostare la velocità di pre-raffreddamento nel seguente modo:

- Tenere premuto il tasto **⏏** per 8 secondi.
Dopo 8 secondi Compare la dicitura **t/min = X**.
- Premere nuovamente il tasto **⏏**.
La velocità di pre-raffreddamento impostata **RPM = XXXX** viene indicata.
- Impostare la velocità di pre-raffreddamento desiderata con la manopola **⊖**.
- Premere il tasto **START/IMPULS** per salvare le impostazioni. Per conferma, compare per alcuni secondi la dicitura ***** ok *****.

Per abbandonare l'indicazione della velocità di pre-raffreddamento premere il tasto **OPEN/STOP** o non premere alcun tasto per il tempo di 8 secondi.

22 Accelerazione centrifuga relativa (RCF)

L'accelerazione centrifuga relativa (RCF) è indicata come un multiplo dell'accelerazione terrestre (g). È un valore numerico privo di unità e funge per paragonare le prestazioni di separazione e sedimentazione.

Il calcolo viene eseguito in base alla formula:

$$RCF = \left(\frac{RPM}{1000} \right)^2 \times r \times 1,118 \quad \Rightarrow \quad RPM = \sqrt{\frac{RCF}{r \times 1,118}} \times 1000$$

RCF = accelerazione centrifuga relativa

RPM = numero dei giri

r = raggio di centrifugazione in mm = distanza dal centro dell'asse di rotazione fino al fondo del recipiente di centrifugazione. Raggio di centrifugazione vedi al capitolo "Anhang/Appendix, Rotoren und Zubehör/Rotors and accessories".



L'accelerazione centrifuga relativa (RCF) dipende dal numero dei giri e dal raggio di centrifugazione.

23 Centrifugazione di sostanze o di miscele di sostanze con densità maggiore di 1,2 kg/dm³

In caso di centrifugazione con massimo numero di giri, la densità dei materiali o delle miscele di materiali non deve superare il valore di composizione di 1,2 kg/dm³.

Con sostanze o miscele di sostanze di densità maggiore, il regime di rotazione deve venire ridotto.

Il numero di giri consentito si calcola con la formula seguente:

$$\text{numero di giri ridotto (n}_{\text{red}}) = \sqrt{\frac{1,2}{\text{densità maggiore [kg/dm}^3]}} \times \text{regime massimo di rotazione [RPM]}$$

p.es.: regime massimo di rotazione RPM 4000, densità 1,6 kg/dm³

$$n_{\text{red}} = \sqrt{\frac{1,2 \text{ kg/dm}^3}{1,6 \text{ kg/dm}^3}} \times 4000 \text{ RPM} = 3464 \text{ RPM}$$

Se in casi eccezionali viene superato il carico massimo indicato sul gancio, il regime di rotazione deve essere ridotto.

Il numero di giri consentito si calcola con la formula seguente:

$$\text{numero di giri ridotto (n}_{\text{red}}) = \sqrt{\frac{\text{carico massimo [g]}}{\text{carico effettivo [g]}}} \times \text{regime massimo di rotazione [RPM]}$$

p.es.: regime massimo di rotazione RPM 4000, carico massimo 350 g, carico effettivo 300 g

$$n_{\text{red}} = \sqrt{\frac{300 \text{ g}}{350 \text{ g}}} \times 4000 \text{ RPM} = 3703 \text{ RPM}$$

In caso di dubbio, rivolgersi al costruttore per maggiori informazioni.

24 Riconoscimento del rotore

Con l'inizio di ogni corsa di centrifugazione avviene il riconoscimento del rotore installato.

Dopo una sostituzione del rotore, il ciclo di centrifugazione si interrompe dopo il riconoscimento del rotore. Vengono visualizzati il Rotorcode (R xx) e il numero di giri massimo (n-max=xxxxx) del rotore.



L'ulteriore utilizzo della centrifuga è possibile solo dopo avere aperto una volta il coperchio.

Se il numero di giri massimo del rotore utilizzato è inferiore al numero di giri impostato, la velocità viene limitata al numero di giri massimo del rotore.

25 Sblocco di emergenza

In caso di una caduta di tensione, il coperchio non può essere sbloccato a motore. Deve essere effettuata manualmente uno sblocco di emergenza.



Per lo sblocco di emergenza, disconnettere la centrifuga dalla rete elettrica.
Aprire il coperchio solo con l'arresto del rotore.

Vedere illustrazione alla pagina 2.

- Disinserire l'interruttore di rete (posizione interruttore "0").
- Guardare attraverso la finestra presente nel coperchio per assicurarsi che il rotore sia fermo.
- Introdurre la chiave per viti Allen nel foro (Fig. 1, A) e ruotarla con cautela di mezzo giro in senso orario, fino ad aprire il coperchio.
- Strappare la vita senza testa esagonale dal foro.
- Quando dopo il reinserimento della centrifuga lampeggia il LED di sinistra nel tasto **OPEN/STOP**, premere il tasto **OPEN/STOP** in modo che il bloccaggio motorico del coperchio prenda la posizione di base (aperto).

26 Pulizia e manutenzione



L'apparecchiatura può essere contaminata.



Prima della pulizia, staccare la presa di corrente.

Prima di iniziare un procedimento di pulizia e decontaminazione diverso da quello consigliato dal produttore, l'utilizzatore deve accertarsi presso il produttore che tale procedimento previsto non rechi danno all'apparecchio.

- Centrifughe, rotor e accessori non devono essere lavati in lavastoviglie.
- Si deve eseguire solo una pulizia manuale ed una disinfezione con liquido.
- La temperatura dell'acqua deve essere di 20 – 25°C.
- Devono essere utilizzati solo detersivi o disinfettanti che:
 - abbiano un campo di valori del pH che va da 5 a 8,
 - non contengano alcali caustici, perossidi, composti di cloro, acidi e soluzioni alcaline.
- Seguire attentamente le indicazioni speciali del produttore sull'impiego di detersivi e disinfettanti, al fine di evitare qualsiasi fenomeno di corrosione.

26.1 Centrifughe (scatola, coperchio e vano di centrifugazione)

26.1.1 Cura e pulizia delle superfici

- Pulire regolarmente il corpo della centrifuga e la camera di centrifugazione e impiegare all'occorrenza sapone o un detersivo delicato e un panno umido. Ciò serve da un lato per l'igiene e dall'altro lato per evitare la corrosione causata da impurità incrostate.
- Ingredienti dei detersivi adatti:
sapone, tensidi anionici, tensidi non ionici.
- Dopo l'impiego di detersivi, rimuovere i resti del detersivo pulendo di nuovo con un panno umido.
- Le superfici devono essere asciugate subito dopo la pulizia.
- In caso di formazione di acqua di condensa, asciugare la camera di centrifugazione pulendola con un panno assorbente.
- Spalmare sulla guarnizione di gomma della camera di centrifugazione, frizionando leggermente, polvere di talco o una sostanza per la cura della gomma.
- Controllare una volta l'anno se il vano di centrifugazione presenta danneggiamenti.



Se vengono stabiliti danni rilevanti per la sicurezza, la centrifuga non deve essere più messa in funzione. In questo caso si deve contattare il servizio assistenza clienti.

26.1.2 Disinfezione delle superfici

- In presenza di materiale infettivo nella camera di centrifugazione si deve disinfettarla immediatamente.
- Ingredienti dei disinfettanti adatti:
etanolo, alcol n proclitico, etilexanolo, tensidi anionici, inibitori di corrosione.
- Dopo l'impiego di disinfettanti, rimuovere i resti del disinfettante pulendo di nuovo con un panno umido.
- Le superfici devono essere asciugate subito dopo la disinfezione.

26.1.3 Rimuovere contaminazioni radioattive

- La sostanza deve essere certificata in modo speciale per rimuovere contaminazioni radioattive.
- Ingredienti di sostanze adatte alla rimozione di contaminazioni radioattive:
tensidi anionici, tensidi non ionici, etanolo poliidrato.
- Dopo aver rimosso le contaminazioni radioattive, rimuovere i resti della sostanza pulendo di nuovo con un panno umido.
- Le superfici devono essere asciugate, subito dopo la rimozione delle contaminazioni radioattive.

26.2 Rotori ed accessori

26.2.1 Pulizia e cura

- Per prevenire corrosione e alterazioni dei materiali, i rotor e l'accessorio devono essere regolarmente puliti con sapone o con un detergente delicato e con un panno umido. Si consiglia la pulizia almeno una volta la settimana. La sporcizia deve essere subito rimossa.
- Ingredienti dei detergenti adatti:
sapone, tensidi anionici, tensidi non ionici.
- Dopo l'impiego di detergenti, rimuovere i resti del detergente, risciacquando con acqua (solo al di fuori della centrifuga) o ripulendo con un panno umido.
- I rotor e gli accessori devono essere asciugati immediatamente dopo la pulizia.
- I rotor ad angolo, i contenitori e i supporti in alluminio devono essere ingrassati leggermente con grasso privo d'acidi come ad esempio vaselina quando sono ben asciutti.
- Le guarnizioni ad anello dei sistemi di biosicurezza sono da pulire settimanalmente.
Le guarnizioni ad anello sono realizzate in silicone. Per garantire l'ermeticità dei sistemi di biosicurezza, dopo la pulizia od il trattamento in autoclave non è consentito il trattamento delle guarnizioni ad anello con polvere di talco.

Prima di qualsiasi utilizzo del sistema di biosicurezza deve venir controllato il perfetto stato di tutti i suoi componenti. Deve venir controllata inoltre l'esatta posizione di installazione della guarnizione ad anello ovvero delle guarnizioni ad anello del sistema di biosicurezza.

I componenti danneggiati del sistema di biosicurezza devono venire immediatamente sostituiti.

In presenza di incrinature, infragilimento od usura la guarnizione ad anello interessata deve venir sostituita immediatamente. Nel caso di coperchi con guarnizioni ad anello non sostituibili deve venir sostituito l'intero coperchio.

Per quanto riguarda i sistemi di biosicurezza fornibili, rimandiamo al capitolo "Appendice/Appendix, Rotori ed accessori/Rotors and accessories".

- Per evitare la corrosione causata dall'umidità tra il rotore e l'albero motore, si deve provvedere almeno una volta al mese di smontare il rotore, pulirlo e di lubrificare leggermente l'albero motore.
- I rotor e gli elementi accessori devono essere verificati settimanalmente per quanto riguarda il loro stato di usura ed i danneggiamenti da corrosione.

Con i motori di smorzamento devono essere verificati soprattutto il settore dei perni di supporto e per i ganci le scanalature, verificare inoltre l'eventuale presenza di incrinature nel fondo.

Esempio: Incrinatura nel settore della scanalatura.

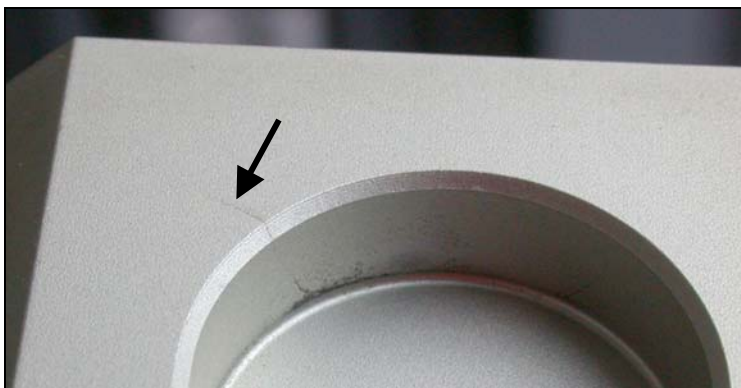

Rotori ed accessori non devono essere più utilizzati se presentano consumo o corrosione.

- Verificare settimanalmente la posizione del rotore.

26.2.2 Disinfezione

- Se del materiale infetto viene a contatto con i rotor o con gli accessori, allora si deve eseguire una disinfezione adeguata.
- Ingredienti dei disinfettanti adatti:
etanolo, alcol n proclitico, etilexanolo, tensidi anionici, inibitori di corrosione.
- Dopo l'impiego di disinfettanti, rimuovere i resti del disinfettante, risciacquando con acqua (solo al di fuori della centrifuga) o ripulendo con un panno umido.
- I rotor e gli accessori devono essere asciugati immediatamente dopo la disinfezione.

26.2.3 Rimuovere contaminazioni radioattive

- La sostanza deve essere certificata in special modo per rimuovere contaminazioni radioattive.
- Ingredienti di sostanze adatte alla rimozione di contaminazioni radioattive: tensidi anionici, tensidi non ionici, etanolo poliidrato.
- Dopo la rimozione delle contaminazioni radioattive, rimuovere la sostanza, risciacquando con acqua (solo al di fuori della centrifuga) o ripulendo con un panno umido.
- I rotori e gli accessori devono essere asciugati subito dopo la rimozione delle contaminazioni radioattive.

26.2.4 Perni di trascinamento

In rotori oscillanti, i perni di trascinamento devono essere lubrificati regolarmente (Grasso lubrificante Hettich no. d'ord. 4051) per consentire un'oscillazione equilibrata dei ganci.

26.2.5 Rotori ed accessori con limitata durata di impiego

L'impiego di particolari rotori, ganci ed elementi accessori è limitato nel tempo.

Questi sono contrassegnati con la quantità max. di cicli di funzionamento o dalla data di scadenza ed il numero massimo di cicli di funzionamento o solo con la data di scadenza, p.es.:

- "einsetzbar bis Ende: IV. Quartal 2011 / usable until end of: IV. trimestre 2011" (utilizzabile fino alla fine: IV. trimestre 2011) o "einsetzbar bis Ende Monat/Jahr: 10/2011 / usable until end of month/year: 10/2011" (utilizzabile fino a fine mese/anno: 10/2011)
- "max. Laufzyklen / max. cycles: 40000". (Max. funzionamento cicli)



Per motivi di sicurezza l'impiego dei rotori, dei ganci e degli elementi di accessorio non è più ammesso, quando è raggiunta la quantità massima permessa dei cicli di funzionamento che è sopracontrassegnata o quando è raggiunta la data di scadenza sopracontrassegnata.

26.3 Trattamento in autoclave

I seguenti accessori possono essere trattati in autoclave a 121°C / 250°F (20 min).

- Rotori di smorzamento
- Rotori a squadra in alluminio
- Gancio in metallo
- Coperchio con ermetizzazione biologica
- Adattatore

Per quanto riguarda il grado di sterilizzazione non può essere citato alcun dato.



I coperchi dei rotori ed i serbatoi devono venir tolti prima del trattamento in autoclave.

Il trattamento in autoclave accelera il processo di invecchiamento delle plastiche. Oltre a ciò può provocare il cambiamento di colorazione delle plastiche.

Il trattamento in autoclave del coperchio dei rotori 1515 e 1515-A è consentito solo per 10 volte. Per motivi di sicurezza deve venire poi sostituito.

Dopo il trattamento in autoclave deve venir controllata visivamente l'eventuale presenza di danneggiamenti ai rotori ed agli accessori ed i componenti eventualmente danneggiati devono essere immediatamente sostituiti.

In presenza di incrinature, infragilimento od usura la guarnizione ad anello interessata deve venir sostituita immediatamente.

Nel caso di coperchi con guarnizioni ad anello non sostituibili deve venir sostituito l'intero coperchio.

Per garantire l'ermeticità dei sistemi di biosicurezza, dopo il trattamento in autoclave non è consentito il trattamento delle guarnizioni ad anello con polvere di talco.

26.4 Contenitori centrifuga

- In caso di mancanza di tenuta o dopo la rottura dei contenitori per centrifugazione, rimuovere completamente i frammenti dei contenitori, le schegge di vetro e il centrifugato fuoriuscito.
- Dopo la rottura di parti in vetro, sostituire gli inserti di gomma e i manicotti di plastica dei rotori.



Le schegge di vetro rimaste causano ulteriori rotture!



- Nel caso di materiale infettivo, bisogna provvedere immediatamente ad una disinfezione.

27 Guasti

Se non si riesce a eliminare l'errore seguendo le indicazioni della tabella guasti, informare il servizio assistenza clienti.

Si prega di indicare il tipo di centrifuga e il numero di serie. Entrambi i numeri sono visibili sulla targhetta di modello della centrifuga.

	<p>Esecuzione di un RESET RETE:</p> <ul style="list-style-type: none"> - Disinserire l'interruttore di rete (posizione interruttore "0"). - Attendere almeno 10 secondi quindi reinserire l'interruttore di rete (posizione interruttore "1").
---	--

Visualizzazione/guasto		Causa	Eliminazione
Nessuna visualizzazione	---	Non c'è tensione. Scatto fusibile sovraccorrente	<ul style="list-style-type: none"> - Controllare alimentatore elettrico. - Interruttore di rete ON.
TACHO - ERROR	1, 2, 96	Tachimetro difettoso. Motore, sistema elettronico difettoso.	<ul style="list-style-type: none"> - Aprire il coperchio. - Disinserire l'interruttore di rete (posizione interruttore "0"). - Attendere per almeno 10 secondi. - Girare energicamente a mano il rotore. - Reinserrire l'interruttore di rete (posizione interruttore "1"). Durante l'inserimento il rotore deve girare.
CONTROL - ERROR	8	Errore blocco coperchio, ovvero chiusura coperchio.	
IMBALANCE	---	Il rotore è caricato in modo non uniforme.	<ul style="list-style-type: none"> - Aprire il coperchio. - Controllare il caricamento del rotore, vedere il capitolo "Carico del rotore". - Ripetere il ciclo di centrifugazione.
CONTROL - ERROR	4, 6	Errore blocco coperchio, ovvero chiusura coperchio.	<ul style="list-style-type: none"> - Esecuzione di un RESET RETE.
N > MAX	5	N° giri eccedente	
N < MIN	13	N° giri insufficiente	
MAINS INTERRUPT	---	Interruzione di rete durante il ciclo di centrifugazione. (Il ciclo di centrifugazione non viene terminato.)	<ul style="list-style-type: none"> - Aprire il coperchio. - Premere tasto . - All'occorrenza ripetere il ciclo di centrifugazione.
ROTORCODE	10.1, 10.2	Errore codifica rotore	<ul style="list-style-type: none"> - Aprire il coperchio.
CONTROL-ERROR	21, 22, 25, 27, 29	Guasto/difetto sistema elettronico.	<ul style="list-style-type: none"> - Esecuzione di un RESET RETE.
CONTROL-ERROR	23	Guasto/difetto parte comando.	
SER I/O - ERROR	30, 31, 33, 36	Guasto/difetto sistema elettronico.	
° C * - ERROR	51 - 53, 55	Guasto/difetto sistema elettronico.	
FU / CCI - ERROR	60 - 64, 67, 68, 82 - 86	Guasto/difetto sistema elettronico/motore.	
SYNC-ERROR	90	Guasto/difetto sistema elettronico.	
SENSOR-ERROR	91 - 93	Guasto/difetto sensore squilibrio.	
KEYBOARD-ERROR	---	Guasto/difetto parte comando.	<ul style="list-style-type: none"> - Aprire il coperchio. - Installare il rotore.
NO ROTOR	---	Non è installato alcun rotore	
N > ROTOR MAX	---	Il numero di giri nel programma selezionato è superiore al numero di giri massimo del rotore.	<ul style="list-style-type: none"> - Verificare e correggere la velocità nel programma selezionato.
		Il rotore è stato cambiato. Il rotore installato ha un numero di giri superiore del precedente e non è stato ancora riconosciuto.	<ul style="list-style-type: none"> - Impostare un numero di giri massimo superiore a quello del rotore precedentemente utilizzato. Premere il tasto  per effettuare il riconoscimento del rotore, vedi capitolo "Riconoscimento del rotore".

28 Rispedizione di apparecchi



Prima di rispedire un apparecchio deve essere montata la protezione per il trasporto.

Se l'apparecchio o uno dei suoi accessori viene rispedito alla ditta Andreas Hettich GmbH & Co. KG, esso deve essere prima decontaminato e pulito per la tutela di persone, ambiente e materiale.

Ci riserviamo la facoltà di accettare apparecchi o accessori contaminati.

Eventuali costi di pulizia e disinfezione verranno fatturati al cliente.

Contiamo a questo riguardo sulla vostra comprensione.

29 Smaltimento

Prima dello smaltimento, l'apparecchiatura deve essere decontaminata e pulita con lo scopo di proteggere le persone, l'ambiente e il materiale.

Per lo smaltimento dell'apparecchio osservare le rispettive norme di legge.

Ai sensi della direttiva 2002/96/CE (RAEE) tutti gli apparecchi forniti dopo il 13/08/2005 non possono più essere smaltiti con i rifiuti domestici. Questo apparecchio appartiene alla categoria 8 (Dispositivi medicali) ed è classificato nel settore Business-to-Business.











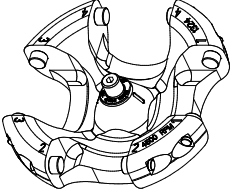

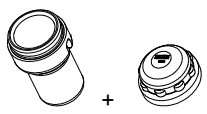





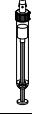

Il simbolo della pattumiera cancellata con una croce indica che l'apparecchio non deve essere smaltito con i rifiuti domestici.

Le norme per lo smaltimento possono essere differenti nei singoli paesi UE. In caso di necessità rivolgersi al proprio rivenditore.

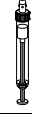







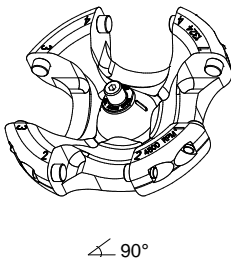
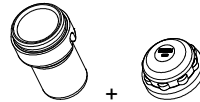

30 Anhang / Appendix









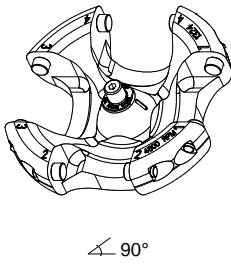
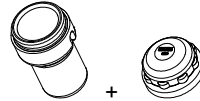

30.1 Rotoren und Zubehör / Rotors and accessories

1324		1490 + 1492							
Ausschwingrotor 4-fach / Swing out rotor 4-times  		 mit Bioabdichtung / with bio-containment ⁵⁾							
		0765		1329				1330	1331
									
0534 ⁴⁾	0535	0500	0507	0518			0519	0521	
									
Kapazität / capacity	ml	30		9	15	9 - 10	10	25	50
Maße / dimensions	Ø x L	44 x 105		14 x 100	17 x 100	16 x 92	15 x 102	24 x 100	34 x 100
Anzahl p. Rotor / number p. rotor		4		16	16	16	16	4	4
Drehzahl / speed	RPM	4500		4500	4500	4500	4500	4500	4500
RZB / RCF	³⁾	3170		3170	3170	3170	3328	3034	3011
Radius / radius	mm	140		140	140	140	147	134	133
 9 (97%)	sec					27			
 9	sec					30			
Temperatur / temperature	°C ¹⁾					- 6			
Probenerwärmung/Sample temp. rise	K ²⁾					10			

- 1) Tiefste erreichbare Temperatur bei maximaler Drehzahl, 1 h Laufzeit und 20°C Raumtemperatur (nur bei Kühlzentrifuge)
- 2) Probenerwärmung bei maximaler Drehzahl und 1 Stunde Laufzeit (nur bei Zentrifuge ohne Kühlung)
- 3) Zentrifugiergefäße aus Glas nur belastbar bis RZB 4000
- 4) nicht mit Stopfen zentrifugierbar, Skal. 10µl-300µl, 15ml, 30ml
- 5) Nach DIN EN 61010, Teil 2 – 020. Die Hinweise für Bio-Sicherheitssysteme in den Kapiteln "Sicherheitshinweise" und "Pflege und Wartung" beachten
- 6) Die Einlagen entfernen











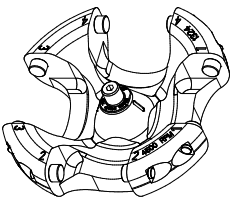

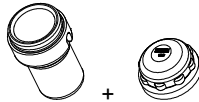
- 1) Lowest possible temperature during maximum speed, 1 h running time and 20°C ambient temperature (only with cooling centrifuges)
- 2) Sample temp. rise during maximum speed and 1 hour running time (only with centrifuges without cooling)
- 3) Centrifuge containers of glass will not stand RCF values exceeding 4000
- 4) can not be centrifugated when plug is attached, Scal. 10µl-300µl, 15ml, 30ml
- 5) in conformity with DIN EN 61010, part 2 – 020. Observe the notes for bio safety systems in chapters "Notes on safety" and "Maintenance and servicing".
- 6) Remove the inserts











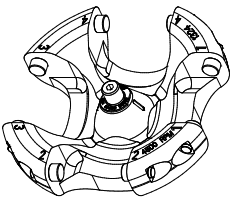

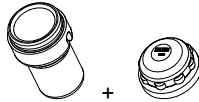





1324		1490 + 1492								
Ausschwingrotor 4-fach / Swing out rotor 4-times  90°		 mit Bioabdichtung / with bio-containment 5)								
		1339	1343	1347	1348					
		Rhesus			0509					
										
Kapazität / capacity	ml	1	3	4	15	10	8	4 – 4,5	4 - 7	
Maße / dimensions	∅ x L	mm	6 x 45	10 x 60	10 x 88	17 x 120	16 x 80	16 x 81	15 x 75	16 x 75
Anzahl p. Rotor / number p. rotor		108	36	36	4	16	16	16	16	
Drehzahl / speed	RPM	4500	4500	4500	4500	4500	4500	4500	4500	
RZB / RCF	³⁾	3237	3283	3283	3328	3147	3147	3147	3147	
Radius / radius	mm	143	145	145	147	139	139	139	139	
 9 (97%)	sec	27								
 9	sec	30								
Temperatur / temperature	°C ¹⁾	- 6								
Probenerwärmung/Sample temp. rise	K ²⁾	+ 10								

1324		1490 + 1492								
Ausschwingrotor 4-fach / Swing out rotor 4-times  90°		 mit Bioabdichtung / with bio-containment 5)								
		1348	1351	1363	1365	1383				
			2078	0536				0501		
										
Kapazität / capacity	ml	8,5 - 10	1,5	2,0	25	30	5	6	7	2,7 - 3
Maße / dimensions	∅ x L	mm	16 x 100	11 x 38	25 x 90	25 x 110	12 x 75	12 x 82	12 x 100	11 x 66
Anzahl p. Rotor / number p. rotor		16	20	4	4	20	20	20	20	
Drehzahl / speed	RPM	4500	4500	4500	4500	4500	4500	4500	4500	
RZB / RCF	³⁾	3147	3056	2920	3328	3192	3192	3192	3192	
Radius / radius	mm	139	135	129	147	141	141	141	141	
 9 (97%)	sec	27								
 9	sec	30								
Temperatur / temperature	°C ¹⁾	- 6								
Probenerwärmung/Sample temp. rise	K ²⁾	10								

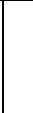
- 1) Tiefste erreichbare Temperatur bei maximaler Drehzahl, 1 h Laufzeit und 20°C Raumtemperatur (nur bei Kühlzentrifuge)
- 2) Probenerwärmung bei maximaler Drehzahl und 1 Stunde Laufzeit (nur bei Zentrifuge ohne Kühlung)
- 3) Zentrifugiergefäße aus Glas nur belastbar bis RZB 4000
- 5) Nach DIN EN 61010, Teil 2 – 020. Die Hinweise für Bio-Sicherheitssysteme in den Kapiteln "Sicherheitshinweise" und "Pflege und Wartung" beachten











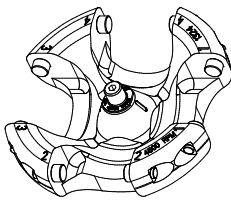

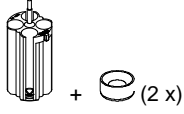

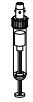
- 1) Lowest possible temperature during maximum speed, 1 h running time and 20°C ambient temperature (only with cooling centrifuges)
- 2) Sample temp. rise during maximum speed and 1 hour running time (only with centrifuges without cooling)
- 3) Centrifuge containers of glass will not stand RCF values exceeding 4000
- 5) in conformity with DIN EN 61010, part 2 – 020. Observe the notes for bio safety systems in chapters "Notes on safety" and "Maintenance and servicing".











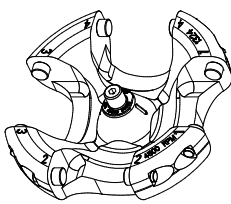

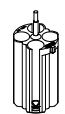
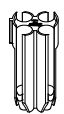
1324		1490 + 1492								
Ausschwingrotor 4-fach / Swing out rotor 4-times  		 mit Bioabdichtung / with bio-containment 5)								
		1383		1384		1396		1457		
										
										
Kapazität / capacity	ml	2,6 – 2,9	4,9	4,5 - 5	1,6 -5	4 – 7	50	85	1,1 – 1,4	
Maße / dimensions	∅ x L	mm	13 x 65	13 x 90	11 x 92	13 x 75	13 x 100	29 x 115	38 x 106	8 x 66
Anzahl p. Rotor / number p. rotor			20	20	20	20	20	4	4	28
Drehzahl / speed	RPM		4500	4500	4500	4500	4500	4500	4500	4500
RZB / RCF	³⁾		3192	3192	3192	3129	3129	3328	3260	3215
Radius / radius	mm		141	141	141	141	141	147	144	142
 9 (97%)	sec	27								
 9	sec	30								
Temperatur / temperature	°C ¹⁾	- 6								
Probenerwärmung/Sample temp. rise	K ²⁾	10								

1324		1490 + 1492													
Ausschwingrotor 4-fach / Swing out rotor 4-times  		 mit Bioabdichtung / with bio-containment 5)													
		1459		4416		4417		6311		6318		1356		0761	
															
															
Kapazität / capacity	ml	4 – 5,5	7,5 – 8,2	50	30	12	50	15	100						
Maße / dimensions	∅ x L	mm	15 x 75	15 x 92	29 x 107	26 x 95	17 x 100	29 x 115	17 x 120	44 x 100					
Anzahl p. Rotor / number p. rotor			16	16	4	4	4	4	12	4					
Drehzahl / speed	RPM		4500	4500	4500	4500	4500	4500	4500	4500					
RZB / RCF	³⁾		3215	3215	3283	3056	3328	3328	3328	3192					
Radius / radius	mm		142	142	145	135	147	147	147	141					
 9 (97%)	sec	27													
 9	sec	30													
Temperatur / temperature	°C ¹⁾	- 6													
Probenerwärmung/Sample temp. rise	K ²⁾	10													

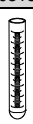
- 1) Tiefste erreichbare Temperatur bei maximaler Drehzahl, 1 h Laufzeit und 20°C Raumtemperatur (nur bei Kühlzentrifuge)
- 2) Probenerwärmung bei maximaler Drehzahl und 1 Stunde Laufzeit (nur bei Zentrifuge ohne Kühlung)
- 3) Zentrifugiergefäße aus Glas nur belastbar bis RZB 4000
- 5) Nach DIN EN 61010, Teil 2 – 020. Die Hinweise für Bio-Sicherheitssysteme in den Kapiteln "Sicherheitshinweise" und "Pflege und Wartung" beachten
- 7) nicht mit Deckel verschließbar











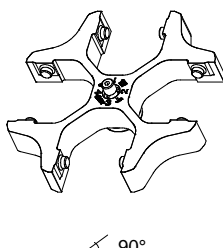
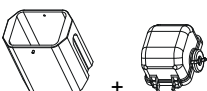



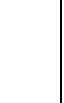

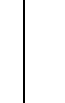

- 1) Lowest possible temperature during maximum speed, 1 h running time and 20°C ambient temperature (only with cooling centrifuges)
- 2) Sample temp. rise during maximum speed and 1 hour running time (only with centrifuges without cooling)
- 3) Centrifuge containers of glass will not stand RCF values exceeding 4000
- 5) in conformity with DIN EN 61010, part 2 – 020. Observe the notes for bio safety systems in chapters "Notes on safety" and "Maintenance and servicing".
- 7) not possible to close the lid





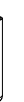





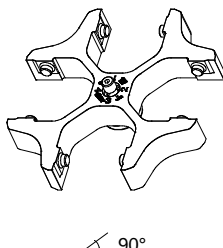
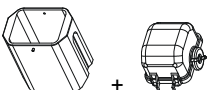





1324		1398								
Ausschwingrotor 4-fach / Swing out rotor 4-times  										
		1482A + 2 x 0716				1482A				
										
										
Kapazität / capacity	ml	2,6 – 2,9	4 – 4,5	9 – 10	10	12	4 - 7	8,5 – 10	9	
Maße / dimensions	∅ x L	mm	13 x 65	15 x 75	16 x 92	15 x 102	17 x 100	16 x 75	16 x 100	14 x 100
Anzahl p. Rotor / number p. rotor		16	16	16	16	16	16	16	16	
Drehzahl / speed	RPM	4500	4500	4500	4500	4500	4500	4500	4500	
RZB / RCF	³⁾	2875	2875	3192	3192	3192	3034	3034	3192	
Radius / radius	mm	127	127	141	141	141	134	134	141	
 9 (97%)	sec	27								
 9	sec	30								
Temperatur / temperature	°C ¹⁾	- 6								
Probenerwärmung/Sample temp. rise	K ²⁾	10								

1324		1398							
Ausschwingrotor 4-fach / Swing out rotor 4-times  									
		1482A	1483A	1484	1484				
				 ohne / without E2110-A					
0507	0518	0509	Falcon®	0513					
	 								
Kapazität / capacity	ml	15	15	50	50				
Maße / dimensions	∅ x L	mm	17 x 100	17 x 120	29 x 115	29 x 115			
Anzahl p. Rotor / number p. rotor		16	16	4	4				
Drehzahl / speed	RPM	4500	4500	4500	4500				
RZB / RCF	³⁾	3192	3305	3260	3260				
Radius / radius	mm	141	146	144	144				
 9 (97%)	sec	27							
 9	sec	30							
Temperatur / temperature	°C ¹⁾	- 6							
Probenerwärmung/Sample temp. rise	K ²⁾	10							

1) Tiefste erreichbare Temperatur bei maximaler Drehzahl, 1 h Laufzeit und 20°C Raumtemperatur (nur bei Kühlzentrifuge)
 2) Probenerwärmung bei maximaler Drehzahl und 1 Stunde Laufzeit (nur bei Zentrifuge ohne Kühlung)
 3) Zentrifugiergefäße aus Glas nur belastbar bis RZB 4000











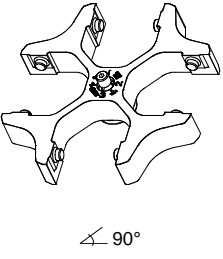
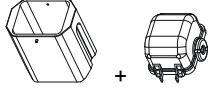

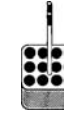

1) Lowest possible temperature during maximum speed, 1 h running time and 20°C ambient temperature (only with cooling centrifuges)
 2) Sample temp. rise during maximum speed and 1 hour running time (only with centrifuges without cooling)
 3) Centrifuge containers of glass will not stand RCF values exceeding 4000











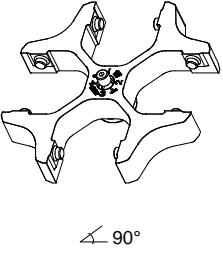
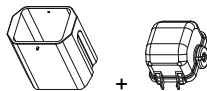



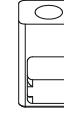





1494		1427 + 1421									
Ausschwingrotor 4-fach / Swing out rotor 4-times  ↙ 90°											
		1357	5229 ⁷⁾	5229	1326	5230	5230	5231	5231 ⁷⁾		
											
Rhe- sus	---			0501		0578		0507	0518		
											
Kapazität / capacity	ml	1	0,4	4,5 – 5	2,7 - 3	6	4	7	4,5 – 5	15	8,5 - 10
Maße / dimensions	∅ x L	mm	6 x 45	11 x 92	11x 66	12 x 82	12 x 60	12 x 100	11 x 92	17 x 100	16 x 100
Anzahl p. Rotor / number p. rotor			120	48	48	48	48	48	48	24	24
Drehzahl / speed	RPM		5000	5000	5000	5000	5000	5000	5000	5000	5000
RZB / RCF	³⁾		4081	4053	4053	4053	4053	3941	3941	3941	3941
Radius / radius	mm		146	145	145	145	145	141	141	141	141
	9 (97%)	sec	30								
	9	sec	32								
Temperatur / temperature	°C ¹⁾		- 7								
Probenerwärmung/Sample temp. rise	K ²⁾		+ 15								

1494		1427 + 1421									
Ausschwingrotor 4-fach / Swing out rotor 4-times  ↙ 90°											
		1731	1732			1732		5237	5279		
											
						0500					
											
Kapazität / capacity	ml	25	5	1,6 – 5	2,6 – 2,9	4,9	4 – 7	9	4 – 5,5		
Maße / dimensions	∅ x L	mm	25 x 90	12/13x75	13 x 75	13 x 65	13 x 90	13 x 100	14 x 100	15 x 75	
Anzahl p. Rotor / number p. rotor			8	32	32	32	32	32	24	20	
Drehzahl / speed	RPM		5000	5000	5000	5000	5000	5000	5000	5000	
RZB / RCF	³⁾		3969	4025	4025	4025	4025	4025	3941	4109	
Radius / radius	mm		142	144	144	144	144	144	141	147	
	9 (97%)	sec	30								
	9	sec	32								
Temperatur / temperature	°C ¹⁾		- 7								
Probenerwärmung/Sample temp. rise	K ²⁾		15								

- 1) Tiefste erreichbare Temperatur bei maximaler Drehzahl, 1 h Laufzeit und 20°C Raumtemperatur (nur bei Kühlzentrifuge)
- 2) Probenerwärmung bei maximaler Drehzahl und 1 Stunde Laufzeit (nur bei Zentrifuge ohne Kühlung)
- 3) Zentrifugiergefäße aus Glas nur belastbar bis RZB 4000
- 7) nicht mit Deckel verschließbar

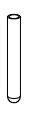









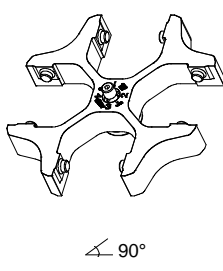







- 1) Lowest possible temperature during maximum speed, 1 h running time and 20°C ambient temperature (only with cooling centrifuges)
- 2) Sample temp. rise during maximum speed and 1 hour running time (only with centrifuges without cooling)
- 3) Centrifuge containers of glass will not stand RCF values exceeding 4000
- 7) not possible to close the lid











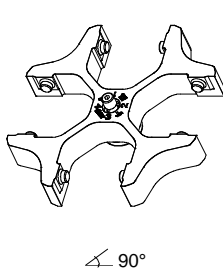

1494		1427 + 1421								
Ausschwingrotor 4-fach / Swing out rotor 4-times 										
		5279	5278	1327	5233	5271		5232	5275 ⁷⁾	
										
					0521			0519		0509
Kapazität / capacity	ml	7,5 – 8,2	1,1 – 1,4	3	50	9 - 10	4 - 7	25	15	
Maße / dimensions Ø x L	mm	15 x 92	8 x 66	10 x 60	34 x 100	16 x 92	16 x 75	24 x 100	17 x 120	
Anzahl p. Rotor / number p. rotor		20	48	48	4	20	20	8	4	
Drehzahl / speed	RPM	5000	5000	5000	5000	5000	5000	5000	5000	
RZB / RCF	³⁾	4109	4109	4053	3941	3969	3969	3941	4165	
Radius / radius	mm	147	147	145	141	142	142	141	149	
 9 (97%)	sec	30								
 9	sec	32								
Temperatur / temperature	°C ¹⁾	- 7								
Probenerwärmung/Sample temp. rise	K ²⁾	+ 15								

1494		1427 + 1421						1425				
Ausschwingrotor 4-fach / Swing out rotor 4-times 												
		5276	5277	5272	5273	1432	1433	1434				
												
		0513	2078	0536	---	---	Rhe- sus	---	0501	0578		
												
Kapazität / capacity	ml	50	1,5	2,0	30	1,5	2,0	1	0,4	3	6	7
Maße / dimensions Ø x L	mm	29 x 115	11 x 38		25 x 110	11 x 38		6 x 45	10 x 60		12 x 82	12 x 100
Anzahl p. Rotor / number p. rotor		4	36		4	48		144	56		48	48
Drehzahl / speed	RPM	5000	5000		5000	5000		5000	5000		5000	5000
RZB / RCF	³⁾	4053	4109		4025	4053		3969	3913		3913	3913
Radius / radius	mm	145	147		144	145		142	140		140	140
 9 (97%)	sec	30										
 9	sec	32										
Temperatur / temperature	°C ¹⁾	- 7										
Probenerwärmung/Sample temp. rise	K ²⁾	15										

- 1) Tiefste erreichbare Temperatur bei maximaler Drehzahl, 1 h Laufzeit und 20°C Raumtemperatur (nur bei Kühlzentrifuge)
- 2) Probenerwärmung bei maximaler Drehzahl und 1 Stunde Laufzeit (nur bei Zentrifuge ohne Kühlung)
- 3) Zentrifugiergefäße aus Glas nur belastbar bis RZB 4000
- 7) nicht mit Deckel verschließbar
- 6) Die Einlagen entfernen











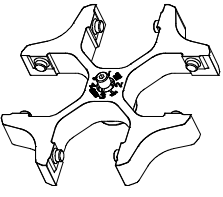



- 1) Lowest possible temperature during maximum speed, 1 h running time and 20°C ambient temperature (only with cooling centrifuges)
- 2) Sample temp. rise during maximum speed and 1 hour running time (only with centrifuges without cooling)
- 3) Centrifuge containers of glass will not stand RCF values exceeding 4000
- 7) not possible to close the lid
- 6) Remove the inserts











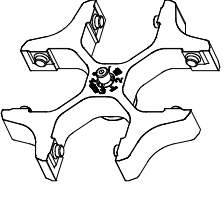
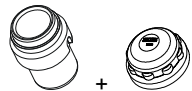
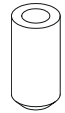



1494		1425								
Ausschwingrotor 4-fach / Swing out rotor 4-times  ↙ 90°										
		1431			1436	1437	1458	1435	1439	
										
		0500	0507	0518		0521	0526		0519	
										
Kapazität / capacity	ml	9	15	7,5 - 8,2	50	100	1,1 – 1,4	25	9 – 10	
Maße / dimensions	∅ x L	mm	14 x 100	17 x 100	15 x 92	34 x 100	44 x 100	8 x 66	24 x 100	16 x 92
Anzahl p. Rotor / number p. rotor		28	28	28	4	4	36	8	16	
Drehzahl / speed	RPM	5000	5000	5000	5000	5000	5000	5000	5000	
RZB / RCF	³⁾	3913	3913	3913	3913	3801	4025	3913	3913	
Radius / radius	mm	140	140	140	140	136	144	140	140	
 9 (97%)	sec	30								
 9	sec	32								
Temperatur / temperature	°C ¹⁾	- 10								
Probenerwärmung/Sample temp. rise	K ²⁾	12								

1494		1425								
Ausschwingrotor 4-fach / Swing out rotor 4-times  ↙ 90°										
		1438								
										
										
Kapazität / capacity	ml	2,6 – 2,9	2,7 – 3	4,9	4,5 – 5	1,6 – 5	4 – 7	5	4	
Maße / dimensions	∅ x L	mm	13 x 65	11 x 66	13 x 90	11 x 92	13 x 75	13 x 100	12/13x75	12 x 60
Anzahl p. Rotor / number p. rotor		28	28	28	28	28	28	28	28	
Drehzahl / speed	RPM	5000								
RZB / RCF	³⁾	3913								
Radius / radius	mm	140								
 9 (97%)	sec	30								
 9	sec	32								
Temperatur / temperature	°C ¹⁾	- 10								
Probenerwärmung/Sample temp. rise	K ²⁾	12								

- 1) Tiefste erreichbare Temperatur bei maximaler Drehzahl, 1 h Laufzeit und 20°C Raumtemperatur (nur bei Kühlzentrifuge)
- 2) Probenerwärmung bei maximaler Drehzahl und 1 Stunde Laufzeit (nur bei Zentrifuge ohne Kühlung)
- 3) Zentrifugiergefäße aus Glas nur belastbar bis RZB 4000

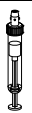

- 1) Lowest possible temperature during maximum speed, 1 h running time and 20°C ambient temperature (only with cooling centrifuges)
- 2) Sample temp. rise during maximum speed and 1 hour running time (only with centrifuges without cooling)
- 3) Centrifuge containers of glass will not stand RCF values exceeding 4000



1494		1425								
Ausschwingrotor 4-fach / Swing out rotor 4-times  ∠ 90°										
		1441		1443		1444		1737		
										
										
Kapazität / capacity	ml	4 – 5,5	7,5 – 8,5	4 – 7	8,5 – 10	50	1,5	2,0	50	
Maße / dimensions	∅ x L	mm	15 x 75	15 x 92	16 x 75	16 x 100	29 x 115	11 x 38	11 x 38	29 x 115
Anzahl p. Rotor / number p. rotor		28	28	28	28	4	36	36	4	
Drehzahl / speed	RPM	5000	5000	5000	5000	5000	5000	5000	5000	
RZB / RCF	³⁾	3913	3913	3913	3913	4081	3885	3885	4081	
Radius / radius	mm	140	140	140	140	146	139	139	146	
 9 (97%)	sec	30								
 9	sec	32								
Temperatur / temperature	°C ¹⁾	- 10								
Probenerwärmung/Sample temp. rise	K ²⁾	+ 12								

1494		1495 + 1492								
Ausschwingrotor 4-fach / Swing out rotor 4-times  ∠ 90°										
		mit Bioabdichtung / with bio-containment ⁵⁾								
		1363		1365		1348			0761	
										
										
Kapazität / capacity	ml	25	30	10	8	4 – 5,5	4 - 7	8,5 - 10	100	
Maße / dimensions	∅ x L	mm	25 x 90	25 x 110	16 x 80	16 x 81	15 x 75	16 x 75	16 x 100	44 x 100
Anzahl p. Rotor / number p. rotor		4	4	16	16	16	16	16	4	
Drehzahl / speed	RPM	5000	5000	5000	5000	5000	5000	5000	5000	
RZB / RCF	³⁾	3689	4193	4025	4025	4025	4025	4025	4025	
Radius / radius	mm	132	150	144	144	144	144	144	144	
 9 (97%)	sec	30								
 9	sec	32								
Temperatur / temperature	°C ¹⁾	- 10								
Probenerwärmung/Sample temp. rise	K ²⁾	14								

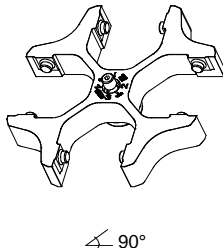
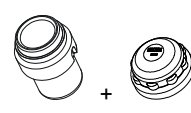
- 1) Tiefste erreichbare Temperatur bei maximaler Drehzahl, 1 h Laufzeit und 20°C Raumtemperatur (nur bei Kühlzentrifuge)
- 2) Probenerwärmung bei maximaler Drehzahl und 1 Stunde Laufzeit (nur bei Zentrifuge ohne Kühlung)
- 3) Zentrifugiergefäße aus Glas nur belastbar bis RZB 4000
- 5) Nach DIN EN 61010, Teil 2 – 020. Die Hinweise für Bio-Sicherheitssysteme in den Kapiteln "Sicherheitshinweise" und "Pflege und Wartung" beachten



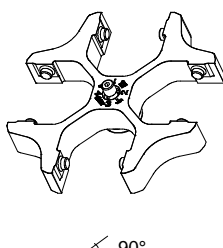
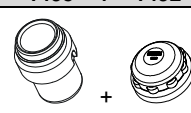





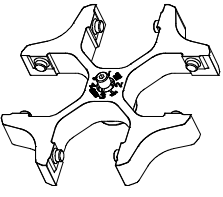
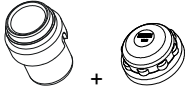

- 1) Lowest possible temperature during maximum speed, 1 h running time and 20°C ambient temperature (only with cooling centrifuges)
- 2) Sample temp. rise during maximum speed and 1 hour running time (only with centrifuges without cooling)
- 3) Centrifuge containers of glass will not stand RCF values exceeding 4000
- 5) in conformity with DIN EN 61010, part 2 – 020. Observe the notes for bio safety systems in chapters "Notes on safety" and "Maintenance and servicing".











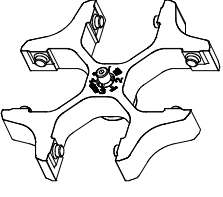
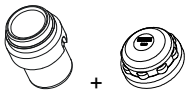

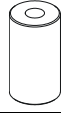

1494		1495 + 1492													
Ausschwingrotor 4-fach / Swing out rotor 4-times  ∠ 90°		 mit Bioabdichtung / with bio-containment 5)													
		1339		1343		1329			1330		1459				
		Rhe- sus		---		0500		0507	0518	0519					
Kapazität / capacity ml		1	0,4	3	4	9	15	9 - 10	25	4 - 5,5	7,5 - 8,2				
Maße / dimensions Ø x L mm		6 x 45		10 x 60	10 x 88	14 x 100		17 x 100		16 x 92		24 x 100	15 x 75	15 x 92	
Anzahl p. Rotor / number p. rotor		108		36		16		16		16		4		16	16
Drehzahl / speed RPM		5000		5000		5000		5000		5000		5000		5000	
RZB / RCF ³⁾		4081		4137		3997		3997		3997		3829		4053	
Radius / radius mm		146		148		143		143		143		137		145	
 9 (97%)														30	
 9														32	
Temperatur / temperature °C ¹⁾														- 10	
Probenerwärmung/Sample temp. rise K ²⁾														14	

1494		1495 + 1492													
Ausschwingrotor 4-fach / Swing out rotor 4-times  ∠ 90°		 mit Bioabdichtung / with bio-containment 5)													
		1331		1396		4416		4417		0761		1457		1383	
		0521		0547		0546		0545		0526					
Kapazität / capacity ml		50		85		50		30		100		1,1 - 1,4		1,6 - 5	4 - 7
Maße / dimensions Ø x L mm		34 x 100		38 x 106		29 x 107		26 x 95		44 x 100		8 x 66		13 x 75	13 x 100
Anzahl p. Rotor / number p. rotor		4		4		4		4		4		28		20	20
Drehzahl / speed RPM		5000		5000		5000		5000		5000		5000		5000	
RZB / RCF ³⁾		3801		4109		4137		3857		4025		4053		4025	
Radius / radius mm		136		147		148		138		144		145		144	
 9 (97%)														30	
 9														32	
Temperatur / temperature °C ¹⁾														- 10	
Probenerwärmung/Sample temp. rise K ²⁾														14	

- 1) Tiefste erreichbare Temperatur bei maximaler Drehzahl, 1 h Laufzeit und 20°C Raumtemperatur (nur bei Kühlzentrifuge)
- 2) Probenerwärmung bei maximaler Drehzahl und 1 Stunde Laufzeit (nur bei Zentrifuge ohne Kühlung)
- 3) Zentrifugiergefäße aus Glas nur belastbar bis RZB 4000
- 5) Nach DIN EN 61010, Teil 2 - 020. Die Hinweise für Bio-Sicherheitssysteme in den Kapiteln "Sicherheitshinweise" und "Pflege und Wartung" beachten



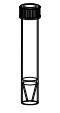







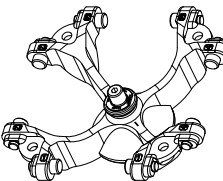

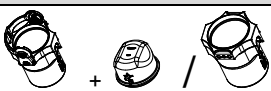





- 1) Lowest possible temperature during maximum speed, 1 h running time and 20°C ambient temperature (only with cooling centrifuges)
- 2) Sample temp. rise during maximum speed and 1 hour running time (only with centrifuges without cooling)
- 3) Centrifuge containers of glass will not stand RCF values exceeding 4000
- 5) in conformity with DIN EN 61010, part 2 - 020. Observe the notes for bio safety systems in chapters "Notes on safety" and "Maintenance and servicing".











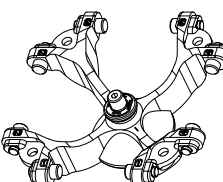

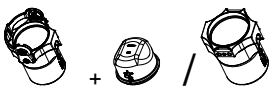



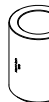

1494	1495 + 1492							
<p>Ausschwingrotor 4-fach / Swing out rotor 4-times</p>  <p>∠ 90°</p>	 +							
	mit Bioabdichtung / with bio-containment 5)							
	1383							
								
					0501	0578	---	
								
Kapazität / capacity	ml	2,6 – 2,9	2,7 – 3	4,9	4,5 - 5	6	7	5
Maße / dimensions	∅ x L	mm	13 x 65	11 x 66	13 x 90	11 x 92	12 x 100	12/13x75
Anzahl p. Rotor / number p. rotor		20	20	20	20	20	20	20
Drehzahl / speed	RPM	5000	5000	5000	5000	5000	5000	5000
RZB / RCF	³⁾	4025	4025	4025	4025	4025	4025	4025
Radius / radius	mm	144	144	144	144	144	144	144
 9 (97%)	sec	30						
 9	sec	32						
Temperatur / temperature	°C ¹⁾	- 10						
Probenerwärmung/Sample temp. rise	K ²⁾	14						

1494	1495 + 1492												
<p>Ausschwingrotor 4-fach / Swing out rotor 4-times</p>  <p>∠ 90°</p>	 +												
	mit Bioabdichtung / with bio-containment 5)												
	1351		1347		1384		0765		6311		6318		
													
2078		0536		0509		0513		0534 4)		0535		Falcon ®	
													
Kapazität / capacity	ml	1,5	2,0	15	50	30		12		50			
Maße / dimensions	∅ x L	mm	11 x 38	11 x 38	17 x 120	29 x 115		44 x 105		17 x 100		29 x 115	
Anzahl p. Rotor / number p. rotor		20	20	4	4	4		4		4		4	
Drehzahl / speed	RPM	5000	5000	5000	5000	5000		5000		5000		5000	
RZB / RCF	³⁾	3857	3857	4193	4193	3997		4193		4193		4193	
Radius / radius	mm	138	138	150	150	143		150		150		150	
 9 (97%)	sec	30											
 9	sec	32											
Temperatur / temperature	°C ¹⁾	- 10											
Probenerwärmung/Sample temp. rise	K ²⁾	14											

- 1) Tiefste erreichbare Temperatur bei maximaler Drehzahl, 1 h Laufzeit und 20°C Raumtemperatur (nur bei Kühlzentrifuge)
- 2) Probenerwärmung bei maximaler Drehzahl und 1 Stunde Laufzeit (nur bei Zentrifuge ohne Kühlung)
- 3) Zentrifugiergefäße aus Glas nur belastbar bis RZB 4000
- 4) nicht mit Stopfen zentrifugierbar, Skal. 10µl-300µl, 15ml, 30ml
- 5) Nach DIN EN 61010, Teil 2 – 020. Die Hinweise für Bio-Sicherheitssysteme in den Kapiteln "Sicherheitshinweise" und "Pflege und Wartung" beachten









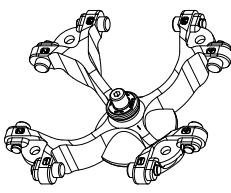

- 1) Lowest possible temperature during maximum speed, 1 h running time and 20°C ambient temperature (only with cooling centrifuges)
- 2) Sample temp. rise during maximum speed and 1 hour running time (only with centrifuges without cooling)
- 3) Centrifuge containers of glass will not stand RCF values exceeding 4000
- 4) can not be centrifugated when plug is attached, Scal. 10µl-300µl, 15ml, 30ml
- 5) in conformity with DIN EN 61010, part 2 – 020. Observe the notes for bio safety systems in chapters "Notes on safety" and "Maintenance and servicing".











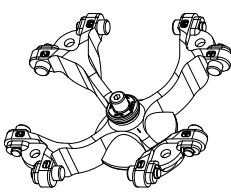



1554	1560 + 1561 / 1565									
Ausschwingrotor 4-fach / Swing out rotor 4-times   max. Laufzyklen / max. cycles 100 000	 + /									
	mit Bioabdichtung / with bio-containment 5) -----									
	max. Laufzyklen / max. cycles: 80000									
	max. Beladung / max. load: 290 g									
	1571		1593		1589			1588		
										
	2078	0536	----	0553	0501	0578	0500	0507	0518	
										
Kapazität / capacity	ml		1,5		2,0		5		5	
Maße / dimensions Ø x L	mm		11 x 38		17 x 59		12 x 75		12 x 82	
Anzahl p. Rotor / number p. rotor			56		16		28		20	
Drehzahl / speed	RPM				4500					
RZB / RCF	3)		3328/2332		3328				3215	
Radius / radius	mm		147/103		147				142	
 9 (97%)	sec								28	
 9	sec								31	
Temperatur / temperature	°C 1)								- 8	
Probenerwärmung/Sample temp. rise	K 2)								10	

1554	1560 + 1561 / 1565									
Ausschwingrotor 4-fach / Swing out rotor 4-times   max. Laufzyklen / max. cycles 100 000	 + /									
	mit Bioabdichtung / with bio-containment 5) -----									
	max. Laufzyklen / max. cycles: 80000									
	max. Beladung / max. load: 290 g									
	1572	1573	1574	1575	1576	1594		---		
										
	Corex®	0519	0521	0549	0526	---				
										
Kapazität / capacity	ml		15		25		50		85	
Maße / dimensions Ø x L	mm		18 x 102		24 x 100		34 x 100		38 x 101	
Anzahl p. Rotor / number p. rotor			16				4			
Drehzahl / speed	RPM				4500					
RZB / RCF	3)		3260		3056		3124		3260	
Radius / radius	mm		144		135		138		144	
 9 (97%)	sec								28	
 9	sec								31	
Temperatur / temperature	°C 1)								- 8	
Probenerwärmung/Sample temp. rise	K 2)								10	

- 1) Tiefste erreichbare Temperatur bei maximaler Drehzahl, 1 h Laufzeit und 20°C Raumtemperatur (nur bei Kühlzentrifuge)
- 2) Probenerwärmung bei maximaler Drehzahl und 1 Stunde Laufzeit (nur bei Zentrifuge ohne Kühlung)
- 3) Zentrifugiergefäße aus Glas nur belastbar bis RZB 4000
- 5) Nach DIN EN 61010, Teil 2 – 020. Die Hinweise für Bio-Sicherheitssysteme in den Kapiteln "Sicherheitshinweise" und "Pflege und Wartung" beachten.
- 7) nicht mit Deckel verschließbar











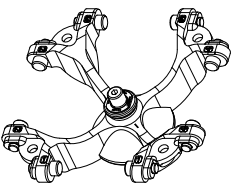

- 1) Lowest possible temperature during maximum speed, 1 h running time and 20°C ambient temperature (only with cooling centrifuges)
- 2) Sample temp. rise during maximum speed and 1 hour running time (only with centrifuges without cooling)
- 3) Centrifuge containers of glass will not stand RCF values exceeding 4000
- 5) in conformity with DIN EN 61010, part 2 – 020. Observe the notes for bio safety systems in chapters "Notes on safety" and "Maintenance and servicing".
- 7) not possible to close the lid







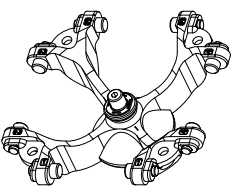

1554	1560 + 1561 / 1565										
Ausschwingrotor 4-fach / Swing out rotor 4-times  $\angle 90^\circ$ max. Laufzyklen / max. cycles 100 000	 mit Bioabdichtung / with bio-containment 5)										
	max. Laufzyklen / max. cycles: 80000 max. Beladung / max. load: 290 g										
	1589					1588					
											
	---		---		---		---		---		
											
Kapazität / capacity	ml	1,1 - 1,4	2,6 - 3,4	4,9	2,7 - 3	4 - 5,5	4 - 5,5	7,5 - 8,5	9 - 10	10	
Maße / dimensions \varnothing x L	mm	8 x 66	13 x 65	13 x 90	11 x 66	11 x 92	15 x 75	15 x 92	16 x 92	15 x 102	
Anzahl p. Rotor / number p. rotor		28					20				
Drehzahl / speed	RPM						4500				
RZB / RCF							3215				
Radius / radius	mm						142				
 9 (97%)	sec						28				
 9	sec						31				
Temperatur / temperature	$^\circ\text{C}^{1)}$						- 8				
Probenerwärmung/Sample temp. rise	K ²⁾						10				

1554	1560 + 1561 / 1565											
Ausschwingrotor 4-fach / Swing out rotor 4-times  $\angle 90^\circ$ max. Laufzyklen / max. cycles 100 000	 mit Bioabdichtung / with bio-containment 5)											
	max. Laufzyklen / max. cycles: 80000 max. Beladung / max. load: 290 g											
	1589		1588		1591		1581 + E2109		1577		1595	
												
	---		---		---		0509		---			
												
Kapazität / capacity	ml	1,6 - 5	4 - 7	4 - 7	8,5 - 10	12	11	15				
Maße / dimensions \varnothing x L	mm	13 x 75	13 x 100	16 x 75	16 x 100	17 x 102	16 x 110	17 x 120				
Anzahl p. Rotor / number p. rotor		28		20		12		8		12		
Drehzahl / speed	RPM						4500					
RZB / RCF							3215		3260		3328	
Radius / radius	mm						142		144		147	
 9 (97%)	sec						28					
 9	sec						31					
Temperatur / temperature	$^\circ\text{C}^{1)}$						- 8					
Probenerwärmung/Sample temp. rise	K ²⁾						10					

- 1) Tiefste erreichbare Temperatur bei maximaler Drehzahl, 1 h Laufzeit und 20°C Raumtemperatur (nur bei Kühlzentrifuge)
- 2) Probenerwärmung bei maximaler Drehzahl und 1 Stunde Laufzeit (nur bei Zentrifuge ohne Kühlung)
- 3) Zentrifugiergefäße aus Glas nur belastbar bis RZB 4000
- 5) Nach DIN EN 61010, Teil 2 – 020. Die Hinweise für Bio-Sicherheitssysteme in den Kapiteln "Sicherheitshinweise" und "Pflege und Wartung" beachten.
- 7) nicht mit Deckel verschließbar





- 1) Lowest possible temperature during maximum speed, 1 h running time and 20°C ambient temperature (only with cooling centrifuges)
- 2) Sample temp. rise during maximum speed and 1 hour running time (only with centrifuges without cooling)
- 3) Centrifuge containers of glass will not stand RCF values exceeding 4000
- 5) In conformity with DIN EN 61010, part 2 – 020. Observe the notes for bio safety systems in chapters "Notes on safety" and "Maintenance and servicing".
- 7) not possible to close the lid





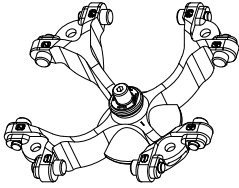

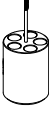
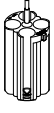
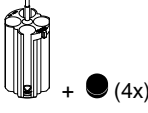
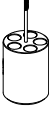
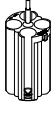



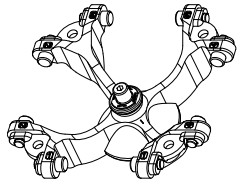

1554		1560 + 1561 / 1565								
Ausschwingrotor 4-fach / Swing out rotor 4-times   90° max. Laufzyklen / max. cycles 100 000		 mit Bioabdichtung / with bio-containment 5) ----- max. Laufzyklen / max. cycles: 80000 max. Beladung / max. load: 290 g								
		1578	1579	1581	1582	1583	1584	1585		
		---	0513	---	---	---	---	0545		
										
Kapazität / capacity	ml	30	50	12	25	30	50	10	30	
Maße / dimensions	∅ x L	mm	25 x 110	30 x 115	17 x 100	25 x 90	25 x 110	29 x 115	16 x 80	26 x 95
Anzahl p. Rotor / number p. rotor		4		16	4		20	4		
Drehzahl / speed	RPM	4500								
RZB / RCF	³⁾	3328		3260	3328		3215	3260		
Radius / radius	mm	147		144	147		142	144		
 9 (97%)	sec	28								
 9	sec	31								
Temperatur / temperature	°C ¹⁾	- 8								
Probenerwärmung / Sample temp. rise	K ²⁾	10								

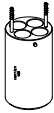
1554		1560 + 1561 / 1565							
Ausschwingrotor 4-fach / Swing out rotor 4-times   90° max. Laufzyklen / max. cycles 100 000		 mit Bioabdichtung / with bio-containment 5) ----- max. Laufzyklen / max. cycles: 80000 max. Beladung / max. load: 290 g							
		1586	1575	1587					
		0546	0547	0539 / 0538	0534 ⁴⁾				
									
Kapazität / capacity	ml	50	85	94	30				
Maße / dimensions	∅ x L	mm	29 x 107	38 x 106	38 x 102	44 x 105			
Anzahl p. Rotor / number p. rotor		4							
Drehzahl / speed	RPM	4500							
RZB / RCF	³⁾	3260		3192					
Radius / radius	mm	144		141					
 9 (97%)	sec	28							
 9	sec	31							
Temperatur / temperature	°C ¹⁾	- 8							
Probenerwärmung / Sample temp. rise	K ²⁾	10							

- 1) Tiefste erreichbare Temperatur bei maximaler Drehzahl, 1 h Laufzeit und 20°C Raumtemperatur (nur bei Kühlzentrifuge)
- 2) Probenerwärmung bei maximaler Drehzahl und 1 Stunde Laufzeit (nur bei Zentrifuge ohne Kühlung)
- 3) Zentrifugiergefäße aus Glas nur belastbar bis RZB 4000
- 4) nicht mit Stopfen zentrifugierbar, Skal. 10µl-300µl, 15ml, 30ml
- 5) Nach DIN EN 61010, Teil 2 – 020. Die Hinweise für Bio-Sicherheitssysteme in den Kapiteln "Sicherheitshinweise" und "Pflege und Wartung" beachten.

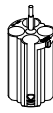







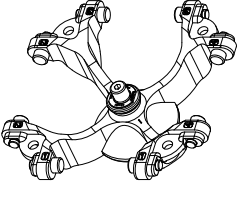

- 1) Lowest possible temperature during maximum speed, 1 h running time and 20°C ambient temperature (only with cooling centrifuges)
- 2) Sample temp. rise during maximum speed and 1 hour running time (only with centrifuges without cooling)
- 3) Centrifuge containers of glass will not stand RCF values exceeding 4000
- 4) can not be centrifugated when plug is attached, Scal. 10µl-300µl, 15ml, 30ml
- 5) In conformity with DIN EN 61010, part 2 – 020. Observe the notes for bio safety systems in chapters "Notes on safety" and "Maintenance and servicing".

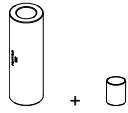
1554		1559													
Ausschwingrotor 4-fach / Swing out rotor 4-times  $\angle 90^\circ$ max. Laufzyklen / max. cycles 100 000		 max. Laufzyklen / max. cycles: 80000 max. Beladung / max. load: 200 g													
		1486		1482A			1482A + 4 x 0715			1486			1482A		
															
Kapazität / capacity ml		0553	0501	0578	0500	0507	0518								
Maße / dimensions \varnothing x L mm		5	6	7	9	15		4 - 7	4 - 5,5	2,6 - 3,4	2,7 - 3	4,5 - 5	4,9	9-10	10
Anzahl p. Rotor / number p. rotor		20			16			16		20		20		16	
Drehzahl / speed RPM		4500													
RZB / RCF ³⁾		3215			3260			3215		3215		3260		3260	
Radius / radius mm		142			144			142		142		144		144	
 9 (97%) sec		28													
 9 sec		31													
Temperatur / temperature °C ¹⁾		- 8													
Probenerwärmung/Sample temp. rise K ²⁾		9													

1554		1559															
Ausschwingrotor 4-fach / Swing out rotor 4-times  $\angle 90^\circ$ max. Laufzyklen / max. cycles 100 000		 max. Laufzyklen / max. cycles: 80000 max. Beladung / max. load: 200 g															
		1486		1482A		1488		1487		1483A		1484		1482A		1484	
																	
Kapazität / capacity ml		1,6 - 5	4 - 7	8,5-10	8	12	15	50	12	50	---		---				
Maße / dimensions \varnothing x L mm		13 x 75	13 x 100	16x100	16 x 125	17 x 102	17 x 120	29 x 115	17 x 100	29 x 115							
Anzahl p. Rotor / number p. rotor		20		16		12		16		4		16		4			
Drehzahl / speed RPM		4500															
RZB / RCF ³⁾		3215	3260	3328	3147	3351	3305	3260	3305								
Radius / radius mm		142	144	147	139	148	146	144	146								
 9 (97%) sec		28															
 9 sec		31															
Temperatur / temperature °C ¹⁾		- 8															
Probenerwärmung/Sample temp. rise K ²⁾		9															











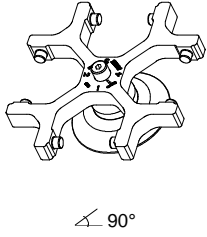



1) Tiefste erreichbare Temperatur bei maximaler Drehzahl, 1 h Laufzeit und 20°C Raumtemperatur (nur bei Kühlzentrifuge)
 2) Probenerwärmung bei maximaler Drehzahl und 1 Stunde Laufzeit (nur bei Zentrifuge ohne Kühlung)
 3) Zentrifugiergefäße aus Glas nur belastbar bis RZB 4000





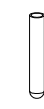

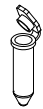



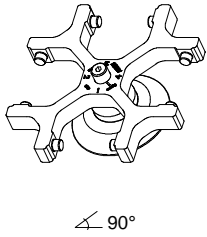

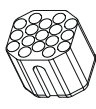

1) Lowest possible temperature during maximum speed, 1 h running time and 20°C ambient temperature (only with cooling centrifuges)
 2) Sample temp. rise during maximum speed and 1 hour running time (only with centrifuges without cooling)
 3) Centrifuge containers of glass will not stand RCF values exceeding 4000

1554		1563					
<p>Ausschwingrotor 4-fach / Swing out rotor 4-times</p>  <p>∠ 90°</p> <p>max. Laufzyklen / max. cycles 100 000</p>							
		max. Laufzyklen / max. cycles: 80000					
		max. Beladung / max. load: 160					
		1592	1592 + E2109	E2110-A			
							
		---	0509	0513	---		
							
Kapazität / capacity	ml	12	15	50	50		
Maße / dimensions	∅ x L	17 x 100	17 x 120	29 x 115	29 x 115		
Anzahl p. Rotor / number p. rotor		8					
Drehzahl / speed	RPM	4500					
RZB / RCF	³⁾	3260					
Radius / radius	mm	144					
 9 (97%)	sec	28					
 9	sec	31					
Temperatur / temperature	°C ¹⁾	- 8					
Probenerwärmung/Sample temp. rise	K ²⁾	10					

- 1) Tiefste erreichbare Temperatur bei maximaler Drehzahl, 1 h Laufzeit und 20°C Raumtemperatur (nur bei Kühlzentrifuge)
- 2) Probenerwärmung bei maximaler Drehzahl und 1 Stunde Laufzeit (nur bei Zentrifuge ohne Kühlung)
- 3) Zentrifugiergefäße aus Glas nur belastbar bis RZB 4000





- 1) Lowest possible temperature during maximum speed, 1 h running time and 20°C ambient temperature (only with cooling centrifuges)
- 2) Sample temp. rise during maximum speed and 1 hour running time (only with centrifuges without cooling)
- 3) Centrifuge containers of glass will not stand RCF values exceeding 4000



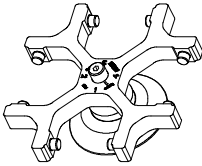

1624		1308	1345	1346	1366					
Ausschwingrotor 4-fach / Swing out rotor 4-times  ∠ 90°										
					1326	1357	5277			
		0521					Rhe- sus		2078	0536
										
Kapazität / capacity	ml	50	45	20	4	0,4	1	3	1,5	2,0
Maße / dimensions	∅ x L	mm	34 x 100	31 x 100	21 x 100	12 x 60	6 x 45	10 x 60	11 x 38	
Anzahl p. Rotor / number p. rotor		4	4	8	48	120	36	36		
Drehzahl / speed	RPM	4000	4000	4000	4000	4000	4000	4000	4000	4000
RZB / RCF		2290	2361	2361	1932	1950	1968	1968	1968	1968
Radius / radius	mm	128	132	132	108	109	110	110	110	110
 9 (97%)	sec	20								
 9	sec	25								
Temperatur / temperature	°C ¹⁾	- 15								
Probenerwärmung/Sample temp. rise	K ²⁾	8								

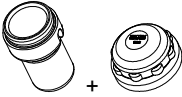
1624											
Ausschwingrotor 4-fach / Swing out rotor 4-times  ∠ 90°											
		1369		1369-91		1369-92		1370		1372	
											
0507	0518			0578	0501	0500					
											
Kapazität / capacity	ml	15	8,5 - 10	5	7	6	9	5			
Maße / dimensions	∅ x L	mm	17 x 100	16 x 100	12 x 75	12 x 100	12 x 82	14 x 100	12 x 75		
Anzahl p. Rotor / number p. rotor		16	16	16	16	16	20	68			
Drehzahl / speed	RPM	4000	4000	4000	4000	4000	4000	4000	4000		
RZB / RCF		2308	2308	2057	2308	2308	2308	2308	2164		
Radius / radius	mm	129	129	115	129	129	129	129	121		
 9 (97%)	sec	20									
 9	sec	25									
Temperatur / temperature	°C ¹⁾	- 17									
Probenerwärmung/Sample temp. rise	K ²⁾	8									

- 1) Tiefste erreichbare Temperatur bei maximaler Drehzahl, 1 h Laufzeit und 20°C Raumtemperatur (nur bei Kühlzentrifuge)
- 2) Probenerwärmung bei maximaler Drehzahl und 1 Stunde Laufzeit (nur bei Zentrifuge ohne Kühlung)
- 3) Zentrifugiergefäße aus Glas nur belastbar bis RZB 4000

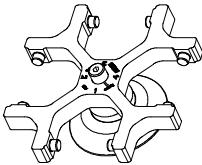

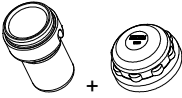







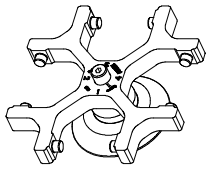
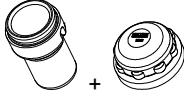

- 1) Lowest possible temperature during maximum speed, 1 h running time and 20°C ambient temperature (only with cooling centrifuges)
- 2) Sample temp. rise during maximum speed and 1 hour running time (only with centrifuges without cooling)
- 3) Centrifuge containers of glass will not stand RCF values exceeding 4000











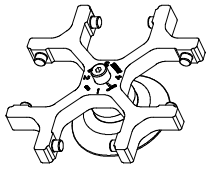
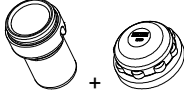



1624		1481 + 1492								
Ausschwingrotor 4-fach / Swing out rotor 4-times  		 mit Bioabdichtung / with bio-containment 5)								
		1329				1330		1331	1339	1347
		0500		0507	0518			0519	0521	Rhesus
Kapazität / capacity	ml	9	15	9 - 10	10	25	50	1	15	
Maße / dimensions $\varnothing \times L$	mm	14 x 100	17 x 100	16 x 92	15 x 102	24 x 100	34 x 100	6 x 45	17 x 120	
Anzahl p. Rotor / number p. rotor		16	16	16	16	4	4	108	4	
Drehzahl / speed	RPM	4000	4000	4000	4000	4000	4000	4000	4000	
RZB / RCF		2540	2540	2540	2540	2433	2415	2594	2665	
Radius / radius	mm	142	142	142	142	136	135	145	149	
 9 (97%)	sec	20								
 9	sec	25								
Temperatur / temperature	$^{\circ}\text{C}^{1)}$	- 15								
Probenerwärmung/Sample temp. rise	$\text{K}^{2)}$	7								

1624		1481 + 1492							
Ausschwingrotor 4-fach / Swing out rotor 4-times  		 mit Bioabdichtung / with bio-containment 5)							
		1348				1351		6311	6318
		2078		0536				Falcon®	
Kapazität / capacity	ml	10	4 - 7	8,5 - 10	8	1,5	2,0	12	50
Maße / dimensions $\varnothing \times L$	mm	16 x 80	16 x 75	16 x 100	16 x 81	11 x 38	11 x 38	17 x 100	29 x 115
Anzahl p. Rotor / number p. rotor		16	16	16	16	20	20	4	4
Drehzahl / speed	RPM	4000	4000	4000	4000	4000	4000	4000	4000
RZB / RCF		2522	2522	2522	2522	2451	2451	2665	2665
Radius / radius	mm	141	141	141	141	137	137	149	149
 9 (97%)	sec	20							
 9	sec	25							
Temperatur / temperature	$^{\circ}\text{C}^{1)}$	- 15							
Probenerwärmung/Sample temp. rise	$\text{K}^{2)}$	7							

- 1) Tiefste erreichbare Temperatur bei maximaler Drehzahl, 1 h Laufzeit und 20°C Raumtemperatur (nur bei Kühlzentrifuge)
- 2) Probenerwärmung bei maximaler Drehzahl und 1 Stunde Laufzeit (nur bei Zentrifuge ohne Kühlung)
- 5) Nach DIN EN 61010, Teil 2 – 020. Die Hinweise für Bio-Sicherheitssysteme in den Kapiteln "Sicherheitshinweise" und "Pflege und Wartung" beachten
- 6) Die Einlagen entfernen

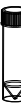



- 1) Lowest possible temperature during maximum speed, 1 h running time and 20°C ambient temperature (only with cooling centrifuges)
- 2) Sample temp. rise during maximum speed and 1 hour running time (only with centrifuges without cooling)
- 5) in conformity with DIN EN 61010, part 2 – 020. Observe the notes for bio safety systems in chapters "Notes on safety" and "Maintenance and servicing".
- 6) Remove the inserts





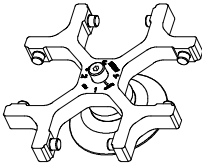

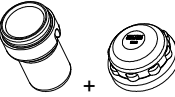
1624	1481 + 1492								
Ausschwingrotor 4-fach / Swing out rotor 4-times  ↙ 90°	 mit Bioabdichtung / with bio-containment 5)								
	1383								
									
	0501	0578							---
									
Kapazität / capacity	ml	6	7	4,9	4,5 - 5,0	2,7 - 3,0	2,6 - 2,9	1,6 - 5,0	5
Maße / dimensions	Ø x L	mm	12 x 82	12 x 100	13 x 90	11 x 92	11 x 66	13 x 75	12 x 75
Anzahl p. Rotor / number p. rotor		20	20	20	20	20	20	20	20
Drehzahl / speed	RPM	4000	4000	4000	4000	4000	4000	4000	4000
RZB / RCF		2558	2558	2558	2558	2558	2558	2558	2558
Radius / radius	mm	143	143	143	143	143	143	143	143
 9 (97%)	sec	20							
 9	sec	25							
Temperatur / temperature	°C ¹⁾	- 15							
Probenerwärmung/Sample temp. rise	K ²⁾	7							

1624	1481 + 1492								
Ausschwingrotor 4-fach / Swing out rotor 4-times  ↙ 90°	 mit Bioabdichtung / with bio-containment 5)								
	1383	1384	1396	1457	1343	1363	1365		
									
	0513	0547							
									
Kapazität / capacity	ml	4 - 7,0	50	85	1,1 - 1,4	3	4	25	30
Maße / dimensions	Ø x L	mm	13 x 100	29 x 115	38 x 106	8 x 66	10 x 60	10 x 88	25 x 110
Anzahl p. Rotor / number p. rotor		20	4	4	28	36	36	4	4
Drehzahl / speed	RPM	4000	4000	4000	4000	4000	4000	4000	4000
RZB / RCF		2558	2665	2612	2576	2630	2630	2343	2665
Radius / radius	mm	143	149	146	144	147	147	131	149
 9 (97%)	sec	20							
 9	sec	25							
Temperatur / temperature	°C ¹⁾	- 15							
Probenerwärmung/Sample temp. rise	K ²⁾	7							

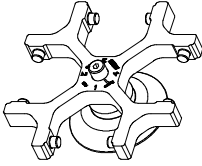
- 1) Tiefste erreichbare Temperatur bei maximaler Drehzahl, 1 h Laufzeit und 20°C Raumtemperatur (nur bei Kühlzentrifuge)
- 2) Probenerwärmung bei maximaler Drehzahl und 1 Stunde Laufzeit (nur bei Zentrifuge ohne Kühlung)
- 5) Nach DIN EN 61010, Teil 2 - 020. Die Hinweise für Bio-Sicherheitssysteme in den Kapiteln "Sicherheitshinweise" und "Pflege und Wartung" beachten











- 1) Lowest possible temperature during maximum speed, 1 h running time and 20°C ambient temperature (only with cooling centrifuges)
- 2) Sample temp. rise during maximum speed and 1 hour running time (only with centrifuges without cooling)
- 5) in conformity with DIN EN 61010, part 2 - 020. Observe the notes for bio safety systems in chapters "Notes on safety" and "Maintenance and servicing".







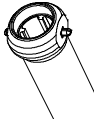
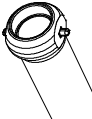

1624		1481 + 1492										
Ausschwingrotor 4-fach / Swing out rotor 4-times  		 +										
		mit Bioabdichtung / with bio-containment 5)										
		1459	4416	4417	0761	0765		1745		1746		
		0546	0545	0526	0534 4)	0535	0519	0545	0521			
Kapazität / capacity	ml	4,0 - 5,5	7,5 - 8,2	50	30	100	30		25	30	50	
Maße / dimensions	∅ x L	mm	15 x 75	15 x 92	29 x 107	26 x 95	44 x 10	44 x 105		24 x 100	26 x 95	34 x 100
Anzahl p. Rotor / number p. rotor		16		4	4	4	4		8		4	
Drehzahl / speed	RPM	4000		4000	4000	4000	4000		4000		4000	
RZB / RCF		2576		2630	2451	2558	2540		2451		2451	
Radius / radius	mm	144		147	137	143	142		137		137	
 9 (97%)	sec	20										
 9	sec	25										
Temperatur / temperature	°C ¹⁾	- 15										
Probenerwärmung/Sample temp. rise	K ²⁾	7										

1624		1741			1742				1739			
Ausschwingrotor 4-fach / Swing out rotor 4-times  												
		0701						0716				
		0500			0507	0518						
Kapazität / capacity	ml	9	1,1 – 1,4	4,9	15	15	1,6 – 5	4 - 7	2,6 – 2,9	4 – 5,5	4 - 7	
Maße / dimensions	∅ x L	mm	14 x 100	8 x 66	13 x 90	17 x 100	17 x 100	13 x 75	16 x 75	13 x 65	15 x 75	13 x 100
Anzahl p. Rotor / number p. rotor		40		40	40	28	28		28		28	
Drehzahl / speed	RPM	4000		4000	4000	4000	4000		4000		4000	
RZB / RCF		2415		2415	2451	2451	2451		2325		2451	
Radius / radius	mm	135		135	137	137	137		130		137	
 9 (97%)	sec	20										
 9	sec	25										
Temperatur / temperature	°C ¹⁾	- 15										
Probenerwärmung/Sample temp. rise	K ²⁾	9										

1) Tiefste erreichbare Temperatur bei maximaler Drehzahl, 1 h Laufzeit und 20°C Raumtemperatur (nur bei Kühlzentrifuge)
 2) Probenerwärmung bei maximaler Drehzahl und 1 Stunde Laufzeit (nur bei Zentrifuge ohne Kühlung)
 4) nicht mit Stopfen zentrifugierbar, Skal. 10µl-300µl, 15ml, 30ml
 5) Nach DIN EN 61010, Teil 2 – 020. Die Hinweise für Bio-Sicherheitssysteme in den Kapiteln "Sicherheitshinweise" und "Pflege und Wartung" beachten







1) Lowest possible temperature during maximum speed, 1 h running time and 20°C ambient temperature (only with cooling centrifuges)
 2) Sample temp. rise during maximum speed and 1 hour running time (only with centrifuges without cooling)
 4) can not be centrifuged when plug is attached, Scal. 10µl-300µl, 15ml, 30ml
 5) in conformity with DIN EN 61010, part 2 – 020. Observe the notes for bio safety systems in chapters "Notes on safety" and "Maintenance and servicing".



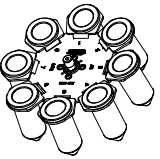







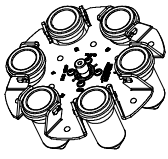

1611	1131					1132		
Ausschwingrotor 8-fach / Swing out rotor 8-times  $\angle 90^\circ$								
	---	0501				2079		
Kapazität / capacity ml	5	6	2,7 – 3,0	2,6 - 2,9	1,6 – 5,0	10	4 – 5,5	4 - 7
Maße / dimensions \varnothing x L mm	12/13 x 75	12 x 82	11 x 66	13 x 65	13 x 75	17 x 70	15 x 75	16 x 75
Anzahl p. Rotor / number p. rotor	8							
Drehzahl / speed RPM	4000							
RZB / RCF	1914							
Radius / radius mm	107							
 9 (97%) sec	20							
 9 sec	20							
Temperatur / temperature $^\circ\text{C}^{1)}$	- 16							
Probenerwärmung/Sample temp. rise $\text{K}^{2)}$	4							

1611	1643				1644			
Ausschwingrotor 8-fach / Swing out rotor 8-times  $\angle 90^\circ$								
	0578				0507	0518		
Kapazität / capacity ml	7	4 – 7	10	4,5 - 5	15	7,5 – 8,2	8,5 - 10	
Maße / dimensions \varnothing x L mm	12 x 100	13 x 100	13 x 100	11 x 92	17 x 100	15 x 92	16 x 100	
Anzahl p. Rotor / number p. rotor	8							
Drehzahl / speed RPM	4000							
RZB / RCF	2415							
Radius / radius mm	135							
 9 (97%) sec	20							
 9 sec	20							
Temperatur / temperature $^\circ\text{C}^{1)}$	- 16							
Probenerwärmung/Sample temp. rise $\text{K}^{2)}$	7							

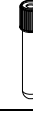
- 1) Tiefste erreichbare Temperatur bei maximaler Drehzahl, 1 h Laufzeit und 20°C Raumtemperatur (nur bei Kühlzentrifuge)
 2) Probenerwärmung bei maximaler Drehzahl und 1 Stunde Laufzeit (nur bei Zentrifuge ohne Kühlung)









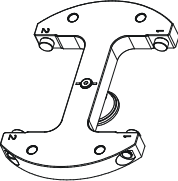

- 1) Lowest possible temperature during maximum speed, 1 h running time and 20°C ambient temperature (only with cooling centrifuges)
 2) Sample temp. rise during maximum speed and 1 hour running time (only with centrifuges without cooling)

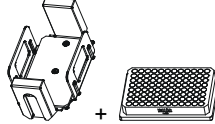









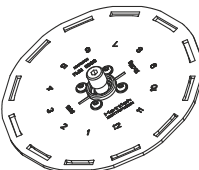





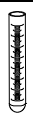

1617									
Ausschwingrotor 8-fach / Swing out rotor 8-times  		1462-A							
			---						
		0509	0513						
									
Kapazität / capacity	ml	15	50						
Maße / dimensions	∅ x L mm	17 x 120	29 x 115						
Anzahl p. Rotor / number p. rotor		8	8						
Drehzahl / speed	RPM	5000	5000						
RZB / RCF		3857	3857						
Radius / radius	mm	138							
 9 (97%)	sec	20							
 9	sec	19							
Temperatur / temperature	°C ¹⁾	- 10							
Probenerwärmung/Sample temp. rise	K ²⁾	14							

1619									
Ausschwingrotor 6-fach / Swing out rotor 6-times  		1462-A							
			---	SK 56.04-4					
		0509	0513						
									
Kapazität / capacity	ml	15	50	12	8	8,5 – 10	7,5-8,2	9-10	10
Maße / dimensions	∅ x L mm	17 x 120	29 x 115	16 x 101	16 x 125	16 x 100	15 x 92	16 x 92	15 x 102
Anzahl p. Rotor / number p. rotor		6	6	6	6	6	6	6	6
Drehzahl / speed	RPM	4000	4000	4000	4000	4000	4000	4000	4000
RZB / RCF		2701	2701	2647	2647	2647	2647	2647	2647
Radius / radius	mm	151	151	148	148	148	148	148	148
 9 (97%)	sec	20							
 9	sec	22							
Temperatur / temperature	°C ¹⁾	- 15							
Probenerwärmung/Sample temp. rise	K ²⁾	9							

- 1) Tiefste erreichbare Temperatur bei maximaler Drehzahl, 1 h Laufzeit und 20°C Raumtemperatur (nur bei Kühlzentrifuge)
- 2) Probenerwärmung bei maximaler Drehzahl und 1 Stunde Laufzeit (nur bei Zentrifuge ohne Kühlung)

- 1) Lowest possible temperature during maximum speed, 1 h running time and 20°C ambient temperature (only with cooling centrifuges)
- 2) Sample temp. rise during maximum speed and 1 hour running time (only with centrifuges without cooling)

1460	1453				1453 + 1485			
Ausschwingrotor 2-fach / Swing out rotor 2-times  								
	MTP	CP	MS	DWP	PCR-Platte, 96-fach PCR plate, 96 wells	PCR-Strips		
								
Kapazität / capacity	ml					0,2		
Maße / dimensions TxBxH / DxWxH	mm	86 x 128 x 15	86 x 128 x 22	86 x 128 x 46	86 x 128 x 44,5	82x124x20	---	
Anzahl p. Rotor / number p. rotor		10	8	2	2	2	24 x 8	
Drehzahl / speed	RPM	4000						
RZB / RCF		2218						
Radius / radius	mm	124						
 9 (97%)	sec	40						
 9	sec	45						
Temperatur / temperature	°C ¹⁾	- 6						
Probenerwärmung/Sample temp. rise	K ²⁾	11						

1628	1621			1122			1127		
Ausschwingrotor 12-fach / Swing out rotor 12-times   80° mit / with 1621  60° mit / with 1122  55° mit / with 1127									
	0507	0518			2079				
									
Kapazität / capacity	ml	15	7,5 – 8,2	8,5 - 10	10	4 – 5,5	4 – 7	5	1,6 – 5,0
Maße / dimensions Ø x L	mm	17 x 100	15 x 92	16 x 100	17 x 70	15 x 75	16 x 75	12/13 x 75	13 x 75
Anzahl p. Rotor / number p. rotor		12	12	12	12	12	12	12	12
Drehzahl / speed	RPM	5000							
RZB / RCF	³⁾	4193	4193	4193	3522	3522	3522	3466	3466
Radius / radius	mm	150	150	150	126	126	126	124	124
 9 (97%)	sec	16							
 9	sec	16							
Temperatur / temperature	°C ¹⁾	- 10							
Probenerwärmung/Sample temp. rise	K ²⁾	20							

- 1) Tiefste erreichbare Temperatur bei maximaler Drehzahl, 1 h Laufzeit und 20°C Raumtemperatur (nur bei Kühlzentrifuge)
- 2) Probenerwärmung bei maximaler Drehzahl und 1 Stunde Laufzeit (nur bei Zentrifuge ohne Kühlung)
- 3) Zentrifugiergefäße aus Glas nur belastbar bis RZB 4000









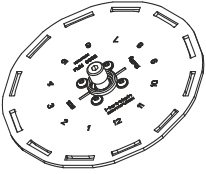

- 1) Lowest possible temperature during maximum speed, 1 h running time and 20°C ambient temperature (only with cooling centrifuges)
- 2) Sample temp. rise during maximum speed and 1 hour running time (only with centrifuges without cooling)
- 3) Centrifuge containers of glass will not stand RCF values exceeding 4000

MTP Mikrotiterplatte /
Microtitre plate

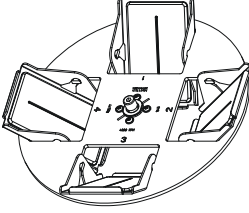
CP Kulturplatte /
Culture plate

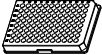
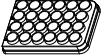
DWP Deep Well Platte /
Deep well plate

MS Micronic System /
Micronic system











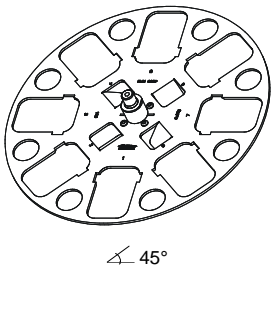

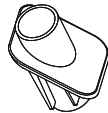

1628		1127 (50°)		1645		4345	
Ausschwingrotor 12-fach / Swing out rotor 12-times  		  		Ausschwingrotor 4-fach / Swing out rotor 4-times  		 MTP CP  	
Maße / dimensions Ø x L mm		11 x 66 13 x 65		Maße / dimensions TxBxH / DxWxH mm		86x128x15 86x128x22	
Anzahl p. Rotor / number p. rotor		12		Anzahl p. Rotor / number p. rotor		4	
Drehzahl / speed RPM		5000		Drehzahl / speed RPM		4000	
RZB / RCF		3466		RZB / RCF		1896	
Radius / radius mm		124		Radius / radius mm		106	
 9 (97%) sec		16		 9 (97%) sec		40	
 9 sec		16		 9 sec		43	
Temperatur / temperature °C ¹⁾		- 15		Temperatur / temperature °C ¹⁾		- 16	
Probenerwärmung/Sample temp. rise K ²⁾		14		Probenerwärmung/Sample temp. rise K ²⁾		17	











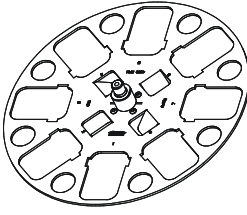

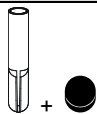
- 1) Tiefste erreichbare Temperatur bei maximaler Drehzahl, 1 h Laufzeit und 20°C Raumtemperatur (nur bei Kühlzentrifuge)
2) Probenerwärmung bei maximaler Drehzahl und 1 Stunde Laufzeit (nur bei Zentrifuge ohne Kühlung)

- 1) Lowest possible temperature during maximum speed, 1 h running time and 20°C ambient temperature (only with cooling centrifuges)
2) Sample temp. rise during maximum speed and 1 hour running time (only with centrifuges without cooling)

MTP Mikrotiterplatten /
Microtitre plate



CP Kulturplatte /
Culture plate







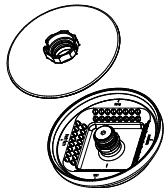
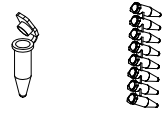



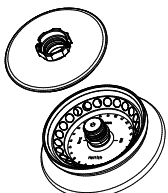

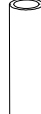

1418		1467				1468			
Winkelrotor 8-fach / Angle rotor 8-times  ∠ 45°									
		0716		E2109		E2110-A			
									
		0507	0518	---	0509	0546	---	0513	
									
Kapazität / capacity	ml	15	15	12	15	50	50	50	
Maße / dimensions	∅ x L	mm	17 x 100	17 x 100	17 x 100	17 x 120	29 x 107	29 x 115	29 x 115
Anzahl p. Rotor / number p. rotor		32	32	32	32	8	8	8	
Drehzahl / speed	RPM	4500	4500	4500	4500	4500	4500	4500	
RZB / RCF		3215	3215	3215	3283	3147	3147	3147	
Radius / radius	mm	142	142	142	145	139	139	139	
 9 (97%)	sec					30			
 9	sec					31			
Temperatur / temperature	°C ¹⁾					- 5			
Probenerwärmung/Sample temp. rise	K ²⁾					20			

1418		1467							
Winkelrotor 8-fach / Angle rotor 8-times  ∠ 45°									
		1054-A + 0701		1054-A					
									
									
Kapazität / capacity	ml	4	5	1,1 – 1,4	2,7 - 3	2,6 – 2,9	1,6 - 5	5	
Maße / dimensions	∅ x L	mm	12 x 60	12 x 75	8 x 66	11 x 66	13 x 65	13 x 75	13 x 75
Anzahl p. Rotor / number p. rotor		32	32	32	32	32	32	32	
Drehzahl / speed	RPM	4500	4500	4500	4500	4500	4500	4500	
RZB / RCF		2694	2762	2762	2762	2762	2762	2762	
Radius / radius	mm	119	122	122	122	122	122	122	
 (97%)	sec					30			
 1	sec					31			
Temperatur / temperature	°C ¹⁾					- 5			
Probenerwärmung/Sample temp. rise	K ²⁾					20			

1) Tiefste erreichbare Temperatur bei maximaler Drehzahl, 1 h Laufzeit und 20°C Raumtemperatur (nur bei Kühlzentrifuge)
 2) Probenerwärmung bei maximaler Drehzahl und 1 Stunde Laufzeit (nur bei Zentrifuge ohne Kühlung)











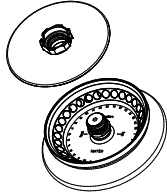
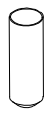

1) Lowest possible temperature during maximum speed, 1 h running time and 20°C ambient temperature (only with cooling centrifuges)
 2) Sample temp. rise during maximum speed and 1 hour running time (only with centrifuges without cooling)

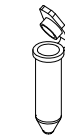
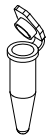







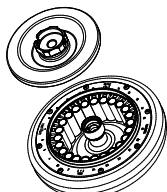

1551							
Winkelrotor 8-fach / Angle rotor 8-times  45° mit Bioabdichtung / with bio-containment 5)							
							
Kapazität / capacity	ml	0,2	0,2				
Maße / dimensions	∅ x L mm	6 x 18					
Anzahl p. Rotor / number p. rotor		64	8 x 8				
Drehzahl / speed	RPM	13000					
RZB / RCF		13604					
Radius / radius	mm	max. 72					
 9 (97%)	sec	36					
 9	sec	31					
Temperatur / temperature	°C ¹⁾	- 4					
Probenerwärmung/Sample temp. rise	K ²⁾	20					

1552								
Winkelrotor 24-fach / Angle rotor 24-times  50° mit Bioabdichtung / with bio-containment 5	---	8) 2031	2023	2024	2024	0788		
								
	0536	2078	---	---	---	---		
								
Kapazität / capacity	ml	2,0	1,5	0,8	0,5	0,2	0,4	0,5
Maße / dimensions	∅ x L mm	11 x 38	11 x 38	8 x 45	8 x 30	6 x 18	6 x 45	10,7 x 36
Anzahl p. Rotor / number p. rotor		24	24	24	24	24	24	12
Drehzahl / speed	RPM	16000						
RZB / RCF		24900						23755
Radius / radius	mm	87						83
 9 (97%)	sec	30						
 9	sec	29						
Temperatur / temperature	°C ¹⁾	2						
Probenerwärmung/sample temp. rise	K ¹⁴⁾	20						

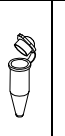
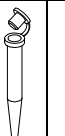
- 1) Tiefste erreichbare Temperatur bei maximaler Drehzahl, 1 h Laufzeit und 20°C Raumtemperatur (nur bei Kühlzentrifuge)
- 2) Probenerwärmung bei maximaler Drehzahl und 1 Stunde Laufzeit (nur bei Zentrifuge ohne Kühlung)
- 5) Nach DIN EN 61010, Teil 2 – 020. Die Hinweise für Bio-Sicherheitssysteme in den Kapiteln "Sicherheitshinweise" und "Pflege und Wartung" beachten
- 8) bei hochtouriger Zentrifugation empfohlen
- 9) Nur jeden zweiten Platz des Rotors beladen
- 14) Bei einer Laufzeit länger als 20 min. beträgt die Probenerwärmung > 20°K (nur bei Zentrifuge ohne Kühlung)

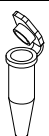
- 1) Lowest possible temperature during maximum speed, 1 h running time and 20°C ambient temperature (only with cooling centrifuges)
- 2) Sample temp. rise during maximum speed and 1 hour running time (only with centrifuges without cooling)
- 5) in conformity with DIN EN 61010, part 2 – 020. Observe the notes for bio safety systems in chapters "Notes on safety" and "Maintenance and servicing".
- 8) recommended for high-speed centrifugation
- 9) Load only each second position of the rotor
- 14) With running time longer than 20 min., the sample temp. rise up will be > 20°K (only with cooling centrifuges)

1553		8) 2031		2023		2024		0788	
Winkelrotor 30-fach / Angle rotor 30-times  45° mit Bioabdichtung / with bio-containment ⁵⁾	----								
	0536	2078						---	
									9)
Kapazität / capacity	ml	2,0	1,5	0,8	0,5	0,4	0,2	0,5	
Maße / dimensions	∅ x L	mm	11 x 38	11 x 38	8 x 45	8 x 30	6 x 45	6 x 18	10,7 x 36
Anzahl p. Rotor / number p. rotor		30	30	30	30	30	30	15	
Drehzahl / speed	RPM	14150	14150	14150	14150	14150	14150	14150	
RZB / RCF		21713	21713	21713	21713	21713	21713	20818	
Radius / radius	mm	97	97	97	97	97	97	93	
 9 (97%)	sec					35			
 9	sec					32			
Temperatur / temperature	°C ¹⁾					- 1			
Probenerwärmung/Sample temp. rise	K ¹⁵⁾					20			

1555		2024		2023		8) 2031					
Ausschwingrotor 24-fach / Swing out rotor 24-times  90° mit Bioabdichtung / with bio-containment ⁵⁾											
	---				2078	0536					
											
Kapazität / capacity	ml	0,2	0,4	0,5	0,8	1,5	2,0				
Maße / dimensions	∅ x L	mm	6 x 18	6 x 45	8 x 30	8 x 45	11 x 38	11 x 38			
Anzahl p. Rotor / number p. rotor						24					
Drehzahl / speed	RPM					13000					
RZB / RCF						18327					
Radius / radius	mm					97					
 9 (97%)	sec					36					
 9	sec					31					
Temperatur / temperature	°C ¹⁾					3					
Probenerwärmung/Sample temp. rise	K ¹⁰⁾					20					

1) Tiefste erreichbare Temperatur bei maximaler Drehzahl, 1 h Laufzeit und 20°C Raumtemperatur (nur bei Kühlzentrifuge)

5) Nach DIN EN 61010, Teil 2 – 020. Die Hinweise für Bio-Sicherheitssysteme in den Kapiteln "Sicherheitshinweise" und "Pflege und Wartung" beachten

8) bei hochtouriger Zentrifugation empfohlen

9) Nur jeden zweiten Platz des Rotors beladen

10) Bei einer Laufzeit länger als 10 min. beträgt die Probenerwärmung > 20°K (nur bei Zentrifuge ohne Kühlung)

15) Bei einer Laufzeit länger als 15 min. beträgt die Probenerwärmung > 20°K (nur bei Zentrifuge ohne Kühlung)

1) Lowest possible temperature during maximum speed, 1 h running time and 20°C ambient temperature (only with cooling centrifuges)











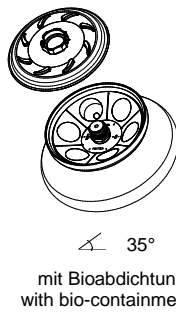
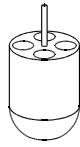

5) in conformity with DIN EN 61010, part 2 – 020. Observe the notes for bio safety systems in chapters "Notes on safety" and "Maintenance and servicing".



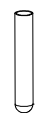
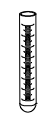

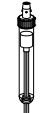





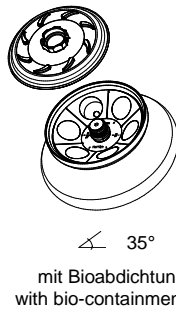



8) recommended for high-speed centrifugation

9) Load only each second position of the rotor

10) With running time longer than 10 min., the sample temp. rise up will be > 20°K (only with cooling centrifuges)

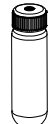
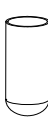









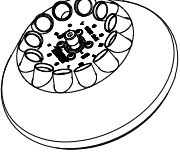

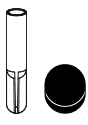
15) With running time longer than 15 min., the sample temp. rise up will be > 20°K (only with cooling centrifuges)











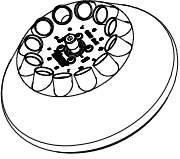

1556											
Winkelrotor 6-fach / Angle rotor 6-times  mit Bioabdichtung / with bio-containment ⁵⁾		1449		1477		1478					
											
				2078	0536	---	0507	0518			
											
Kapazität / capacity	ml	1,5	2,0	10	15	7,5 – 8,2	9 - 10	10	8,5 - 10		
Maße / dimensions	∅ x L mm	11 x 38	11 x 38	16 x 80	17 x 100	15 x 92	16 x 92	15 x 102	16 x 100		
Anzahl p. Rotor / number p. rotor		24	24	12	6						
Drehzahl / speed	RPM	9000									
RZB / RCF	³⁾	10324	10324	10414	10052						
Radius / radius	mm	114	114	115	111						
 9 (97%)	sec						36				
 9	sec						32				
Temperatur / temperature	°C ¹⁾	0									
Probenerwärmung/Sample temp. rise	K ²⁾	20									

1556												
Winkelrotor 6-fach / Angle rotor 6-times  mit Bioabdichtung / with bio-containment ⁵⁾		---		1466	1454	1447	1446	1463				
												
				0547	0539 / 538	0509	0513	0545	0546	0549	0548	0521
												
Kapazität / capacity	ml	85	94	15	50	30	50	85	50	50		
Maße / dimensions	∅ x L mm	38 x 106	38 x 102	17 x 120	29 x 115	26 x 95	29 x 107	38 x 101	35 x 105	34 x 100		
Anzahl p. Rotor / number p. rotor		6										
Drehzahl / speed	RPM	9000										
RZB / RCF	³⁾	10595	10052		9690	10142	10595	10414				
Radius / radius	mm	117	111		107	112	117	115				
 9 (97%)	sec						36					
 9	sec						32					
Temperatur / temperature	°C ¹⁾	0										
Probenerwärmung/Sample temp. rise	K ²⁾	20										

1) Tiefste erreichbare Temperatur bei maximaler Drehzahl, 1 h Laufzeit und 20°C Raumtemperatur (nur bei Kühlzentrifuge)
 2) Probenerwärmung bei maximaler Drehzahl und 1 Stunde Laufzeit (nur bei Zentrifuge ohne Kühlung)
 3) Zentrifugiergefäße aus Glas nur belastbar bis RZB 4000
 5) Nach DIN EN 61010, Teil 2 – 020. Die Hinweise für Bio-Sicherheitssysteme in den Kapiteln "Sicherheitshinweise" und "Pflege und Wartung" beachten









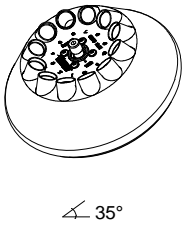

1) Lowest possible temperature during maximum speed, 1 h running time and 20°C ambient temperature (only with cooling centrifuges)
 2) Sample temp. rise during maximum speed and 1 hour running time (only with centrifuges without cooling)
 3) Centrifuge containers of glass will not stand RCF values exceeding 4000
 5) in conformity with DIN EN 61010, part 2 – 020. Observe the notes for bio safety systems in chapters "Notes on safety" and "Maintenance and servicing".











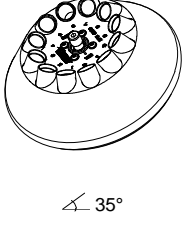

1613		1054-A					1054-A / 0701			
Winkelrotor 12-fach / Angle rotor 12-times  35°										
		---		0501						
										
Kapazität / capacity	ml	5	1,6 – 5,0	6	2,6 – 2,9	2,7 – 3	1,1 – 1,4	4	8,5 - 10	8
Maße / dimensions	∅ x L mm	12/13 x 75	13 x 75	12 x 82	13 x 65	11 x 66	8 x 66	12 x 60	16 x 100	16 x 125
Anzahl p. Rotor / number p. rotor		12	12	12	12		12	12	12	6
Drehzahl / speed	RPM	6000	6000	6000	6000		6000	6000	6000	6000
RZB / RCF		3300	3300	3300	3300		3300	3260	4146	4146
Radius / radius	mm	82	82	82	82		82	81	103	103
 9 (97%)	sec	15								
 9	sec	15								
Temperatur / temperature	°C ¹⁾	- 16								
Probenerwärmung/Sample temp. rise	K ²⁾	4								

1613		SK 19/85-4								
Winkelrotor 12-fach / Angle rotor 12-times  35°										
										
Kapazität / capacity	ml	4,5 - 5	4,9	7,5 – 8,2	9 – 10	10	4 – 5,5	1,6 - 5	4 - 7	
Maße / dimensions	∅ x L mm	11 x 92	13 x 90	15 x 92	16 x 92	15 x 102	15 x 75	13 x 75	16 x 75	
Anzahl p. Rotor / number p. rotor		12	12	12	12	12	12	12	12	
Drehzahl / speed	RPM	6000	6000	6000	6000	6000	6000	6000	6000	
RZB / RCF		4146	4146	4146	4146	4146	3663	3663	3663	
Radius / radius	mm	103	103	103	103	103	91	91	91	
 9 (97%)	sec	15								
 9	sec	15								
Temperatur / temperature	°C ¹⁾	- 16								
Probenerwärmung/Sample temp. rise	K ²⁾	4								

1) Tiefste erreichbare Temperatur bei maximaler Drehzahl, 1 h Laufzeit und 20°C Raumtemperatur (nur bei Kühlzentrifuge)
 2) Probenerwärmung bei maximaler Drehzahl und 1 Stunde Laufzeit (nur bei Zentrifuge ohne Kühlung)

1) Lowest possible temperature during maximum speed, 1 h running time and 20°C ambient temperature (only with cooling centrifuges)
 2) Sample temp. rise during maximum speed and 1 hour running time (only with centrifuges without cooling)

1613									
Winkelrotor 12-fach / Angle rotor 12-times  35°						6305	1063		
						SK 1/89			
			0507	0518	0509	---			
									
Kapazität / capacity	ml	4 – 7	15	15	0,8	4	0,5		
Maße / dimensions	Ø x L mm	13 x 100	17 x 100	17 x 120	8 x 45	10 x 88	11 x 38		
Anzahl p. Rotor / number p. rotor		12	12	6	12	12	12		
Drehzahl / speed	RPM	6000	6000	6000	6000	6000	6000		
RZB / RCF	³⁾	4146	4146	4146	2576	3502	2777		
Radius / radius	mm	103	103	103	64	87	69		
 9 (97%)	sec					15			
 9	sec					15			
Temperatur / temperature	°C ¹⁾					- 16			
Probenerwärmung/Sample temp. rise	K ²⁾					4			

1615		1054-A				1054-A /0701				
Winkelrotor 12-fach / Angle rotor 12-times  35°										
		---	0501							
										
Kapazität / capacity	ml	5	1,6 – 5	6	2,6 – 2,9	2,7 x 3	1,1 – 1,4	4	8,5 - 10	8
Maße / dimensions	Ø x L mm	12/13 x 75	13 x 75	12 x 82	13 x 65	11 x 66	8 x 66	12 x 60	16 x 100	16 x 125
Anzahl p. Rotor / number p. rotor		12	12	12	12		12	12	12	6
Drehzahl / speed	RPM	12000	12000	12000	12000	12000	12000	12000	12000	12000
RZB / RCF	³⁾	13201	13201	13201	13201	13201	13201	13040	16582	16582
Radius / radius	mm	82	82	82	82	82	82	81	103	103
 9 (97%)	sec					40				
 9	sec					40				
Temperatur / temperature	°C ¹⁾					- 2				
Probenerwärmung/Sample temp. rise	K ²⁾					14				

- 1) Tiefste erreichbare Temperatur bei maximaler Drehzahl, 1 h Laufzeit und 20°C Raumtemperatur (nur bei Kühlzentrifuge)
- 2) Probenerwärmung bei maximaler Drehzahl und 1 Stunde Laufzeit (nur bei Zentrifuge ohne Kühlung)
- 3) Zentrifugiergefäße aus Glas nur belastbar bis RZB 4000

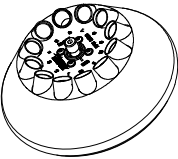

- 1) Lowest possible temperature during maximum speed, 1 h running time and 20°C ambient temperature (only with cooling centrifuges)
- 2) Sample temp. rise during maximum speed and 1 hour running time (only with centrifuges without cooling)
- 3) Centrifuge containers of glass will not stand RCF values exceeding 4000

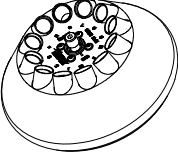

1615										
Winkelrotor 12-fach / Angle rotor 12-times  ∠ 35°								SK 19/85-4		
Kapazität / capacity	ml	4,5 - 5	4,9	7,5 – 8,2	9 – 10	10	4 – 5,5	1,6 - 5	4 - 7	
Maße / dimensions	∅ x L mm	11 x 92	13 x 90	15 x 92	16 x 92	15 x 102	15 x 75	13 x 75	16 x 75	
Anzahl p. Rotor / number p. rotor		12	12	12	12	12	12	12	12	
Drehzahl / speed	RPM	12000	12000	12000	12000	12000	12000	12000	12000	
RZB / RCF		16582	16582	16582	16582	16582	14650	14650	14650	
Radius / radius	mm	103	103	103	103	103	91	91	91	
9 (97%)	sec						40			
9	sec						40			
0	sec						840			
Temperatur / temperature	°C ¹⁾						- 2			
Probenerwärmung/Sample temp. rise	K ²⁾						14			

1615						6305	1063			
Winkelrotor 12-fach / Angle rotor 12-times  ∠ 35°										
Kapazität / capacity	ml	4 - 7	15	15	0,8	4	0,5			
Maße / dimensions	∅ x L mm	13 x 100	17 x 100	17 x 120	8 x 45	10 x 88	11 x 38			
Anzahl p. Rotor / number p. rotor		12	12	6	12	12	12			
Drehzahl / speed	RPM	12000	12000	12000	12000	12000	12000			
RZB / RCF	³⁾	16582	16582	16582	10303	14006	11108			
Radius / radius	mm	103	103	103	64	87	69			
9 (97%)	sec						40			
9	sec						40			
Temperatur / temperature	°C ¹⁾						- 2			
Probenerwärmung/Sample temp. rise	K ²⁾						14			

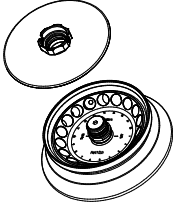
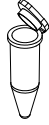
1) Tiefste erreichbare Temperatur bei maximaler Drehzahl, 1 h Laufzeit und 20°C Raumtemperatur (nur bei Kühlzentrifuge)
 2) Probenerwärmung bei maximaler Drehzahl und 1 Stunde Laufzeit (nur bei Zentrifuge ohne Kühlung)
 3) Zentrifugiergefäße aus Glas nur belastbar bis RZB 4000



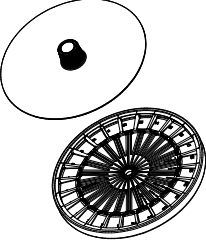







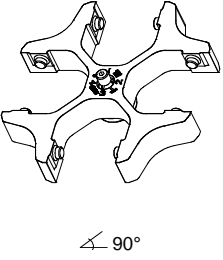
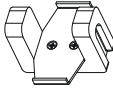

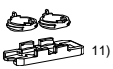
1) Lowest possible temperature during maximum speed, 1 h running time and 20°C ambient temperature (only with cooling centrifuges)
 2) Sample temp. rise during maximum speed and 1 hour running time (only with centrifuges without cooling)
 3) Centrifuge containers of glass will not stand RCF values exceeding 4000











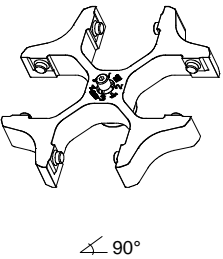
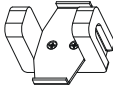
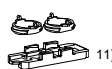

1627							
Winkelrotor 18-fach / Angle rotor 18-times  <p>45° mit Bioabdichtung / with bio-containment ⁵⁾</p> 							
Kapazität / capacity	ml	5					
Maße / dimensions	∅ x L	mm	17 x 59				
Anzahl p. Rotor / number p. rotor		18					
Drehzahl / speed	RPM	14150					
RZB / RCF	³⁾	22161					
Radius / radius	mm	99					
 9 (97%)	sec	35					
 9	sec	32					
Temperatur / temperature	°C ¹⁾	2					
Probenerwärmung/Sample temp. rise	K ¹⁰⁾	20					

1650-A							
Hämatokritrotor 24-fach / Haematocrite rotor 24-times 							
Kapazität / capacity	ml						
Maße / dimensions	∅ x L	mm	1,4 x 75				
Anzahl p. Rotor / number p. rotor		24					
Drehzahl / speed	RPM	14150					
RZB / RCF		19027					
Radius / radius	mm	85					
 9 (97%)	sec	35					
 9	sec	32					
Temperatur / temperature	°C ¹⁾	- 3					
Probenerwärmung/Sample temp. rise	K ¹⁰⁾	20					

1) Tiefste erreichbare Temperatur bei maximaler Drehzahl, 1 h Laufzeit und 20°C Raumtemperatur (nur bei Kühlzentrifuge)
 3) Zentrifugiergefäße aus Glas nur belastbar bis RZB 4000
 5) Nach DIN EN 61010, Teil 2 – 020. Die Hinweise für Bio-Sicherheitssysteme in den Kapiteln "Sicherheitshinweise" und "Pflege und Wartung" beachten
 10) Bei einer Laufzeit länger als 10 min. beträgt die Probenerwärmung > 20°K (nur bei Zentrifuge ohne Kühlung)











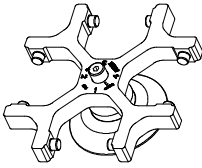

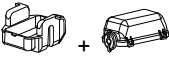

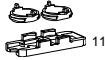
1) Lowest possible temperature during maximum speed, 1 h running time and 20°C ambient temperature (only with cooling centrifuges)
 3) Centrifuge containers of glass will not stand RCF values exceeding 4000
 5) in conformity with DIN EN 61010, part 2 – 020. Observe the notes for bio safety systems in chapters "Notes on safety" and "Maintenance and servicing".
 10) With running time longer than 10 min., the sample temp. rise up will be > 20°K (only with cooling centrifuges)











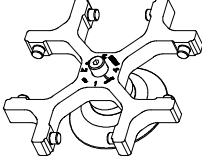





1494		1452							
Ausschwingrotor 4-fach / Swing out rotor 4-times  ↙ 90°									
		1662 						1670  11)	
		1663 	1664 	1665 	1666 	1667 	1668 	1663 	1664 
Kapazität / capacity	ml	1	2	4	8	3 x 2	4 x 1	1	2
Maße / dimensions Ø / A	mm ²	6,2 / 30	8,7 / 60	12,4 / 120	17,5 / 240	8,7 / 60	6,2 / 30	6,2 / 30	8,7 / 60
Anzahl p. Rotor / number p. rotor		4	4	4	4	4	4	4	4
Filterkarten / filter cards		1675	1675	1675	1676	1677	1678	1692	1692
Drehzahl / speed	RPM	5000							
RZB / RCF		2879							
Radius / radius	mm	103							
 9 (97%)	sec	30							
 9	sec	32							
Temperatur / temperature	°C ¹⁾	- 10							
Probenerwärmung/Sample temp. rise	K ²⁾	12							

1494		1452								
Ausschwingrotor 4-fach / Swing out rotor 4-times  ↙ 90°										
		1670  11)				1285 	1470 			
		1665 	1666 	1667 	1668 		1471 	1475 		
Kapazität / capacity	ml	4	8	3 x 2	4 x 1	Objektträger/ object slide	1 x 8	2 x 8		
Maße / dimensions Ø / A	mm ²	12,4 / 120	17,5 / 240	8,7 / 60	6,2 / 30	26 / 76	17,5 / 240	17,5 / 240		
Anzahl p. Rotor / number p. rotor		4	4	4	4	24	4	4		
Filterkarten / filter cards		1692	1691	1694	1693	---	---	---		
Drehzahl / speed	RPM	5000	5000	5000	5000	5000	5000	5000		
RZB / RCF		2879	2879	2879	2879	2767	2739	2739		
Radius / radius	mm	103	103	103	103	99	98	98		
 9 (97%)	sec	30								
 9	sec	32								
Temperatur / temperature	°C ¹⁾	- 10								
Probenerwärmung/Sample temp. rise	K ²⁾	12								

1) Tiefste erreichbare Temperatur bei maximaler Drehzahl, 1 h Laufzeit und 20°C Raumtemperatur (nur bei Kühlzentrifuge)
 2) Probenerwärmung bei maximaler Drehzahl und 1 Stunde Laufzeit (nur bei Zentrifuge ohne Kühlung)
 11) Objektträger nur belastbar bis RZB 1100

1) Lowest possible temperature during maximum speed, 1 h running time and 20°C ambient temperature (only with cooling centrifuges)
 2) Sample temp. rise during maximum speed and 1 hour running time (only with centrifuges without cooling)
 11) Object slide will not stand RCF values exceeding 1100

1624		1660 + 1661							
Ausschwingrotor 4-fach / Swing out rotor 4-times   90°									
		1662 						1670  ¹¹⁾	
		1663	1664	1665	1666	1667	1668	1663	1664
									
Kapazität / capacity	ml	1	2	4	8	3 x 2	4 x 1	1	2
Maße / dimensions \varnothing / A	mm ²	6,2 / 30	8,7 / 60	12,4 / 120	17,5 / 240	8,7 / 60	6,2 / 30	6,2 / 30	8,7 / 60
Anzahl p. Rotor / number p. rotor		4	4	4	4	4	4	4	4
Filterkarten / filter cards		1675	1675	1675	1676	1677	1678	1692	1692
Drehzahl / speed	RPM	4000							
RZB / RCF		1646							
Radius / radius	mm	92							
 9 (97%)	sec	20							
 9	sec	25							
Temperatur / temperature	°C ¹⁾	- 16							
Probenerwärmung/Sample temp. rise	K ²⁾	3							

1624		1660 + 1661				1660	1680			
Ausschwingrotor 4-fach / Swing out rotor 4-times   90°										
		1670  ¹¹⁾					1285  nur ohne Deckel 1661 / only without lid1661	1662 		
		1665	1666	1667	1668		1671	1672	1673	
										
Kapazität / capacity	ml	4	8	3 x 2	4 x 1	Objektträger Object slide	[1] 0,5	[1] 0,5	[1] 0,5	
Maße / dimensions \varnothing / A	mm ²	12,4 / 120	17,5 / 240	8,7 / 60	6,2 / 30	26 / 76	6,2 / 30	8,7 / 60	12,4 / 120	
Anzahl p. Rotor / number p. rotor		4	4	4	4	24	4	4	4	
Filterkarten / filter cards		1692	1691	1694	1693	---	[1] 1696	[1] 1697	[1] 1698	
Drehzahl / speed	RPM	4000	4000	4000	4000	4000	4000	4000	4000	
RZB / RCF		1646	1646	1646	1646	1520	1467	1467	1467	
Radius / radius	mm	92	92	92	92	88	82	82	82	
 9 (97%)	sec	20								
 9	sec	25								
 0	sec	390								
Temperatur / temperature	°C ¹⁾	- 16								
Probenerwärmung/Sample temp. rise	K ²⁾	3								

1) Tiefste erreichbare Temperatur bei maximaler Drehzahl, 1 h Laufzeit und 20°C Raumtemperatur (nur bei Kühlzentrifuge)

2) Probenerwärmung bei maximaler Drehzahl und 1 Stunde Laufzeit (nur bei Zentrifuge ohne Kühlung)

11) Objektträger nur belastbar bis RZB 1100









[1] Einschritt-Methode

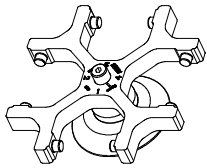

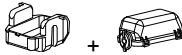







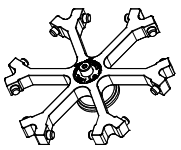

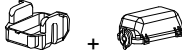

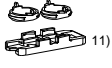
1) Lowest possible temperature during maximum speed, 1 h running time and 20°C ambient temperature (only with cooling centrifuges)

2) Sample temp. rise during maximum speed and 1 hour running time (only with centrifuges without cooling)

11) Object slide will not stand RCF values exceeding 1100











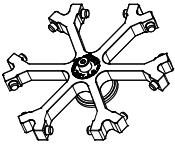

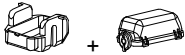

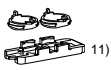



[1] One-step method











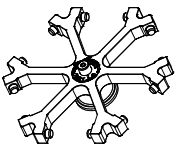

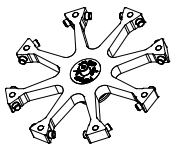



1624		1660 + 1661								
Ausschwingrotor 4-fach / Swing out rotor 4-times  										
		1470 								
		1471	1475							
										
Kapazität / capacity	ml	1 x 8	2 x 8							
Maße / dimensions Ø / A	mm ²	17,5 / 240	17,5 / 240							
Anzahl p. Rotor / number p. rotor		4	4							
Filterkarten / filter cards		---	---							
Drehzahl / speed	RPM	4000	4000							
RZB / RCF		1556	1556							
Radius / radius	mm	87	87							
 9 (97%)	sec	20								
 9	sec	25								
 0	sec	390								
Temperatur / temperature	°C ¹⁾	- 16								
Probenerwärmung/Sample temp. rise	K ²⁾	3								

1626		1660 + 1661							
Ausschwingrotor 6-fach / Swing out rotor 6-times  									
		1662 						1670  ¹¹⁾	
		1663	1664	1665	1666	1667	1668	1663	1664
									
Kapazität / capacity	ml	1	2	4	8	3 x 2	4 x 1	1	2
Maße / dimensions Ø / A	mm ²	6,2 / 30	8,7 / 60	12,4 / 120	17,5 / 240	8,7 / 60	6,2 / 30	6,2 / 30	8,7 / 60
Anzahl p. Rotor / number p. rotor		6	6	6	6	6	6	6	6
Filterkarten / filter cards		1675	1675	1675	1676	1677	1678	1692	1692
Drehzahl / speed	RPM	4000							
RZB / RCF		2039							
Radius / radius	mm	114							
 9 (97%)	sec	20							
 9	sec	22							
Temperatur / temperature	°C ¹⁾	- 16							
Probenerwärmung/Sample temp. rise	K ²⁾	7							

1) Tiefste erreichbare Temperatur bei maximaler Drehzahl, 1 h Laufzeit und 20°C Raumtemperatur (nur bei Kühlzentrifuge)
 2) Probenerwärmung bei maximaler Drehzahl und 1 Stunde Laufzeit (nur bei Zentrifuge ohne Kühlung)
 11) Objektträger nur belastbar bis RZB 1100









1) Lowest possible temperature during maximum speed, 1 h running time and 20°C ambient temperature (only with cooling centrifuges)
 2) Sample temp. rise during maximum speed and 1 hour running time (only with centrifuges without cooling)
 11) Object slide will not stand RCF values exceeding 1100

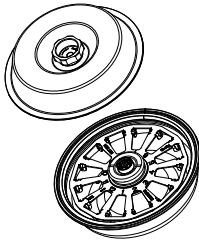
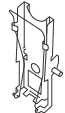
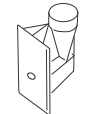
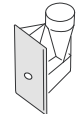
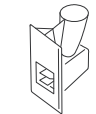
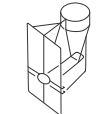
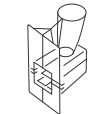





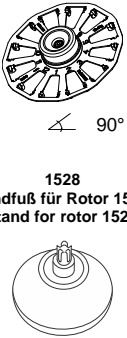
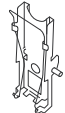
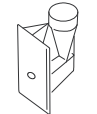
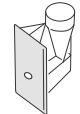
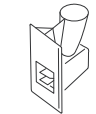
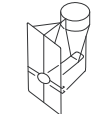
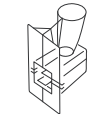

1626		1660 + 1661				1660	1680			
Ausschwingrotor 6-fach / Swing out rotor 6-times  										
										1670
						 nur ohne Deckel 1661 / only without lid 1661				
		1665	1666	1667	1668		1671	1672	1673	
										
Kapazität / capacity	ml	4	8	3 x 2	4 x 1	Objektträger Object slide	[1] 0,5	[1] 0,5	[1] 0,5	
Maße / dimensions Ø / A	mm ²	12,4 / 120	17,5 / 240	8,7 / 60	6,2 / 30	26 / 76	6,2 / 30	8,7 / 60	12,4 / 120	
Anzahl p. Rotor / number p. rotor		6	6	6	6	36	6	6	6	
Filterkarten / filter cards		1692	1691	1694	1693	---	[1] 1696	[1] 1697	[1] 1698	
Drehzahl / speed	RPM	4000	4000	4000	4000	4000	4000	4000	4000	
RZB / RCF		2039	2039	2039	2039	1914	1842	1842	1842	
Radius / radius	mm	114	114	114	114	107	103	103	103	
 9 (97%)	sec					20				
 9	sec					22				
 0	sec					330				
Temperatur / temperature	°C ¹⁾					- 16				
Probenerwärmung/Sample temp. rise	K ²⁾					7				

1626		1660 + 1661		1648		1680						
Ausschwingrotor 6-fach / Swing out rotor 6-times  				Ausschwingrotor 8-fach / Swing out rotor 8-times  								
									1470		1662	
												
											1672	1673
Kapazität / capacity	ml	1 x 8	2 x 8	Kapazität / capacity	ml	[1] 0,5	[1] 0,5	[1] 0,5				
Maße / dimensions Ø x L	mm	17,5 / 240	17,5 / 240	Maße / dimensions Ø x L	mm	6,2 / 30	8,7 / 60	12,4 / 120				
Anzahl p. Rotor / number p. rotor		6	6	Anzahl p. Rotor / number p. rotor		8	8	8				
Filterkarten / filter cards		---	---	Filterkarten / filter cards		[1] 1696	[1] 1697	[1] 1698				
Drehzahl / speed	RPM	4000		Drehzahl / speed	RPM	4000						
RZB / RCF		1950		RZB / RCF		2218						
Radius / radius	mm	109		Radius / radius	mm	124						
 9 (97%)	sec	20		 9 (97%)	sec	20						
 9	sec	22		 9	sec	17						
Temperatur / temperature	°C ¹⁾	- 16		Temperatur / temperature	°C ¹⁾	- 16						
Probenerwärmung/Sample temp. rise	K ²⁾	7		Probenerwärmung/Sample temp. rise	K ²⁾	13						

1) Tiefste erreichbare Temperatur bei maximaler Drehzahl, 1 h Laufzeit und 20°C Raumtemperatur (nur bei Kühlzentrifuge)
 2) Probenerwärmung bei maximaler Drehzahl und 1 Stunde Laufzeit (nur bei Zentrifuge ohne Kühlung)
 11) Objektträger nur belastbar bis RZB 1100
 [1] Einschritt-Methode

1) Lowest possible temperature during maximum speed, 1 h running time and 20°C ambient temperature (only with cooling centrifuges)
 2) Sample temp. rise during maximum speed and 1 hour running time (only with centrifuges without cooling)
 11) Object slide will not stand RCF values exceeding 1100
 [1] One-step method

1515-A		1524						
<p>Rotor 12-fach</p>  <p>∠ 90°</p>								
		1531 / 1534 ¹²⁾	1532 ¹²⁾	1535 / 1533 ¹²⁾	1538 ¹²⁾	1536 ¹²⁾		
								
					1539 ¹²⁾	1537 ¹²⁾		
								
Kapazität / capacity	ml	0,5	0,2	6 ¹³⁾	0,5	6 ¹³⁾		
Maße / dimensions Ø / A	mm ²	6 / 28,3	6 / 28,3	-	6 / 28,3	-		
Maße (L x B) / dimensions (L x W)	mm	-	-	13,4 x 22	-	13,4 x 22		
Anzahl p. Rotor / number p. rotor		12						
Drehzahl / speed	RPM	2000						
RZB / RCF		438						
Radius / radius	mm	98						
 9 (97%)	sec	19						
 9	sec	18						
Temperatur / temperature	°C ¹⁾	- 10						
Probenerwärmung/sample temp. rise	K ²⁾	3						

1520		1524						
<p>Rotor 12-fach</p>  <p>∠ 90°</p> <p>1528 Standfuß für Rotor 1520 / stand for rotor 1520</p>								
		1531 / 1534 ¹²⁾	1532 ¹²⁾	1535 / 1533 ¹²⁾	1538 ¹²⁾	1536 ¹²⁾		
								
					1539 ¹²⁾	1537 ¹²⁾		
								
Kapazität / capacity	ml	0,5	0,2	6 ¹³⁾	0,5	6 ¹³⁾		
Maße / dimensions Ø / A	mm ²	6 / 28,3	6 / 28,3	-	6 / 28,3	-		
Maße (L x B) / dimensions (L x W)	mm	-	-	13,4 x 22	-	13,4 x 22		
Anzahl p. Rotor / number p. rotor		12						
Drehzahl / speed	RPM	2000						
RZB / RCF		438						
Radius / radius	mm	98						
 9 (97%)	sec	19						
 9	sec	18						
Temperatur / temperature	°C ¹⁾	- 10						
Probenerwärmung/sample temp. rise	K ²⁾	3						

- 1) Tiefste erreichbare Temperatur bei maximaler Drehzahl, 1 h Laufzeit und 20°C Raumtemperatur (nur bei Kühlzentrifuge)
 2) Probenerwärmung bei maximaler Drehzahl und 1 Stunde Laufzeit (nur bei Zentrifuge ohne Kühlung)

- 1) Lowest possible temperature during maximum speed, 1 h running time and 20°C ambient temperature (only with cooling centrifuges)
 2) Sample temp. rise during maximum speed and 1 hour running time (only with centrifuges without cooling)

12)	Bestell-Nr. / Cat. No.	Menge / Quantity	Bestell-Nr. / Cat. No.	Menge / Quantity
	1531, 1532	50 St. / 50 pcs.	1536, 1538	12 St. / 12 pcs.
	1533, 1534	500 St. / 500 pcs.	1539	200 St. / 200 pcs.
	1535, 1537	100 St. / 100 pcs.		

- 13) Dies ist das maximale Fassungsvermögen, die empfohlene Füllmenge der Kammern beträgt 4 ml.

- 13) This is the maximum capacity. The recommended quantity to be used per chamber is 4 ml.