



Sigma 6-16S

from serial no. 147414



Laboratory Centrifuge

Operating Manual

Please retain for later use!

In case of inquiries, please state the following numbers:

Order number:

Serial number:

© Copyright by
Sigma Laborzentrifugen GmbH
An der Unteren Söse 50
37520 Osterode am Harz
Germany

Tel.: +49 (0) 5522 / 5007-0
Fax: +49 (0) 5522 / 5007-12
Web: www.sigma-zentrifugen.de
E-mail: info@sigma-zentrifugen.de

Table of contents

| | | |
|----------|---|-----------|
| 1 | General information | 9 |
| 1.1 | Importance of the operating manual..... | 9 |
| 1.2 | Intended use..... | 9 |
| 1.3 | Warranty and liability..... | 9 |
| 1.4 | Copyright..... | 10 |
| 1.5 | Standards and regulations..... | 10 |
| 1.6 | Scope of Supply..... | 10 |
| 2 | Layout and mode of operation | 11 |
| 2.1 | Layout of the centrifuge..... | 11 |
| 2.1.1 | Functional and operating elements..... | 11 |
| 2.1.2 | Name plate..... | 12 |
| 2.2 | Mode of operation..... | 13 |
| 2.2.1 | Centrifugation principle..... | 13 |
| 2.2.2 | Area of application..... | 13 |
| 2.2.2.1 | Speed, radius, and relative centrifugal force..... | 14 |
| 2.2.2.2 | Density..... | 14 |
| 3 | Safety | 15 |
| 3.1 | Marking of the unit..... | 15 |
| 3.2 | Explanation of the symbols and notes..... | 16 |
| 3.3 | Responsibility of the operator..... | 17 |
| 3.4 | Operating personnel..... | 17 |
| 3.5 | Informal safety instructions..... | 17 |
| 3.6 | Safety instructions..... | 18 |
| 3.6.1 | Electrical safety..... | 18 |
| 3.6.2 | Mechanical safety..... | 18 |
| 3.6.3 | Fire prevention..... | 19 |
| 3.6.4 | Chemical and biological safety..... | 19 |
| 3.6.5 | Safety instructions for centrifugation..... | 20 |
| 3.6.6 | Resistance of plastics..... | 20 |
| 3.6.7 | Service life of rotors and accessories..... | 21 |
| 3.7 | Safety devices..... | 22 |
| 3.7.1 | Lid lock device..... | 22 |
| 3.7.2 | Standstill monitoring system..... | 22 |
| 3.7.3 | System check..... | 22 |
| 3.7.4 | Earth conductor check..... | 22 |
| 3.7.5 | Imbalance monitoring system..... | 22 |
| 3.7.6 | Rotor monitoring system..... | 22 |
| 3.8 | Measures in the event of hazards and accidents..... | 23 |
| 3.9 | Remaining hazards..... | 23 |

Table of contents

| | | |
|----------|---|-----------|
| 4 | Storage and transport | 24 |
| 4.1 | Dimensions and weight..... | 24 |
| 4.2 | Storage conditions | 24 |
| 4.3 | Notes on transport | 24 |
| 4.4 | Packaging..... | 25 |
| 4.5 | Transport safety device..... | 25 |
| 5 | Set-up and connection | 26 |
| 5.1 | Installation site | 26 |
| 5.2 | Power supply | 26 |
| 5.2.1 | Type of connection | 26 |
| 5.2.2 | Customer-provided fuses..... | 26 |
| 6 | Using the centrifuge | 27 |
| 6.1 | Initial start-up | 27 |
| 6.2 | Switching the centrifuge on | 27 |
| 6.2.1 | Opening and closing the lid..... | 27 |
| 6.2.2 | Installation of rotors and accessories..... | 27 |
| 6.2.2.1 | Installation of the rotor..... | 27 |
| 6.2.2.2 | Installation of angle rotors with a hermetically sealed lid | 28 |
| 6.2.2.3 | Installation of accessories | 29 |
| 6.2.2.4 | Adapters | 30 |
| 6.2.2.5 | Tubes..... | 31 |
| 6.2.2.6 | Blood bag systems..... | 31 |
| 6.2.2.7 | Centrifugation with tubes for mineral oil | 32 |
| 6.3 | Control system "Spincontrol S" | 33 |
| 6.3.1 | User interface | 33 |
| 6.3.2 | Manual mode..... | 34 |
| 6.3.2.1 | Starting a centrifugation run | 34 |
| 6.3.2.2 | Interrupting a centrifugation run | 34 |
| 6.3.2.3 | Interrupting a deceleration process | 34 |
| 6.3.2.4 | Selection, display, and modification of data..... | 34 |
| 6.3.2.5 | Standard menu | 35 |
| 6.3.2.6 | Process library menu | 39 |
| 6.3.2.7 | Parameters menu | 40 |
| 6.3.2.8 | Setup menu | 43 |
| 6.3.2.9 | Curve menu | 46 |
| 6.3.2.10 | Help menu | 47 |
| 6.3.2.11 | Changing the contrast..... | 48 |

Table of contents

| | | |
|-----------|--|-----------|
| 6.3.3 | Program mode..... | 48 |
| 6.3.3.1 | Saving a program..... | 49 |
| 6.3.3.2 | Loading a program..... | 49 |
| 6.3.3.3 | Executing a program..... | 50 |
| 6.3.3.4 | Deleting a program..... | 50 |
| 6.3.3.5 | Automatic program rotation..... | 51 |
| 6.3.4 | Options for data input and output..... | 52 |
| 6.4 | Switching the centrifuge off..... | 52 |
| 7 | Malfunctions and error correction..... | 53 |
| 7.1 | General malfunctions..... | 53 |
| 7.1.1 | Emergency lid release..... | 54 |
| 7.2 | Table of error codes..... | 55 |
| 7.3 | Service contact..... | 56 |
| 8 | Maintenance and service..... | 57 |
| 8.1 | Maintenance..... | 57 |
| 8.1.1 | Centrifuge..... | 57 |
| 8.1.2 | Accessories..... | 58 |
| 8.1.2.1 | Plastic accessories..... | 58 |
| 8.1.3 | Rotors, buckets and carriers..... | 59 |
| 8.1.4 | Load bearing bolts..... | 59 |
| 8.1.5 | Glass breakage..... | 60 |
| 8.2 | Sterilisation and disinfection of the rotor chamber and accessories..... | 60 |
| 8.2.1 | Autoclaving..... | 61 |
| 8.3 | Service..... | 62 |
| 8.4 | Return of defective parts..... | 63 |
| 9 | Disposal..... | 65 |
| 9.1 | Disposal of the centrifuge..... | 65 |
| 9.2 | Disposal of the packaging..... | 65 |
| 10 | Technical data..... | 66 |
| 10.1 | Ambient conditions..... | 66 |
| 10.2 | Technical documentation..... | 67 |
| 11 | Appendix..... | 68 |
| 11.1 | Range of accessories..... | 68 |
| 11.1.1 | Maximum speed for tubes..... | 72 |
| 11.1.2 | Rotor radii..... | 72 |
| 11.2 | Speed-gravitational-field-diagram..... | 73 |
| 11.3 | Acceleration and deceleration curves..... | 74 |
| 11.4 | Table of the service life of rotors and accessories..... | 76 |
| 11.5 | Resistance data..... | 77 |
| 11.6 | EC declaration of conformity..... | 81 |
| 12 | Index..... | 83 |

Table of contents

1 General information

1.1 Importance of the operating manual

A fundamental requirement for the safe and trouble-free operation of the centrifuge is to be familiar with the fundamental safety instructions and all possible hazards.

The operating manual includes important information concerning the safe operation of the centrifuge.

This operating manual and, in particular, the notes on safety and hazards must be observed by all persons operating the centrifuge.

In addition, the local rules and regulations for the prevention of accidents must be complied with.

1.2 Intended use

Centrifuges are power-driven machines that separate liquids from solid matter, liquid mixtures, or solid mixtures by centrifugal force. They are solely intended for this purpose. Any other use beyond this area of application is regarded as improper use. Sigma Laborzentrifugen GmbH cannot be held liable for any damage resulting from such improper use.

The intended use also includes

- observation of all the notes and instructions included in the operating manual and
- compliance with the care, cleaning, and maintenance instructions.

1.3 Warranty and liability

The warranty and liability are subject to our "General Conditions" that were distributed to the operator upon the conclusion of the contract.

Warranty and liability claims are excluded if they are due to:

- improper use.
- non-compliance with the safety instructions and hazard warnings in the operating manual.
- improper installation, start-up, operation, or maintenance of the centrifuge.

1 General information

1.4 Copyright

The copyright concerning the operating manual remains with Sigma Laborzentrifugen GmbH.

The operating manual is solely intended for the operator and their personnel. It includes instructions and information that must not be

- duplicated,
- distributed, or
- communicated in any other way.

Non-compliance may be prosecuted under criminal law.

1.5 Standards and regulations

EC declaration of conformity

(see chapter 11.6 - "EC declaration of conformity")

1.6 Scope of Supply

The centrifuge comprises:

- | | |
|---|------------------|
| • 1 rotor wrench, size 13 | Part no. 930 102 |
| • 1 hexagon socket wrench (size 5) | Part no. 930 051 |
| • 1 tube of grease for load bearing bolts | Part no. 70 284 |
| • 1 bottle of slushing oil | Part no. 70 104 |

Documentation

Operating manual incl. EC declaration of conformity
(see chapter 11.6 - "EC declaration of conformity")

Accessories

according to your order, our order confirmation, and our delivery note.

2 Layout and mode of operation

2.1 Layout of the centrifuge

2.1.1 Functional and operating elements

- 1 Lid
- 2 User interface (see chapter 6.3.1 - "User interface")
- 3 Mains switch



Fig. 1: Total view of the centrifuge

- 4 Name plate (see chapter 2.1.2 - "Name plate")
- 5 Fuse holder
- 6 Equipotential bonding screw
- 7 Mains cable



Fig. 2: Rear view of the centrifuge

2 Layout and mode of operation

2.1.2 Name plate

- 1 Manufacturer and registered office
- 2 Type
- 3 Serial number
- 4 Max. speed
- 5 Max. kinetic energy
- 6 Max. density
- 7 Nominal voltage
- 8 Input fuse
- 9 Symbol for special disposal(see chapter 9 - "Disposal")
- 10 CE mark in compliance with the directive 2006/42/EC
- 11 Part number
- 12 Year of manufacture
- 13 Power consumption



Fig. 3: Example of a name plate

2.2 Mode of operation

2.2.1 Centrifugation principle

Centrifugation is a process for the separation of heterogeneous mixtures of substances (suspensions, emulsions, or gas mixtures) into their components. The mixture of substances, which rotates on a circular path, is subject to centripetal acceleration that is several times greater than the gravitational acceleration.

Centrifuges use the mass inertia inside the rotor chamber for separating the substances. Due to their higher inertia, particles or media with a higher density travel outwards. In doing so, they displace the components with a lower density, which in turn travel towards the centre.

The centripetal acceleration of an object inside a centrifuge, as the effect of centripetal force, depends on the distance between the object and the axis of rotation as well as on the angular velocity. It increases linearly as a function of the distance with regard to the axis of rotation and quadratically as a function of the angular velocity. The bigger the radius in the rotor chamber is and the higher the speed is, the higher the centripetal acceleration is. However, the forces acting on the rotor also increase.

2.2.2 Area of application

Depending on the area of application of the centrifuge and also on the particle size, solids content, and volume throughput of the mixture of substances that is to be centrifuged, there are different types of centrifuges. The areas of application go from household use as a salad spinner or honey separator up to specialised technical applications in the clinical, biological, or biochemical context:

- For numerous clinical examinations, cellular material must be separated from the liquid to be analysed. The normal separation process can be sped up considerably by using laboratory centrifuges.
- In the metal-working industry, centrifuges are used for separating oil from metal cuttings. Dairies use centrifuges in order to separate cow's milk into cream and low-fat milk.
- Particularly big centrifuges are used in the sugar industry for separating the syrup from the crystalline sugar.
- Ultracentrifuges are predominantly used in biology and biochemistry in order to isolate particles, e.g. viruses. They are specifically designed for high speeds up to 500,000 rpm. The rotor moves in a vacuum in order to avoid air friction.

2 Layout and mode of operation

2.2.2.1 Speed, radius, and relative centrifugal force

The acceleration g , which the samples are subject to, can be increased by increasing the radius in the rotor chamber and by increasing the speed. These three parameters are interdependent and linked with each other via the following formula:

$$\text{Relative centrifugal force RCF} = 11.18 \times 10^{-6} \times r \times n^2$$

r = radius in cm

n = speed in rpm

RCF without any dimension

If two values are entered, the third value is determined by way of the stated formula. If, afterwards, the speed or the radius is changed, the resulting relative centrifugal force will be recalculated automatically by the control unit. If the RCF is changed, the speed will be adapted while the specified radius is maintained.

The speed-gravitational-field-diagram provides an overview of the relationship between speed, radius, and RCF (see chapter 11.2 - "Speed-gravitational-field-diagram").

2.2.2.2 Density

The laboratory centrifuge is suitable for the separation of constituents of different densities in mixtures with a maximum density of 1.2 g/cm^3 . All information concerning the speed of rotors and accessories refers to liquids with a density corresponding to this specification. If the density is above this value, the maximum permissible speed of the centrifuge must be reduced based on the following formula:

















$$n = n_{\max} \times \sqrt{(1.2 / \text{Rho})}$$

Rho = density in g/cm^3

3 Safety

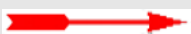
3.1 Marking of the unit

The following symbols are used for all types of centrifuges manufactured by Sigma:

| | | | |
|---|--|---|---|
|  | Dangerous voltage |  | On (Power) |
|  | Hot surface |  | Off (Power) |
|  | Caution! Risk of bruising |  | Name plate (see chapter 2.1.2 - "Name plate") |
|  | Protective earth (ground) |  | CE mark in compliance with the directive 2006/42/EC |
|  | Earth (ground) |  | Do not dispose as part of domestic waste |
|  | Unplug the mains plug |  | GS mark (tested safety; only for Germany) |
|  | Arrow indicating the direction of rotation |  | NRTL mark (only for the USA and Canada) |
|  | 4°C Guarantee |  | RCM mark (only for Australia) |
|  | Centrifuge with heating system | | |

i
NOTE

Safety indications on the centrifuge must be kept readable at all times. If necessary, they must be replaced.

i
NOTE

Not all of the symbols/labels are used for this centrifuge type.

3 Safety

3.2 Explanation of the symbols and notes

In this operating manual, the following names and symbols to indicate hazards are used:



DANGER

This symbol stands for a **direct** hazard to the life and health of persons.

Non-observance of these symbols **causes** serious health problems up to life-endangering injuries.



DANGER

This symbol stands for a **direct** hazard to the life and health of persons due to electrical voltage.

Non-observance of these symbols **causes** serious health problems up to life-endangering injuries.



WARNING

This symbol stands for a **potential** hazard to the life and health of persons.

Non-observance of these symbols **can** cause serious health problems up to life-endangering injuries.



CAUTION

This symbol indicates a potentially hazardous situation

Non-observance of these notes can cause minor injuries or damage to property.



NOTE

This symbol indicates important information.

3.3 Responsibility of the operator

The operator is responsible for authorising only qualified personnel to work on the centrifuge (see chapter 3.4 - "Operating personnel").

The areas of responsibility of the personnel concerning the operation, maintenance, and care of the unit must be clearly defined.

The safety-conscious work of the personnel in compliance with the operating manual and the relevant EC and national health and safety regulations as well as with the accident prevention regulations must be checked at regular intervals (e.g. every month).

Under the international rules for health and safety at work, the operator is obliged to:

- take measures in order to prevent all danger to life or health during work.
- ensure that centrifuges are operated properly and entirely as intended (see chapter 1.2 - "Intended use").
- take protective measures against fire and explosion when working with hazardous substances.
- take measures for the safe opening of centrifuges.

3.4 Operating personnel

Persons operating the unit must

- be familiar with the fundamental regulations concerning workplace safety and accident prevention
- have read and understood this operating manual (and in particular the safety sections and warning notes) and confirmed this with their signature.

3.5 Informal safety instructions

- This operating manual is a part of the product.
- The operating manual must be kept at the location of use of the centrifuge. Ensure that it is accessible at all times.
- The operating manual must be handed over to any subsequent owner or operator of the centrifuge.
- Any changes made must be added to the operating manual.
- In addition to the operating manual, the general and local rules and regulations concerning the prevention of accidents and the protection of the environment must also be supplied.
- Safety and danger indications on the centrifuge must be kept readable at all times. If necessary, they must be replaced.

3 Safety

3.6 Safety instructions

3.6.1 Electrical safety

To reduce the risk of electrical shock, the centrifuge uses a three-wire electrical cord and plug to connect the equipment to earth-ground. To preserve this safety feature:



DANGER

- Ensure that the wall socket is properly wired and grounded.
- Check that the mains voltage agrees with the nominal voltage listed on the name plate.
- Do not place vessels containing liquid on the centrifuge lid or within the safety distance of 30 cm around the centrifuge. Spilled liquids may get into the centrifuge and damage electrical or mechanical components.
- Work on the power supply system must only be performed by certified electricians.
- Inspect the electrical equipment of the unit regularly. Defects such as loose or burnt cables must be eliminated immediately.

3.6.2 Mechanical safety

In order to ensure the safe operation of the centrifuge, observe the following:



WARNING

- Do not open the lid when the rotor is in motion!
- Do not reach into the rotor chamber when the rotor is in motion!
- Do not use the centrifuge if it was installed incorrectly.
- Do not use the centrifuge without panels.
- Do not use the centrifuge if the rotors and inserts show signs of corrosion or other defects.
- Only use the centrifuge with rotors and accessories that have been approved by the manufacturer. In case of doubt, contact the manufacturer (see chapter 7.3 - "Service contact").
- Do not hold your fingers between the lid and the housing when closing the lid. Risk of crushing!
- Defective lid relieving devices could cause the centrifuge lid to fall (contact the service department, if necessary). Risk of crushing!
- Do not hit or move the centrifuge during its operation.
- Do not lean against or rest on the centrifuge during its operation.
- Do not spin any substances that could damage the material of the rotors and buckets of the centrifuge in any way. Highly corrosive substances, for example, damage the material and affect the mechanical strength of the rotors and buckets.
- Stop the centrifuge immediately in the event of a malfunction. Eliminate the malfunction (see chapter 7 - "Malfunctions and error correction") or inform the service department of the manufacturer (see chapter 7.3 - "Service contact").
- Ensure that all repairs are performed only by authorised and specialised personnel.

WARNING

- Prior to any start-up, check the centrifuge, rotor, and accessories for signs of damage that can be discerned from the outside. Special attention must be paid to all of the rubber parts (e.g. motor cover, lid seal, and adapters) in terms of visible structural changes. Defective parts must be replaced immediately.
- Open the centrifuge when it is not in use so that moisture can evaporate.

3.6.3 Fire prevention

DANGER

- Do not spin explosive or inflammable substances.
- Do not use the centrifuge within hazardous locations.

3.6.4 Chemical and biological safety

If pathogenic, toxic, or radioactive samples are intended to be used in the centrifuge, it is in the responsibility of the user to ensure that all necessary safety regulations, guidelines, precautions, and practices are adhered to accordingly.

DANGER

- Infectious, toxic, pathogenic, and radioactive substances may only be used in special, certified containment systems with a bio-seal in order to prevent the material from being released.
- Take suitable precautions for your own safety if there is a risk of toxic, radioactive, or pathogenic contamination
- Materials that chemically react with each other with a high level of energy are prohibited.

WARNING

- Keep informed about local measures to avoid harmful emissions (depending on the substances to be centrifuged).
- Protective clothing is not required for the operation of the centrifuge. The materials to be centrifuged may, however, require special safety measures (e.g. centrifugation of infectious, toxic, radioactive, or pathogenic substances).

3 Safety

3.6.5 Safety instructions for centrifugation

For safe operation, observe the following before starting the centrifuge:



WARNING

- Ensure that the centrifuge was set up properly (see chapter 5 - "Set-up and connection").
- Maintain a safety distance of at least 30 cm (12 inches) around the centrifuge.
- Do not store any dangerous goods in the centrifuge area.
- Do not stay in the safety area longer than what is absolutely necessary for the operation of the centrifuge.
- Only use the centrifuge with rotors and accessories that have been approved by the manufacturer. We explicitly warn against the use of equipment of poor quality. Breaking glass or bursting vessels can cause dangerous imbalances at high speeds
- Ensure that rotor and buckets are correctly fitted (see chapter 6.2.2.1 - "Installation of the rotor").
- Observe the instructions on the installation of accessories (see chapter 6.2.2.3 - "Installation of accessories").
- The rotor must be loaded axial symmetrically at equal weights.
- If liquids with a density $> 1.2 \text{ g/cm}^3$ are used, reduce the speed (see chapter 2.2.2.2 - "Density").
- Do not use the centrifuge if the rotor is loaded asymmetrically.
- Do not use the centrifuge with tubes that are excessively long.



WARNING

3.6.6 Resistance of plastics

Chemical influences have a strong effect on the polymeric chains of plastics, and, therefore, on their physical properties. Plastic parts can be damaged if solvents, acids, or alkaline solutions are used.



NOTE

- Refer to the resistance data (see chapter 11.5 - "Resistance data")!

3.6.7 Service life of rotors and accessories

The rotors and accessories have a limited service life.



WARNING

- Perform regular checks (at least once per month) for safety reasons!
- Pay special attention to changes, such as corrosion, cracks, material abrasion, etc.
- After 10 years, they must be inspected by the manufacturer.
- After 50,000 cycles, the rotor must be scrapped for reasons of safety.
- If other data concerning the service life are engraved on the rotor or bucket, these data shall apply accordingly. For example, a bucket with the engraving “max. cycles = 10,000” has a service life of 10,000 cycles, and a rotor with the engraving “Exp. date 02/20” must be scrapped in February 2020 at the latest (see figure).



Fig. 4: Different service life – engraving on the bucket/rotor



NOTE

- Refer to the table of rotors and accessories with a different service life (see chapter 11.4 - "Table of the service life of rotors and accessories")!

3 Safety

3.7 Safety devices

3.7.1 Lid lock device

The centrifuge can only be started when the lid is properly closed. The electrical lock must be locked. The lid can only be opened when the rotor has stopped. If the lid is opened by way of the emergency release system during operation, the centrifuge will immediately switch off and decelerate brakeless. If the lid is open, the drive is completely separated from the mains power supply, i.e. the centrifuge cannot be started (see chapter 7.1.1 - "Emergency lid release").

3.7.2 Standstill monitoring system

Opening of the centrifuge lid is only possible if the rotor is at a standstill. This standstill is checked by the microprocessor.

3.7.3 System check

An internal system check monitors the data transfer and sensor signals with regard to plausibility. Errors are detected with extreme sensitivity and displayed as error messages in a dialog box (see chapter 7.2 - "Table of error codes").

3.7.4 Earth conductor check

For the earth conductor check, there is an equipotential bonding screw on the rear panel of the centrifuge (see chapter 2.1.1 - "Functional and operating elements"). An earth conductor check can be carried out by authorized and specialized personnel using a suitable measuring instrument. Please contact the service department (see chapter 7.3 - "Service contact").

3.7.5 Imbalance monitoring system

A dialog box may pop up or emit a sound signal in order to indicate that the centrifuge is in the inadmissible imbalance range. If the rotor is loaded unevenly, the drive will be switched off in the acceleration phase or during the run.

3.7.6 Rotor monitoring system

When a rotor number and, if applicable, a bucket number are selected, the computer will automatically check whether the entered speed or the entered gravitational field are permissible for the selected rotor.

3.8 Measures in the event of hazards and accidents



DANGER

- If an emergency arises, switch off the centrifuge immediately!
- If in doubt, call the emergency doctor!

3.9 Remaining hazards

The unit was built state- of- the- art and according to the accepted safety rules. However, danger to life and limb of the operator, or of third parties, or impairments of the unit or other material assets cannot be completely excluded when the unit is being used.

- Use the unit only for the purpose that it was originally intended for (see chapter 1.2 - "Intended use").
- Use the unit only if it is in a perfect running state.
- Immediately eliminate any problems that can affect safety.

4 Storage and transport

4 Storage and transport

4.1 Dimensions and weight

| | Sigma 6-16S |
|-----------------------|-------------|
| Height: | 483 mm |
| Height with open lid: | 990 mm |
| Width: | 581 mm |
| Depth: | 711 mm |
| Weight: | 116 kg |

4.2 Storage conditions

The centrifuge can be stored in its original packaging for up to a year.

- Store the centrifuge only in dry rooms.
- The permissible storage temperature is between -20°C and +60°C.
- If you would like to store it for more than one year, or if you intend to ship it overseas, please contact the manufacturer.

4.3 Notes on transport

- Install the transport safety device (see chapter 4.5 - "Transport safety device")
- Always lift the centrifuge with a lifting device.
- When lifting the centrifuge, always reach under the centrifuge from the side.



CAUTION

The centrifuge weighs approx. 116 kg!

- For transport, use suitable packaging and, if at all possible, the original packaging (see chapter 4.4 - "Packaging").

4.4 Packaging

The centrifuge is packaged in a wooden crate.

- After taking off the lid, remove the side panels.
- Remove the packaging material.
- Lift the centrifuge upwards with a lifting device to lift it safely. When lifting the centrifuge, always reach under the centrifuge from the side.



CAUTION

The centrifuge weighs approx. 116 kg!

- Retain the packaging for any possible future transport of the centrifuge.

4.5 Transport safety device

The transport safety device consists of two plastic screws which are located at the bottom panel.



CAUTION

The transport safety device must be removed prior to start-up because the screws lock the motor bearings!

Removal

- Lift the centrifuge upwards at the front side. Always reach under from the side.
- Put a suitable object, e.g. a wooden block, between the table and centrifuge. The two plastic screws can now be seen at the bottom panel.

1 Locking screws

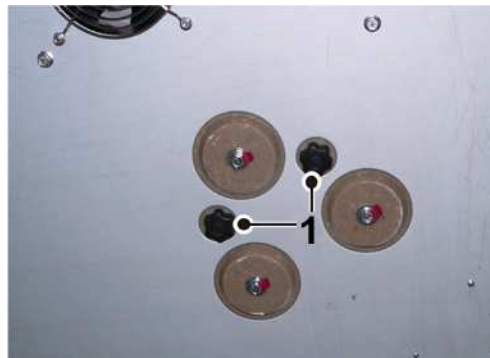

Fig. 5: Locking screws (transport safety device)

- Unscrew the screws by hand anti-clockwise.
- Retain the transport safety device for the possibility of the return of the centrifuge.

5 Set-up and connection

5 Set-up and connection

5.1 Installation site

Operate the centrifuge only in closed and dry rooms.

All the energy supplied to the centrifuge is converted into heat and emitted to the ambient air.

- Ensure sufficient ventilation.
- Keep a safety distance of at least 30 cm around the centrifuge so that the vents in the centrifuge remain fully effective.
- Do not subject the centrifuge to thermal stress, e.g. by positioning it near heat generators.
- Avoid direct sunlight (UV radiation).
- The table must be stable and have a solid, even surface.
- Attention: During transport from cold to warmer places, condensational water will collect inside the centrifuge. It is important to allow sufficient time for drying (min. 24 h) before the centrifuge can be used again.

5.2 Power supply

5.2.1 Type of connection



DANGER

The operating voltage on the name plate must correspond to the local supply voltage!

Sigma centrifuges are units of protection class I. The centrifuges of this model series have a three-wire power cord with a fixed cable. They are equipped with a mains power switch with an integrated thermal circuit breaker.

- Switch the unit off by actuating the mains power switch.
- If it has tripped, let the circuit breaker cool for approximately 2 minutes.
- Switch the unit on.

The centrifuge is now ready for operation.

5.2.2 Customer-provided fuses

Typically, the centrifuge must be protected with 16 Amp L or B fuses that are to be provided by the customer.

6 Using the centrifuge

6.1 Initial start-up



DANGER

- Before the initial start-up, please ensure that your centrifuge is properly set up and installed (see chapter 5 - "Set-up and connection").

6.2 Switching the centrifuge on

- Press the mains power switch.

The display then illuminates. The centrifuge is ready for operation.

6.2.1 Opening and closing the lid

The lid can be opened if the centrifuge is at a standstill and if the lid key is illuminated.

- Press the lid key in order to open the lid.

The centrifuge cannot be started if the lid is opened.

- To close, press with both hands slightly on the lid until the electrical lock is locked.



WARNING

Do not place your fingers between the lid and the housing when closing the lid. Risk of crushing!

6.2.2 Installation of rotors and accessories

6.2.2.1 Installation of the rotor

- Open the centrifuge lid by pressing the lid key.
- Unscrew the rotor tie-down screw from the motor shaft (counter-clockwise).
- Lower the rotor with its central bore straight down onto the motor shaft.
- Tighten the rotor tie-down screw clockwise with the supplied rotor wrench with 10 Nm. In doing so, hold the rotor at its outer rim.



WARNING

Once a day or after 20 cycles, the rotor tie-down screw must be loosened by some turns, and the rotor must be lifted and fastened again. This ensures a proper connection between the rotor and the motor shaft.

6 Using the centrifuge



CAUTION

When using rotors for microtiter plate formats:
Ensure that the plate holders are inserted together with the plates into the buckets.



NOTE

The lid screw serves for the fastening of the lid onto the rotor only, not for the fastening of the rotor onto the motor shaft.

- Follow the safety instructions and hazard warnings (see chapter 3 - "Safety")!

6.2.2.2 Installation of angle rotors with a hermetically sealed lid

- Screw the rotor cover onto the rotor and tighten it.
- Lower the rotor with the cover onto the motor shaft .
- Insert the rotor tie-down screw into the motor shaft. Tighten the rotor tie-down screw with 10 Nm using the supplied rotor wrench so that the spring washer assembly is compressed tightly.
- The rotor can also be used without a cover.
- The rotors can be installed or removed with a closed lid after loosening the rotor tie-down screw.
- Follow the safety instructions and hazard warnings chapter 3 - "Safety"!

- 1 Rotor tie-down screw
- 2 Lid
- 3 Rotor

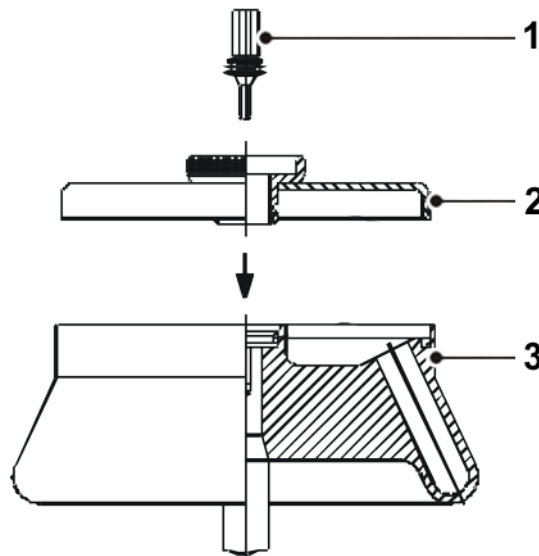

Fig. 6: Angle rotor with a hermetically sealed lid

6.2.2.3 Installation of accessories

- Only use inserts that are suitable for the rotor (see chapter 11.1 - "Range of accessories").
- All buckets of the swing-out rotor need to be installed when spinning.
- Always load the axial symmetrical inserts/buckets of the rotors with the same accessories and fill to avoid imbalance.

Centrifugation with different tube sizes

Working with different tube sizes is possible. In this case, however, it is very important that axial symmetric inserts are identical (see figure).

correct

incorrect

Fig. 7: Permissible and impermissible loading of a swing-out rotor with different tube sizes (example illustrations)

6 Using the centrifuge

Centrifugation with low capacity

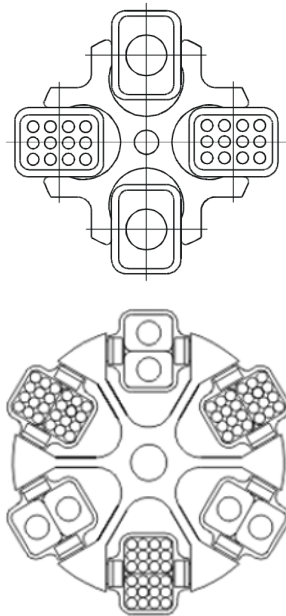
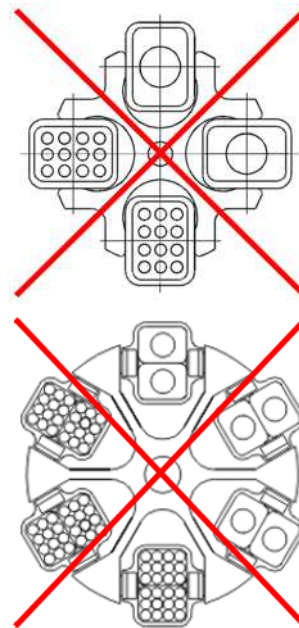
- Install the tubes axial symmetrically so that the buckets and their inserts are loaded evenly.
- It is not permissible to load angle rotors on only one axis.

correct

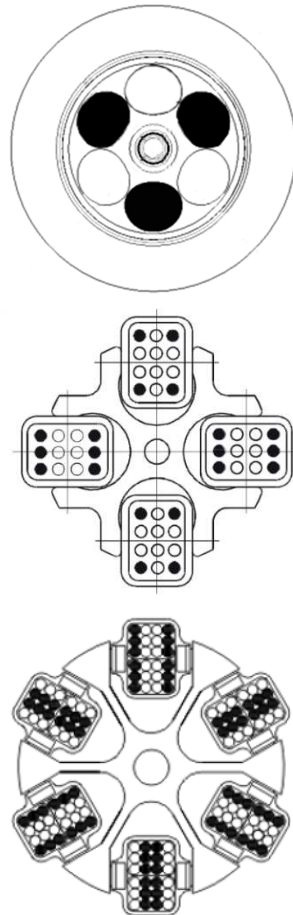

incorrect

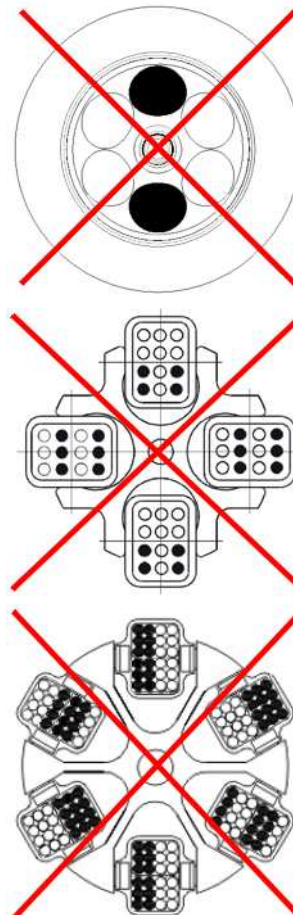

Fig. 8: Permissible and impermissible loading of an angle rotor and a swing-out rotor (example illustrations)

6.2.2.4 Adapters

In order to ensure easy handling, even if vessels of various sizes are used, carrier systems were developed.

- Load the opposite adapters with the same number of vessels and with the same weights in order to avoid imbalance.
- If all of the compartments of a carrier are not used, the buckets must be loaded evenly. Loading the edges of a bucket only is not permissible.

6 Using the centrifuge

6.2.2.5 Tubes

- Load the tubes outside of the centrifuge. Liquids in the buckets or multiple carriers cause corrosion .
- Fill the tubes carefully and arrange them according to their weight. Imbalances result in the excessive wear of the bearings.
- In high-speed angle rotors, the vessels must be filled up to their useful volume (= the volume stated for the vessel). If the vessels are only partially filled, they will deform. This may result in leaks at the seals that may become loose.
- When using glass tubes, the maximum value of 4,000 x g must not be exceeded (except special high-strength glass tubes; please refer to the information provided by the manufacturer).
- Follow the safety instructions and hazard warnings (see chapter 3 - "Safety")!

6.2.2.6 Blood bag systems

The centrifuge tolerates an imbalance of approx. 20 g. Therefore, it is important to balance the buckets carefully.

- All four places of a rotor must be loaded with buckets. It is permissible to fill just two opposite buckets with blood bag systems.
- The opposite buckets including the filled blood bag systems must have an equal weight.
- The blood bags have to be put into the opposite buckets mirror-inverted.
- If in one bucket the main blood bag is on the left side, then the main blood bag inserted in the opposite bucket has to be on the right side.

- 1 Filter
2 Blood bag

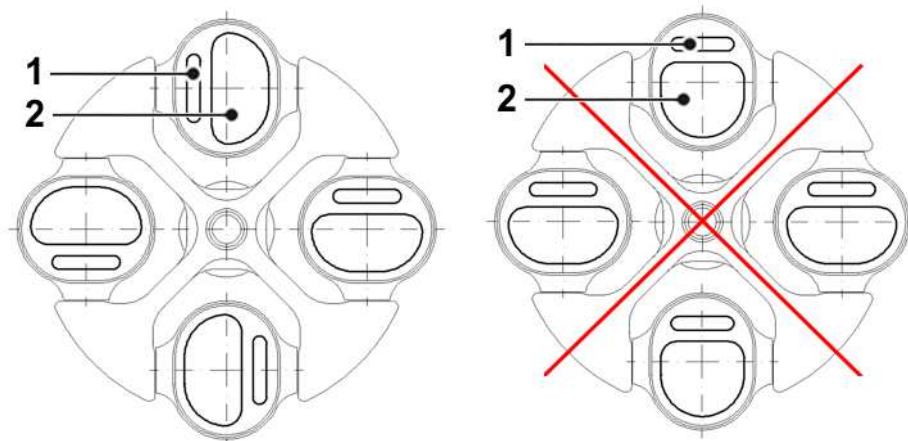

Fig. 9: Loading of blood bag systems

- When using smaller bag systems or in case of incompletely filled blood bags adapters (e.g. part no. 17750) have to be inserted together with the blood bag systems. This will avoid slipping of the bags which could result in an imbalance.
- For the centrifugation of human blood suitable acceleration and deceleration curves must be used. Curve no. 12 is the most suitable for this purpose.

A German blood bank works successfully using the following data:

6 Using the centrifuge

| Temperature ¹⁾ | Speed | RCF | Timet | Acceleration curve ²⁾ | Deceleration curve | Program |
|---------------------------|-------|-------|-------|----------------------------------|--------------------|-----------------------------|
| °C | rpm | x g | min | no. | no. | |
| 22 | 3,750 | 4,544 | 7 | 20 (2 min) | 12 | 1 Full blood |
| 22 | 3,570 | 4,544 | 10 | 20 (2 min) | 12 | 2 Full blood in 4fold bags |
| 20 | 4,000 | 5,170 | 12 | 24 (3 min) | 12 | 3 Plasma with buffy coat |
| 22 | 3,750 | 4,544 | 9 | 20 (2 min) | 12 | 4 Full blood |
| 20 | 4,000 | 5,170 | 14 | 24 (3 min) | 12 | 5 Plasma with buffy coat |
| 22 | 1,094 | 384 | 7 | 21 (2 min) | 11 or 2 min | 6 Platelets with buffy coat |
| 22 | 1,094 | 384 | 7 | 21 (2 min) | 11 or 3.5min | 7 Platelets with buffy coat |

¹⁾ only with special equipment heater

²⁾ Curves no. 20, 21 and 24 are freely programmable curves



NOTE

If the centrifuge does not reach the mentioned RCF values, the maximum gravitational field must be set and the run time must be extended.

6.2.2.7 Centrifugation with tubes for mineral oil

In the previous ASTM standard, a maximum gravitational field of 800 x g is required for the centrifugation with tubes for mineral oil. Practically, it is possible to reach higher RCF-values with the rotor 11165 and the buckets 13113, 13114 or 13116..



CAUTION

The required gravitational field must not be exceeded. Values above 800 x g increase the risk of glass breakage!

- Use sealing caps (part no. 17107).

6.3 Control system "Spincontrol S"

6.3.1 User interface

The centrifuge is operated via three buttons with integrated light-emitting diodes and one function knob. The display is divided into several different fields. The various functions of the system can be called up by pressing and turning the function knob.

- 1 Start key
- 2 Display
- 3 Function knob
- 4 Stop key
- 5 Lid key

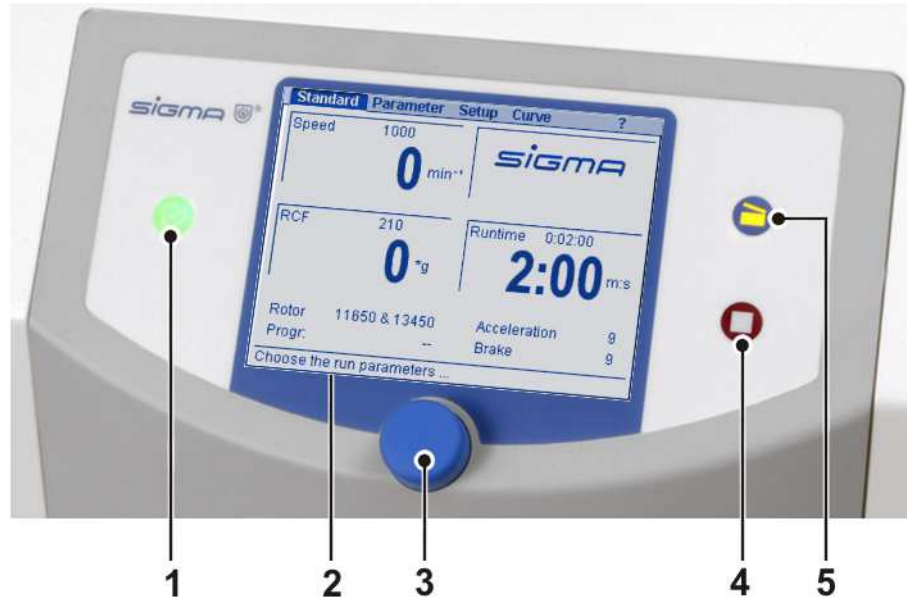

Fig. 10: User interface of the Spincontrol S control system

Display

The centrifuge display has the following fields:

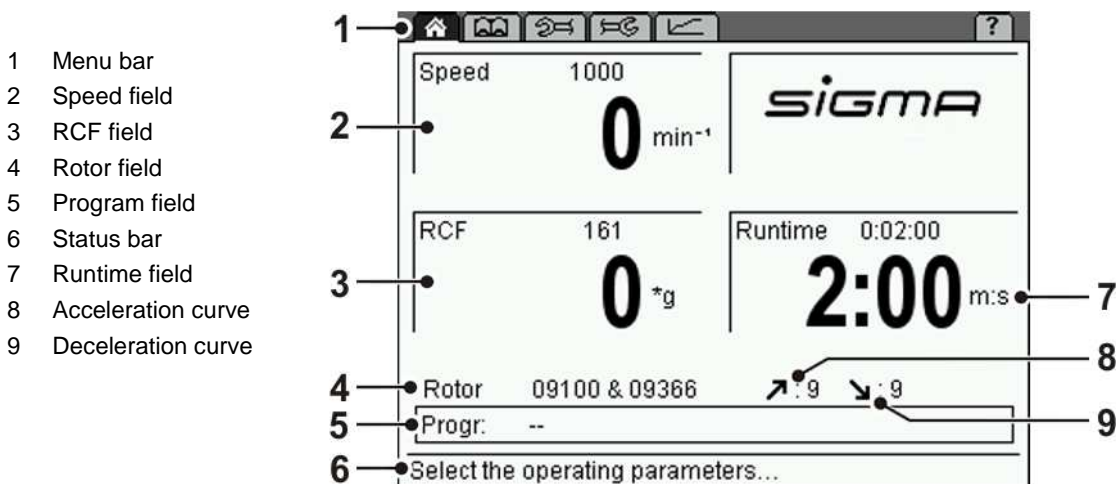

Fig. 11: Display of the Spincontrol S control system

6 Using the centrifuge

6.3.2 Manual mode

6.3.2.1 Starting a centrifugation run

The centrifuge is ready for operation when the start key is illuminated.

- Press the start key in order to start a centrifugation run.

6.3.2.2 Interrupting a centrifugation run

- Press the stop key in order to interrupt a centrifugation run. The centrifugation run will be terminated prematurely.

Quick stop

- Press the stop key for more than three seconds.

The centrifuge decelerates with the maximum deceleration curve.

After a quick stop, the centrifuge lid must be opened before a new centrifugation run can be started.

A quick stop can also be triggered during a normal deceleration, e.g. in order to speed up the deceleration.

When a quick stop is triggered, "Quick stop" will be displayed in the speed field.



NOTE

A quick stop can be performed even if the centrifuge is blocked against unauthorised use.

6.3.2.3 Interrupting a deceleration process

- Press the start key during a deceleration process in order to interrupt it and to restart the centrifuge.

6.3.2.4 Selection, display, and modification of data

The "Standard" menu is displayed.

- Turn the function knob in order to select a field. The selected field is inverted.
- Press the function knob. The display starts to flash and the modification mode is active.
- Turn the function knob in order to modify the set value of the selected field.
- Press the function knob again to confirm the entry and to quit the modification mode.

6.3.2.5 Standard menu

The "Standard" menu is symbolised by the icon "⌘" on the menu bar and it is displayed a few seconds after the centrifuge has been switched on. In this menu, the parameters of a centrifugation run can be displayed and modified.

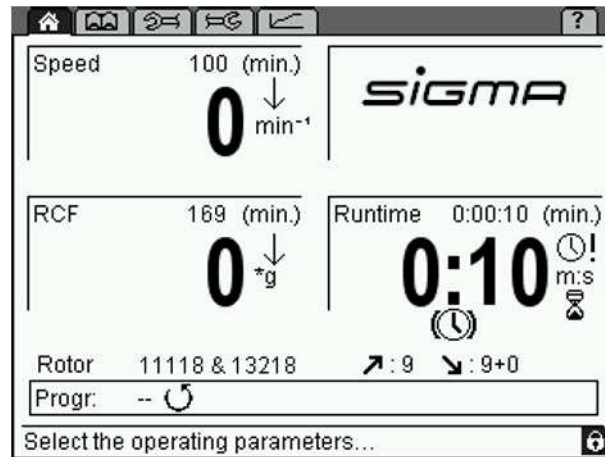

Fig. 12: Standard menu; here shown with all of the possible symbols

Speed

In the upper section of the field, the set speed of the centrifuge is displayed. The actual speed is displayed below this value. The values are stated in revolutions per minute ($\text{min}^{-1} = \text{rpm}$) and depend on the RCF values (see chapter 2.2.2.1 - "Speed, radius, and relative centrifugal force"). The maximum speed values depend on the rotor that is used.

Relative centrifugal force (RCF)

The relative centrifugal force is the acceleration that the sample is subjected to during the centrifugation run. The set value of this parameter is displayed in the upper section of this field, with the actual value shown below. The values are stated in g (gravitational acceleration) and they depend on the speed values (see chapter 2.2.2.1 - "Speed, radius, and relative centrifugal force"). The maximum RCF values depend on the rotor that is used.

Runtime

The set runtime is displayed in the upper section of this field, with the remaining runtime shown below. The runtime is defined as the period from the start of the centrifuge to the beginning of the deceleration phase. The maximum value is 99 h 59 min 59 sec.

In the "Setup" menu , it can be specified that the runtime is not to be started until the set speed is reached (see chapter 6.3.2.8 - "Setup menu"). In this case, the symbol "⌚!" appears in the runtime field.

6 Using the centrifuge

Continuous run

During the continuous run, the runtime of the centrifuge is unlimited and must be stopped manually. The centrifuge accelerates during the continuous run until the set speed is reached.

- Select the field "Runtime" and press the function knob. The display flashes when it is activated.
- Turn the function knob from the time 0:00:10 anti-clockwise or from the time 99:59:59 clockwise. "Infinite" will be displayed. After the start of the centrifuge, the elapsed time will be displayed.
- Deactivate the continuous run by pressing the stop button or by entering a specific runtime.

Short run

A short run can be started if no run is active.

- Keep the start button pressed during the short run.

During the short run, the centrifuge accelerates with acceleration curve 9 (maximum acceleration) until the maximum speed of the rotor is reached. The runtime is counted and in the speed field the message "Short run" flashes.

When the start button is released, the centrifuge decelerates with the maximum deceleration curve to a standstill.



NOTE

The parameters speed, RCF, and runtime can be changed during the centrifugation.



NOTE

If the centrifuge is locked with level 02 or higher, it is not possible to start a short run.

Rotor: rotor selection list

This field shows the rotor that is currently being used.

- Select the field "Rotor" and confirm the selection. A list with all of the possible rotors without buckets is displayed.
- Select the desired rotor.
 - If an angle rotor is selected, additional information concerning this rotor will be displayed.
 - In the case of swing-out rotors, a list with all of the possible rotor/bucket combinations will be displayed. Select an item from the list so that the additional information concerning the combination will be displayed.
- Press the function knob in order to accept the data.

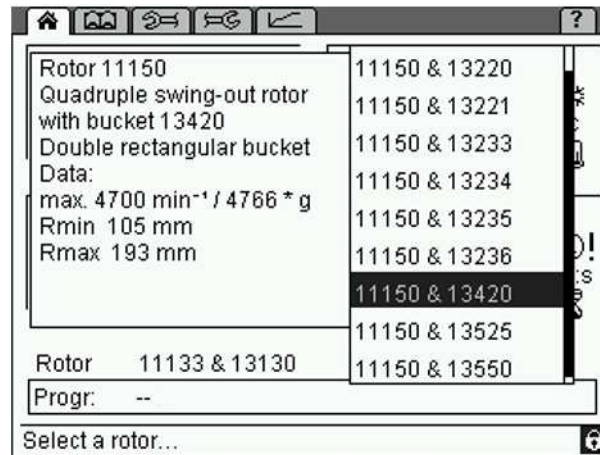

Fig. 13: Rotor selection list; here for a swing-out rotor

Automatic rotor identification

The centrifuge automatically identifies the rotor that is being currently used.

- If the system identifies a different rotor than the one that is set and if there are no different buckets for this rotor, the rotor input will be adapted automatically. The system will not display a message.
- If the system identifies a different rotor than the one that is set, and if there are different rotor/bucket combinations for this rotor, the system will automatically identify the correct rotor and select the rotor/bucket combination with the lowest speed. The system will display a corresponding message so that the combination can be adapted manually.
- If the system cannot identify the rotor, a message will be displayed. The rotor cannot be used in the centrifuge.

This prevents the maximum permissible speed from being exceeded.

Acceleration ↗

This function is used to select an acceleration curve. One can select a linear rise (curves 0-9) or a quadratic rise (curves 10-19). The acceleration curves 20-29 can be programmed as desired (see chapter 11.3 - "Acceleration and deceleration curves").

Deceleration (brake) ↘

This function is used to select a curve that decelerates the centrifuge to a standstill. Deceleration curves are inverted images of the acceleration curves and are labelled with identical numbers. Deceleration curve no. 0 represents a brakeless deceleration.

6 Using the centrifuge

Progr.: program list

This field in the "Standard" menu shows the program that is currently loaded. When the field is selected, the program list is displayed (for information on how to work with the programs, please see chapter 6.3.3 - "Program mode").

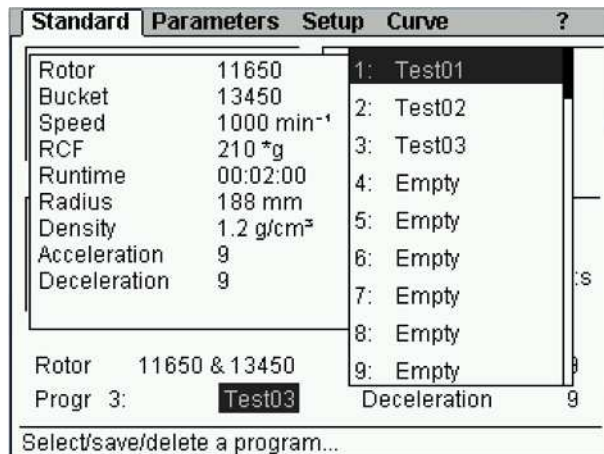

Fig. 14: Program list

Progress indicator

The progress indicator provides a quick overview of the remaining runtime of the running centrifugation run. For this purpose, a green progress bar and percentage value are displayed in the program field.



Fig. 15: Progress indicator during a centrifugation run

After the completion of the centrifugation run, the progress indicator remains at 100% until

- the lid is opened,
- a parameter is changed,
- a program is loaded, saved, or deleted, or
- a new centrifugation run is started.

6.3.2.6 Process library menu

The process library can be opened via the "📖" symbol on the menu bar. It provides the user with an overview of all of the stored programs as processes.

The processes are listed with their name, RCF, and runtime.

The order of the processes corresponds to their storage locations on the program list. Empty storage locations will not be displayed. If more than 11 programs have been stored, the user can scroll through the list.

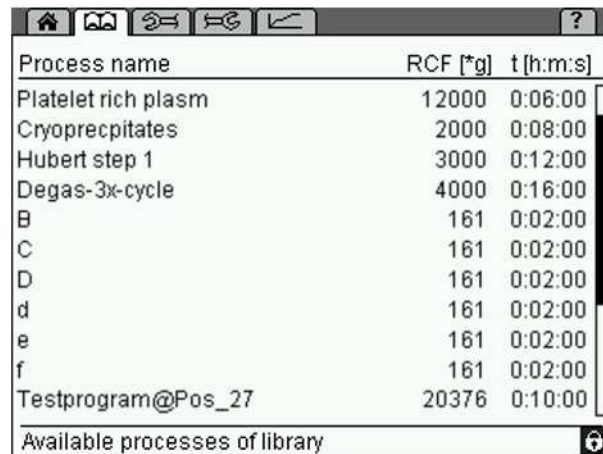

| Process name | RCF [*g] | t [h:m:s] |
|---------------------|----------|-----------|
| Platelet rich plasm | 12000 | 0:06:00 |
| Cryoprecipitates | 2000 | 0:08:00 |
| Hubert step 1 | 3000 | 0:12:00 |
| Degas-3x-cycle | 4000 | 0:16:00 |
| B | 161 | 0:02:00 |
| C | 161 | 0:02:00 |
| D | 161 | 0:02:00 |
| d | 161 | 0:02:00 |
| e | 161 | 0:02:00 |
| f | 161 | 0:02:00 |
| Testprogram@Pos_27 | 20376 | 0:10:00 |

Available processes of library

Fig. 16: Process library menu

Loading a process

- In the process library, select the desired process by turning the function knob. Press the function knob in order to confirm the selection.

The process will be loaded and the "Standard" menu 🏠 will be displayed.

Starting a process

- In the process library, select the desired process by turning the function knob. Then, press the start button.

The process will be loaded and started. The "Standard" menu 🏠 will be displayed.

6 Using the centrifuge

6.3.2.7 Parameters menu

The "Parameters" menu is symbolised by the "≡" symbol on the menu bar. It is used to specify various conditions for the centrifugation. These conditions are used to monitor the process and to control access to the centrifuge.

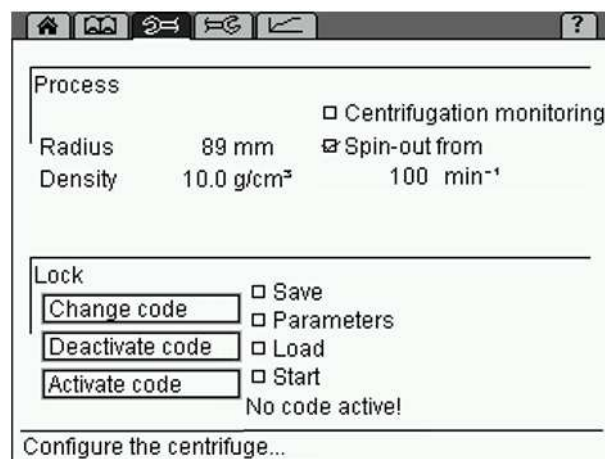

Fig. 17: Menu "Parameters"

Process

Radius

The radius determines the values of the relative centrifugal force (RCF) that the sample is subjected to. Normally, the maximum RCF value is displayed. If the value is reduced manually, a downward facing arrow "↓" will be displayed in the RCF field.

Density

This setting is useful for glass vessels. If the density of the liquid to be centrifuged is higher than 1.2 g/cm³, the value must be adapted manually in order to prevent the glass vessel from breaking. This will reduce the maximum possible final speed (see chapter 2.2.2.2 - "Density"). The reduction will be represented by a downward facing arrow "↓" in the speed field. Values between 1.2 and 10.0 g/cm³ are possible.

Centrifugation monitoring

The centrifugation monitoring function enables the continuous monitoring of the speed and runtime parameters during the centrifugation.

- Activate the centrifugation monitoring function by clicking.



NOTE

If the function is activated during a centrifugation run, the monitoring process will not be started until the start of the next centrifugation run.

The centrifugation monitoring function compares the speed values of the current run with the reference values that are stored in the control unit. After every run, it issues a corresponding message.

6 Using the centrifuge

The runtime is considered faulty if the centrifugation run had to be stopped prematurely.

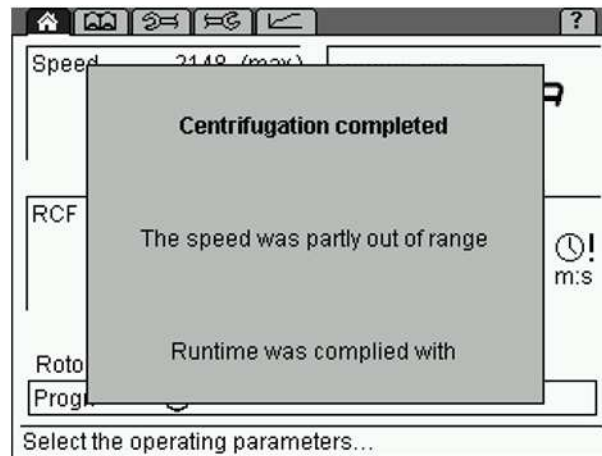

Fig. 18: Example of a centrifugation monitoring message



If the centrifugation monitoring system is used in combination with free acceleration or deceleration curves, unjustified error messages may result in certain cases.

Spin-out from...

If this function is active, the drive will be disconnected if the actual speed is below the set speed. As a result, the rotor decelerates and stops in a brakeless manner.



A spin-out, in particular with heavy rotors and at high speeds, can take a lot of time! (Depending on the rotor and load, the speed will be reduced by approximately 0.5 to 1 rpm per second.)

If the spin-out is active, "+0" is displayed next to the deceleration curve.

- The spin-out can be interrupted by a quick stop or by restarting the centrifuge.

6 Using the centrifuge

Lock

In order to prevent any unauthorised use of the centrifuge, the following functions can be blocked:

- Saving of programs (level 01)
- Changing of parameters, short run (level 02)
- Loading of programs (level 03)
- Start button (level 04)

Blocking a function

- Select the function that is to be blocked. The lower levels will also be automatically selected (if, for example, the "Parameters" function is selected, the "Save" function will also be selected).
- Select the button "Activate code".
- Enter a four-digit code and confirm the entry.

The lock is now active. The symbol "🔒" will be displayed in the status line and the lock level will be indicated.

If changes are made after a function has been blocked, the system will ask for the code prior to executing the change.

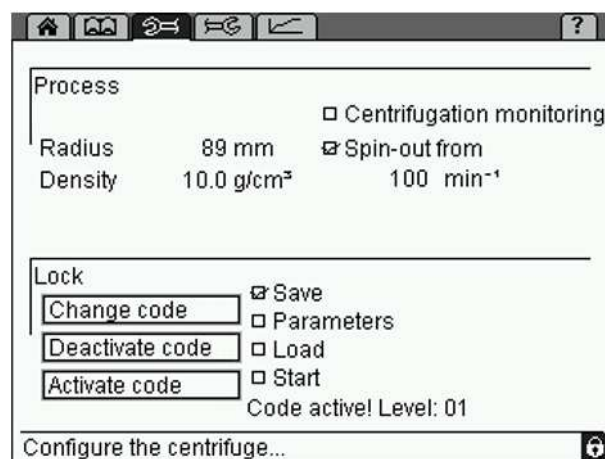

Fig. 19: "Parameters" menu with an active lock (level 01)

Unblocking a function

- Select the button "Deactivate code".
- Enter the code and confirm the entry.

The lock is now deactivated.

Changing the code

- Select the button "Change code".
- Enter the old code and confirm the entry.
- Enter the new code.
- For safety reasons, the code must be entered a second time.

The code is now changed.

6.3.2.8 Setup menu

The "Setup" menu is symbolised by the "⚙️" symbol on the menu bar. It is used to perform basic settings concerning the control system of the centrifuge. It enables the optimum adaptation of the centrifuge to its specific area of application.

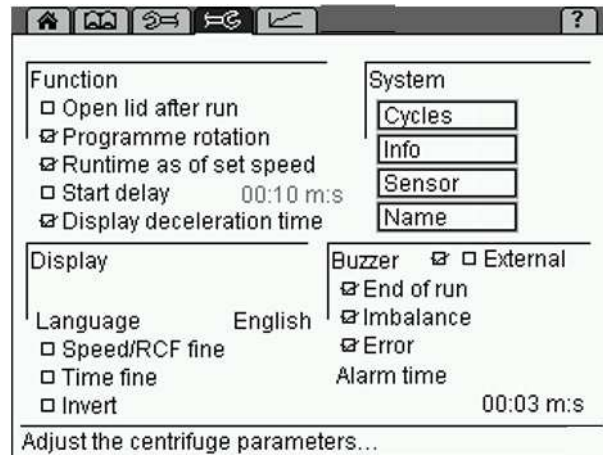

Fig. 20: Menu "Setup"

Function
Open lid after run

The automatic lid opening function ensures that the lid opens when the rotor has stopped.

Program rotation

See chapter 6.3.3.5 - "Automatic program rotation"

Runtime as of set speed

If this function is active, the runtime will not be measured until the set speed is reached. In the "Standard" menu, the symbol "⌚!" will be displayed in the runtime field.



In the program mode, this function can be saved separately for every program. In this case, the symbol "⌚!" will be displayed under the runtime of the detailed program description.

Start delay

If the start delay function is active, the centrifuge will not start until the preset time has elapsed. The symbol "⌚" will be displayed in the runtime field.

Display deceleration time

In the activated mode, the deceleration time will be displayed instead of the runtime during and after the deceleration process. Below the time display, the symbol "⌚" will be displayed. During a deceleration process, the symbol flashes. Once the deceleration is complete, it is displayed in a permanent manner.

6 Using the centrifuge

Display

Language

The control system can be used in various language versions.

If a language is selected by mistake, it can be changed on any screen as follows:

- Press and hold the stop button.
- Turn the function knob one notch to the left and then one notch to the right.
- Release the stop button. The "Language" window will be displayed.
- Select the desired language.

Speed/RCF fine and Time fine

This menu item can be used to preselect the set speed in steps of 1 rpm (instead of 100 rpm), the RCF value in steps of 1 x g (instead of 10 x g), and the set time in steps of 1 min or 1 sec (instead of 10 min or 10 sec).



NOTE

Regardless of the fine adjustment, the step size increases when the function knob is turned quickly.

Invert

If this function is activated, the display switches from the standard setting with a bright background and dark writing to a dark background with bright writing.

System

Cycles

This field shows the number of cycles as well as the runtime of the rotor and buckets that are used.

Info

This menu provides information on the software versions that are used in this centrifuge.

Sensor

The sensor mode is reserved for service personnel.



NOTE

Values can neither be entered nor changed in the menus "Cycles", "Info", and "Sensor".

6 Using the centrifuge

Name

In this field, an identification will be assigned to the centrifuge.

- The letters and characters can be entered when the cursor flashes in the text field. Turn the function knob in order to select a character and press it to confirm the selection. Then, press the knob again in order to enter the next character. Pressing the arrow button ← will delete the last character. The maximum number of characters is 19.
- When the name is complete, select the option "Accept" and confirm it.

Buzzer (signal)

With this function, a warning sound signal can be selected for

- the end of a centrifugation run,
- an imbalance message,
- an error message.

The duration of the warning signal can be specified.

External

This function is only available if the centrifuge is equipped with the option for the input and output of data (external signal, floating switch) (see chapter 6.3.4 - "Options for data input and output").

6 Using the centrifuge

6.3.2.9 Curve menu

This menu is used to create and edit customised acceleration and deceleration curves (see chapter 11.3 - "Acceleration and deceleration curves"). It is symbolised by the "⏮" symbol on the menu bar.

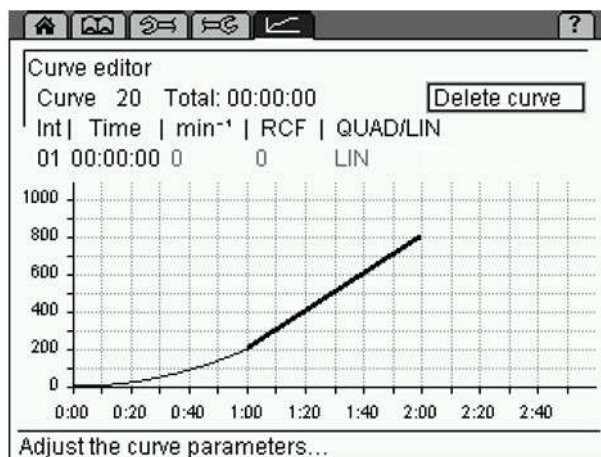

Fig. 21: Menu "Curve"

Creating or changing an acceleration curve



NOTE

During a centrifugation run, curves can only be displayed. They cannot be changed or deleted.

- Select the "Curve" menu. The curve editor will be displayed.
- Select a curve number between 20 and 29 in the input field "Curve". If the curve number is already used, the stored curve will be displayed.
- The input field "Int" is used to specify the interval number of the process. Up to ten intervals can be entered for a curve.
- Enter the interval time of the current interval into the input field "Time". While doing so, certain restrictions must be taken into consideration (see below).
- Enter the desired acceleration under "min⁻¹" (rpm) or "RCF". While doing so, certain restrictions must be taken into consideration (see below). The values are interdependent.
- In the first interval, "QUAD/LIN" can be used to select a linear or quadratic rise. All of the other intervals are linear.

The field "Total" shows the total runtime of the process. The maximum total runtime of a curve depends on the slope of the curve and on the final speed of the rotor.



NOTE

Only the last curve interval can be changed retroactively.

6 Using the centrifuge

Restrictions

- Acceleration and deceleration curves can include intervals with a positive slope as well as intervals with a negative slope and also intervals with 0 slope.
- The slope of the curve intervals can be $1 \text{ min}^{-1}/\text{sec}$ (rpm/sec) minimum and $1000 \text{ min}^{-1}/\text{sec}$ (rpm/sec) maximum.
- Quadratic curve intervals are only possible between 0 and 1000 min^{-1} (rpm) maximum. If a final speed $> 1000 \text{ min}^{-1}$ (rpm) is selected, this interval will automatically become linear above 1000 min^{-1} (rpm).
- The possible runtime results from the maximum possible speed (depending on the rotor) and from the slope limitation.

Example 1: Start speed 0 min^{-1} (rpm), final speed 100 min^{-1} (rpm), runtime 1 hour not possible, since the necessary slope $< 0.03 \text{ min}^{-1}$ (rpm), which means that it is beyond the defined range.

Example 2: Start speed 0 min^{-1} (rpm), final speed 15000 min^{-1} (rpm), runtime 10 sec. not possible, since the necessary slope is 1500 min^{-1} (rpm), which means that it is beyond the defined range.

6.3.2.10 Help menu

The help function is symbolised by the "?" symbol on the menu bar. It provides a short description of the control elements of the selected option.

Activating and deactivating the help function

- Select the question mark on the menu bar and press the function knob.
- Quit the help function by selecting the question mark and by pressing the function knob again.

Parameters can still be changed when the help function is activated.



Fig. 22: Menu "Help"

6 Using the centrifuge

6.3.2.11 Changing the contrast

To change the contrast:

- Press and hold the stop button and turn the function knob one notch to the left. A dialog box will be displayed once the stop button is released.
- Adjust the contrast of the centrifuge display and confirm the change.

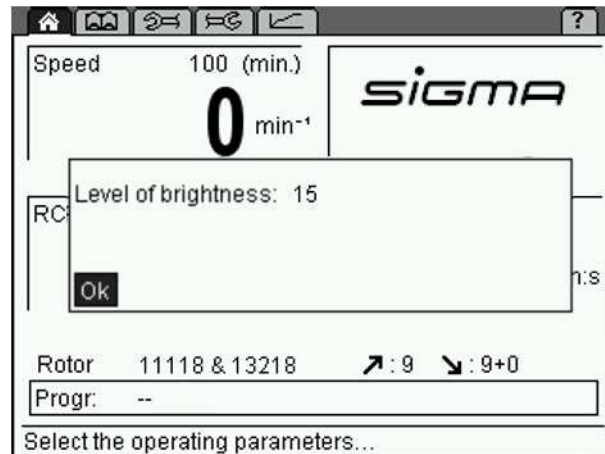

Fig. 23: Dialog box for changing the contrast

6.3.3 Program mode

A program contains all of the data that are required for a centrifuge run. Certain sedimentation results can be repeated under identical conditions. Programs can be loaded, executed, edited, and deleted when the centrifuge is at a standstill.



A maximum of 60 programs can be stored under the numbers 1 - 60.

"--" means that the values that are currently set are not a stored program.

The programs can be protected against unauthorised use, modification, or deletion with the aid of a code (see chapter 6.3.2.7 - "Parameters menu").

Stored programs are listed in the "Process library" menu .

6.3.3.1 Saving a program

- Enter the parameters that are to be included in the program.
- Select the option "Progr" in the "Standard" menu  and confirm the selection. The program list will be displayed.
- Select a storage location from the program list.
- Save the program under the desired name. The letters and characters can be entered when the cursor flashes in the text field.
 - Turn the function knob in order to select a letter and press it to confirm the selection. Then, the next character can be selected.
 - Pressing the arrow button  will delete the last character.
- When the program name is complete, select "OK" and confirm it.

The program will be saved and the "Standard" menu will be displayed.

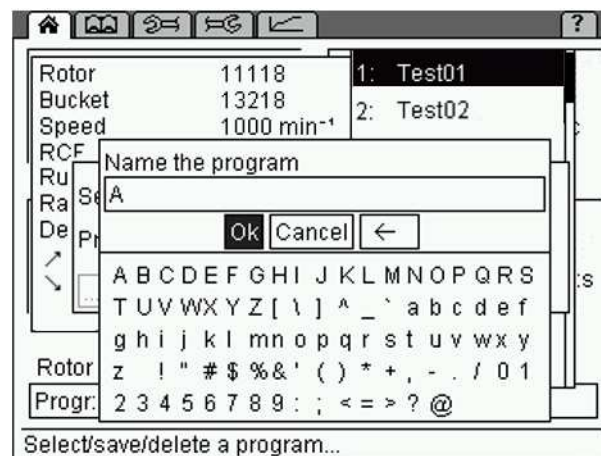



Fig. 24: Assignment of a program name prior to saving the program

6.3.3.2 Loading a program

- Select the option "Progr" from the "Standard" menu  and confirm the selection by pressing the function knob. The program list will be displayed.
- Select the desired program from the list and confirm the selection by pressing the function knob.

Or:

- Open the process library , select the desired program, and confirm the selection by pressing the function knob.

The program will be loaded and the "Standard" menu will be displayed.

6 Using the centrifuge

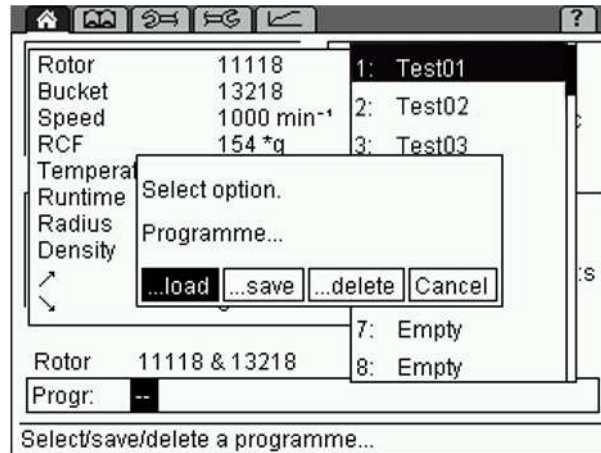



Fig. 25: Loading a program

6.3.3.3 Executing a program

- Select the option "Progr" from the "Standard" menu  and confirm the selection by pressing the function knob. The program list will be displayed.
- Select the desired program from the list and confirm the selection by pressing the function knob.
- Press the start button.

Or:

- Open the process library , select the desired program, and press the start button.

The program will be executed and the "Standard" menu will be displayed.

6.3.3.4 Deleting a program

- Select the option "Progr" in the "Standard" menu  and confirm the selection. The program list will be displayed.
- Select the program that is to be deleted.
- Select the option "Delete" and confirm it.

The program will be deleted and the "Standard" menu will be displayed.

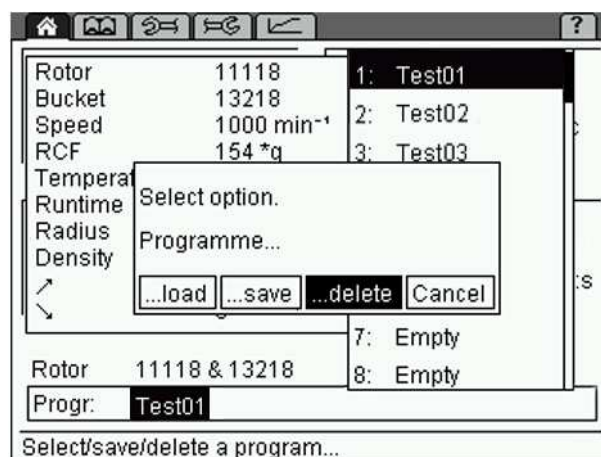



Fig. 26: Deleting a program

6.3.3.5 Automatic program rotation

With the automatic program rotation, several programs can be executed directly one after the other.

- Activate the "Program rotation" function in the "Setup" menu .

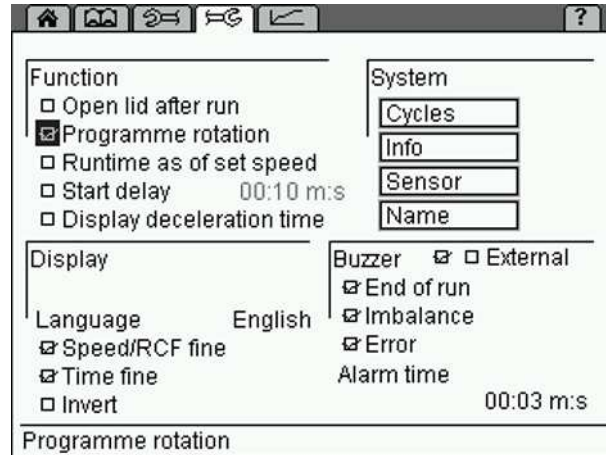

Fig. 27: Program rotation function

When a program is loaded while the program rotation function is active, this program will be used as the start program for the rotation. After the completion of the program, the next program on the program list will be loaded automatically. The rotation continues up to the next empty storage location and then restarts from the beginning (see the following illustration).

Example 1: Loading of Test04

Rotation: Test04, Test05, Test06, Test04,...

Example 2: Loading of Test05

Rotation: Test05, Test06, Test05,...

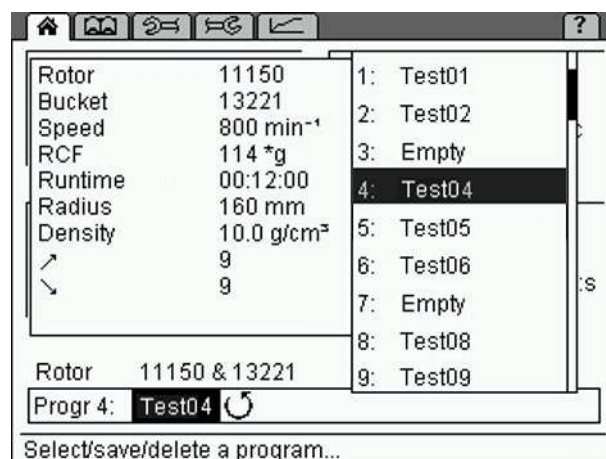

Fig. 28: Automatic program rotation

While the program rotation function is active, the arrow "↻" is displayed in the program line in the "Standard" menu.

6 Using the centrifuge

6.3.4 Options for data input and output

- Connection for a serial interface (depending on the centrifuge type, partly standard).
- External signal active DC 24V, 0.5 A max. (part no. 17701)
- Floating switch AC 250V max., 6 A (part no. 17702)

6.4 Switching the centrifuge off

- Open the centrifuge when it is not in use so moisture can evaporate.
- Switch the centrifuge off by pressing the mains power switch.

7 Malfunctions and error correction

7.1 General malfunctions

Malfunctions are indicated by a dialog box. If the acoustic signal is activated, it sounds when the error message is displayed.

- Eliminate the source of the problem (see table below).
- Acknowledge the error messages by pressing the lid key.

NOTE

Error messages can be eliminated by pressing the lid key. The error itself will not be eliminated, but the centrifuge can be operated again.

| Type of error | Possible reason | Correction |
|--|--|--|
| No indication on the display | No power in the mains supply | Check fuse in the mains supply |
| | Power cord is not plugged in | Plug in power cord correctly |
| | Fuses have tripped | Reactivate temperature fuse (see chapter 5.2.1 - "Type of connection") |
| | Mains power switch off | Switch mains power switch on |
| Centrifuge cannot be started: start key LED is not illuminated | Several | Power off/on. If the error occurs again, contact service |
| Centrifuge cannot be started: lid key LED flashes | The lid lock is not closed correctly | Open and close the lid. If the error occurs again, contact service |
| Centrifuge decelerates during operation | Brief mains power failure | Press start key in order to restart the centrifuge |
| | System error | Power off/on. If the error occurs again, contact service |
| Centrifuge decelerates during operation, imbalance dialog box is displayed | <ul style="list-style-type: none"> – Improper loading – Centrifuge is inclined – Drive problem – Centrifuge was moved during run | Balance load and restart the centrifuge. If the error occurs again, contact service(see chapter 7.1.1 - "Emergency lid release") |
| | – Ungreased load- bearing bolts | Clean and grease load- bearing bolts |
| Lid cannot be opened | Lid lock has not released | Unlock the lid manually (see chapter 4.5 - "Transport safety device") and contact service |
| | Lid seal sticks | Clean the lid seal and apply talcum powder |
| Temperature value cannot be reached (only for refrigerated centrifuges) | Condenser dirty (only air-cooled units) | Clean the condenser. If the error occurs again, contact service |
| Hard running noise during the centrifugation | Screws of the transport safety device are not removed | Remove screws of the transport safety device |

7 Malfunctions and error correction

7.1.1 Emergency lid release

In the event of a power failure, it is possible to manually open the centrifuge lid.

- Switch off the mains power switch and disconnect the power cord from the socket.
- Remove the plugs (see figure, item 1) from the opening on the left and on the right side of the control panel, e.g. with a screwdriver.



Fig. 29: Position of the openings for the emergency lid release

- Insert the supplied hexagon socket key horizontally into the hole. The key will be guided through a funnel-shaped tube to the shaft of the lid lock motor.

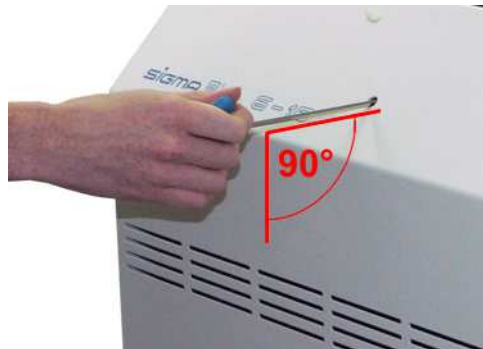

Fig. 30: The emergency lid release key must be inserted horizontally

- Unlock the motorised lid locks as follows:
 - Turn the left lid lock anti-clockwise.
 - Turn the right lid lock clockwise.
- Then, reinsert the plugs.



WARNING

Do not unlock or open the lid unless the rotor is at a standstill.

If the lid is opened via the emergency lid release system during a centrifuge run, the centrifuge will be switched off immediately and decelerate in an unbraked manner.

7 Malfunctions and error correction

7.2 Table of error codes

| Error no. | Kind of error | Measures | Note |
|-----------|---|--|---|
| 1-9 | System error | <ul style="list-style-type: none"> Allow to slow down Power off/on | All these errors stop the centrifuge or cause it to decelerate brakeless |
| 10-19 | Speedometer error | <ul style="list-style-type: none"> Allow to slow down Power off/on | |
| 20-29 | Motor error | <ul style="list-style-type: none"> Power off Ensure ventilation | |
| 30-39 | EEPROM error | <ul style="list-style-type: none"> Allow to slow down Power off/on | With error 34, 35, and 36, the centrifuge will stop; with error 37 and 38 only an error message will be given |
| 40-45 | Temperature error (only for refrigerated centrifuges) | <ul style="list-style-type: none"> Allow to slow down Power off Allow to cool down Provide better ventilation (only air cooled centrifuges) Provide sufficient water throughput (only water cooled centrifuges) | |
| 46-49 | Imbalance error | <ul style="list-style-type: none"> Allow to slow down Power off Eliminate the imbalance | |
| 50-59 | Lid error | <ul style="list-style-type: none"> Press lid key Close lid Remove foreign matter from the opening of the lid lock device | With error 50 and 51, the centrifuge will stop |
| 60-69 | Process error | <ul style="list-style-type: none"> Allow to slow down Power off/on | With error 60 message "power failure during run", with error 61, the message "stop after power on" |
| 70-79 | Communication error | <ul style="list-style-type: none"> Allow to slow down Power off/on | |
| 80-89 | Parameter error | <ul style="list-style-type: none"> Power off Allow to cool down Provide for better ventilation | With error 83, error message only |
| 90-99 | Other errors | <ul style="list-style-type: none"> Check connections Provide sufficient water throughput (only water cooled centrifuges) | |



NOTE

If it is impossible to eliminate the errors, contact the service!

7 Malfunctions and error correction

7.3 Service contact

In the event of queries, malfunctions, or spare part enquiries:

From Germany:

Contact

Sigma Laborzentrifugen GmbH
An der Unteren Söse 50
37520 Osterode (Germany)
Tel. +49 (0) 55 22 / 50 07-44 44
E-mail: support.lab@sigma-zentrifugen.de

Outside Germany:

Contact our agency in your country. All agencies are listed at
www.sigma-zentrifugen.de → [Sales Partners]



NOTE

- If you would like to utilise our service, please state the type of your centrifuge and its serial number.

8 Maintenance and service

The centrifuge, rotor, and accessories are subject to high mechanical stress. Thorough maintenance performed by the user extends the service life and prevents premature failure.



CAUTION

If corrosion or other damage occurs due to improper care, the manufacturer cannot be held liable or subject to any warranty claims.

- Use soap water or other water-soluble, mild cleaning agents with a pH value between 6 and 8 for cleaning the centrifuge and accessories (see also).
- Avoid corrosive and aggressive substances.
- Do not use solvents.
- Do not use agents with abrasive particles.
- Do not expose the centrifuge and rotors to intensive UV radiation or thermal stress (e.g. by heat generators).

8.1 Maintenance

8.1.1 Centrifuge

- Unplug the mains power plug before cleaning.
- Carefully remove all liquids, including water and particularly all the solvents, acids, and alkaline solutions from the rotor chamber using a cloth in order to avoid damage to the motor bearings.
- If the centrifuge has been contaminated with toxic, radioactive, or pathogenic substances, clean the rotor chamber immediately with a suitable decontamination agent (depending on the type of contamination).



WARNING

Take suitable precautions for your own safety if there is a risk of toxic, radioactive, or pathogenic contamination.

- Grease the motor shaft slightly after cleaning (grease for load-bearing bolts part no. 70284).

8 Maintenance and service

8.1.2 Accessories



CAUTION

For the care of the accessories, special safety measures must be considered as these are measures that will ensure operational safety at the same time!

- Immediately rinse off the rotor, buckets, or accessories under running water if they have come into contact with any liquids that may cause corrosion. Use a brush for test tubes in order to clean the bores of angle rotors. Turn the rotor upside down and allow it to dry completely.
- Clean the accessories outside the centrifuge once a week or preferably after each use. Adapters should be removed, cleaned and dried.



CAUTION

Do not clean the accessories in a dishwasher!

Cleaning in a dishwasher removes the anodised coating; the result is cracking in areas that are subject to stress.

- If the rotors or accessories have been contaminated with toxic, radioactive, or pathogenic substances, clean them immediately with a suitable decontamination agent (depending on the type of contamination). Take suitable precautions for your own safety if there is a risk of toxic, radioactive, or pathogenic contamination.
- Dry the accessories with a soft cloth or in a drying chamber at approx. 50°C.

8.1.2.1 Plastic accessories

The chemical resistance of plastic decreases with rising temperatures (see chapter 11.5 - "Resistance data").

- If solvents, acids, or alkaline solutions have been used, clean the plastic accessories thoroughly.



WARNING

Plastic accessories must not be greased!

8.1.3 Rotors, buckets and carriers

Rotors, buckets and carriers are produced with the highest precision, in order to withstand the permanent high stress from high gravitational fields. Chemical reactions as well as stress-corrosion (combination of oscillating pressure and chemical reaction) can affect or destroy the metals. Barely detectable cracks on the surface can expand and weaken the material without any visible signs.

- Check the material regularly (at least once a month) for
 - cracks
 - visible damage of the surface
 - pressure marks
 - signs of corrosion
 - other changes.

- Check the bores of the rotors and multiple carriers.
- Replace any damaged components immediately for your own safety.
- Grease the rotor tie-down screw after cleaning with grease for load bearing bolts (part no. 70284) and spread the grease with a cloth.

8.1.4 Load bearing bolts

Only greased load bearing bolts ensure the even swinging of the buckets and, therefore, the quiet run of the centrifuge. Non-greased bolts can lead to a system shut-down due to imbalances.

Apply a small quantity of grease (part no. 70284) to the load bearing bolts of the rotor and buckets after each cleaning.

8 Maintenance and service

8.1.5 Glass breakage



CAUTION

In the case of glass breakage, immediately remove all glass particles (e.g. with a vacuum cleaner). Replace the rubber cushions since even thorough cleaning will not remove all glass particles.

Glass particles will damage the surface coating (e.g. anodising) of the buckets, which will then lead to corrosion.

Glass particles in the rubber cushions of the buckets will cause glass breakage again.

Glass particles on the pivot bearing of the load-bearing bolts prevent the buckets and carriers from swinging evenly, which will cause an imbalance.

Glass particles in the rotor chamber will cause metal abrasion due to the strong air circulation. This metal dust will not only pollute the rotor chamber, rotor, and materials to be centrifuged but also damage the surfaces of the accessories, rotors, and rotor chamber.

In order to completely remove the glass particles and metal dust from the rotor chamber:

- Grease the upper third of the rotor chamber with e.g. Vaseline.
- Then, let the rotor rotate for a few minutes at a moderate speed (approx. 2000 rpm). The glass and metal particles will now collect at the greased part.
- Remove the grease with the glass and metal particles with a cloth.
- If necessary, repeat this procedure.

8.2 Sterilisation and disinfection of the rotor chamber and accessories

- Use commercially-available disinfectants such as, for example, Sagrotan[®], Buraton[®], or Terralin[®] (available at chemist's shops or drugstores).
- The centrifuge and the accessories consist of various materials. A possible incompatibility must be considered.
- Before using cleaning or decontamination agents that were not recommended by us, contact the manufacturer to ensure that such a procedure will not damage the centrifuge.
- For autoclaving, consider the continuous heat resistance of the individual materials (see chapter 8.2.1 - "Autoclaving").

Please contact us if you have any queries (see chapter 7.3 - "Service contact").



DANGER

If dangerous materials (e.g. infectious and pathogenic substances) are used, the centrifuge and accessories must be disinfected.

8.2.1 Autoclaving

The service life of the accessories essentially depends on the frequency of autoclaving and use.

- Replace the accessories immediately when the parts show changes in colour or structure or in the occurrence of leaks etc.
- During autoclaving, the caps of the tubes must not be screwed on in order to avoid the deformation of the tubes.

NOTE

It cannot be excluded that plastic parts, e.g. lids or carriers, may deform during autoclaving.

| Accessories | Max. temp. (°C) | Min. time (min) | Max. time (min) | Max. cycles |
|--|-----------------|-----------------|-----------------|-------------|
| Aluminium buckets | 134-138 | 3 | 5 | - |
| Aluminium rotors | 134-138 | 3 | 5 | - |
| Glass tubes | 134-138 | 3 | 40 | - |
| Polyallomer / polycarbonate rectangular carriers | 115-118 | 30 | 40 | - |
| Polyallomer / polycarbonate round carriers | 115-118 | 30 | 40 | - |
| Polyamide buckets | 115-118 | 30 | 40 | 10 |
| Polycarbonate / polyallomer lids for angle rotors | 115-118 | 30 | 40 | 20 |
| Polycarbonate tubes | 115-118 | 30 | 40 | 20 |
| Polyphenylsulfone (PPSU) caps for buckets | 134-138 | 3 | 5 | 100 |
| Polypropylene balance adapter for blood-bag systems | 115-118 | 30 | 40 | n.s. |
| Polypropylene copolymer tubes | 115-121 | 30 | 40 | 20 |
| Polypropylene rectangular carriers | 115-118 | 30 | 40 | - |
| Polypropylene rotors | 115-118 | 30 | 40 | 20 |
| Polypropylene round carriers | 115-118 | 30 | 40 | - |
| Polysulfone caps for buckets | 134-138 | 3 | 5 | 100 |
| Polysulfone lids for angle rotors | 134-138 | 3 | 5 | 100 |
| Rubber adapters | 115-118 | 30 | 40 | - |
| Stainless-steel balance weight for blood-bag systems | 121 | 30 | 30 | n.s. |
| Teflon tubes | 134-138 | 3 | 5 | 100 |

8 Maintenance and service

8.3 Service



DANGER

In the event of service work that requires the removal of the panels, there is a risk of electric shock or mechanical injury. Only qualified specialist personnel is authorised to perform this service work.

The centrifuge is subject to high mechanical stress. In order to be able to withstand this high level of stress, high-quality components were used during the production of the centrifuge. Nevertheless, wear cannot be excluded and it may not be visible from the outside. Especially the rubber parts that are – among other things – part of the motor suspension, are subject to ageing.

This is why we recommend having the centrifuge checked by the manufacturer during an inspection once per year in the operating state and once every three years in the dismantled state. Rubber parts should be replaced after three years.

Information and appointments:

In Germany:

Contact

Sigma Laborzentrifugen GmbH

An der Unteren Söse 50

37520 Osterode (Germany)

Tel. +49 (0) 55 22 / 50 07-44 44

E-mail: support.lab@sigma-zentrifugen.de

Outside Germany:

Contact our agency in your country. All agencies are listed at www.sigma-zentrifugen.de → [Sales Partners]



NOTE

- If you would like to utilise our service, please state the type of your centrifuge and its serial number.

8.4 Return of defective parts

Although we exercise great care during the production of our products, it may be necessary to return a unit or accessory to the manufacturer.

In order to ensure the quick and economical processing of returns of centrifuges, spare parts, or accessories, we require complete and extensive information concerning the process. Please fill in the following forms completely, sign them, enclose them with the return package, and send them together with the product to:

Sigma Laborzentrifugen GmbH
An der Unteren Söse 50
37520 Osterode (Germany)

1. Declaration of decontamination

As a certified company and due to the legal regulations for the protection of our employees and of the environment, we are obliged to certify the harmlessness of all incoming goods. For this purpose, we require a declaration of decontamination.

- The form must be filled in completely and signed by authorised and specialised personnel only.
- Affix the original form in a clearly visible manner to the outside of the packaging.



NOTE

We will return the unit if no declaration of decontamination is provided!

2. Form for the return of defective parts

This form is for the product-related data. They facilitate the assignment, and they enable the quick processing of the return. If several parts are returned together in one packaging, please enclose a separate problem description for every defective part.

- A detailed problem description is necessary in order to perform the repair quickly and economically.



NOTE

If the form does not include a description of the malfunction, neither a refund nor a credit note can be issued. In this case, we reserve the right to return the parts to you at your expense.

- Upon request, we will prepare and submit to you a cost estimate prior to performing the repair. Please confirm such cost estimate within 14 days. If the cost estimate has still not been confirmed after 4 weeks, we will return the unit. Please note that you must bear the incurred costs.

8 Maintenance and service



The unit must be packaged in a transport-safe manner. Please use the original packaging, if at all possible.
If the product is dispatched to us in unsuitable packaging, you will be charged the cost for returning it to you in new packaging.

The forms can be downloaded online from
www.sigma-zentrifugen.de → [Service] → [Overhaul and repair].

9 Disposal

9.1 Disposal of the centrifuge



In accordance with the directive 2002/96/EC, SIGMA centrifuges are marked with the symbol shown to the left. This symbol means that it is not permissible to dispose of the unit among household waste.

- You can return these centrifuges free of cost to Sigma Laborzentrifugen GmbH.
- Ensure that the unit is decontaminated. Fill in a declaration of decontamination (see chapter 8.4 - "Return of defective parts").
- Comply with any other applicable local rules and regulations.

9.2 Disposal of the packaging

- Use the packaging to return the centrifuge for disposal or
- dispose of the packaging, after having separated the individual materials.
- Comply with all local rules and regulations.

10 Technical data

10 Technical data

| | |
|---------------------------------|--|
| Manufacturer | Sigma Laborzentrifugen GmbH An der Unteren Söse 50 37520 Osterode (Germany) |
| Type: | 6-16S |
| <u>Connection requirements</u> | |
| Electr. connection: | see name plate |
| Protection class: | I |
| IP code: | 20 |
| Connected load (kVA): | 1.9 |
| Power consumption (kW): | 1.3 |
| Max. current consumption (A): | 6.0 (at 220-240 V / 50 Hz) 12.0 (at 120 V / 60 Hz) |
| Input fuse (AT): | 16.0 (at 220-240 V / 50 Hz), temperature fuses |
| <u>Performance data</u> | |
| Max. speed (rpm): | 13,500 |
| Max. capacity (ml): | 3,200 |
| Max. gravitational field (x g): | 20,376 |
| Max. kin. energy (Nm): | 105,901 |
| <u>Other parameters</u> | |
| Time range: | 10 sec – 99 h 59 min, short run, continuous run |
| Storage locations: | 60 |
| <u>Physical data</u> | |
| Height (mm): | 483 |
| Height with open lid (mm): | 990 |
| Width (mm): | 581 |
| Depth (mm): | 711 |
| Weight (kg): | 116 |
| Noise level (dB(A)): | < 73 (at maximum speed) |

10.1 Ambient conditions

- The figures are valid for an ambient temperature of $+23^{\circ}\text{C} \pm 2^{\circ}\text{C}$ and a nominal voltage $\pm 10\%$.



NOTE

At a nominal voltage of 100V or 200V, a tolerance of +10% / -5% applies.

- For indoor use only.
- Allowable ambient temperature $+5^{\circ}\text{C}$ to $+40^{\circ}\text{C}$.
- Max. relative humidity of air 80% up to 31°C with a linear decrease to 50% relative humidity of air at 40°C .
- Maximum altitude 2,000 m above sea level.

10.2 Technical documentation

For environmental reasons, the comprehensive technical documentation of the centrifuge (e.g. circuit diagrams) and the safety data sheets of the manufacturers of refrigerant and lubricants are not attached to this documentation.

You can order these documents from our service department.

11 Appendix

11 Appendix

11.1 Range of accessories

| Part no. | Description | Max. speed (rpm) | Max. gravitational field (x g) |
|----------|--|-------------------------|--------------------------------|
| 11118 | Swing-out rotor for microtiter plates, Biosafe with certificate, incl. 1 set carriers no. 13218, with 1 set caps no. 17108, incl. plate holder no. 17978, Radius max. 15.1 cm, radius min. 5.8 cm max. height of plates 80 mm,max. load per bucket approx. 520 g | 5 700 | 5 485 |
| 11148 | Swing-out rotor 32 x 1.5/2.0 ml, incl. 4 sets buckets no. 13124, for e.g. reaction vials no. 15008, 15040, incl. hermetic aluminium lid no. 17880 Radius max. 8.4 cm, radius min. 4.4 cm | 12 000 | 13 523 |
| 11150 | Swing-out rotor, 4 place, for buckets no. 13215, 13220, 13221, 13233, 13234, 13235, 13236, 13420, 13525 and 13550 | | |
| 11151 | Swing-out rotor 48 x 15 ml, complete, no. 11150, incl. 2 sets rectangular buckets no. 13215, 2 sets rectangular carriers no. 18015, and 48 PPCO-tubes 15 ml no. 15023 Radius max. 18.2 cm, radius min. 8.8 cm | 4 500 | 4 120 |
| 11152 | Swing-out rotor 96 x 15 ml complete, no. 11150, incl. 1 set double rectangular buckets no. 13420, 4 sets rectangular carriers no. 18015 and 96 PPCO-tubes 15 ml no. 15023 Radius max. 19.3 cm, radius min. 10.5 cm | 4 200 | 3 806 |
| 11156 | Swing-out rotor, 6 place, for buckets no. 13127 | | |
| 11157 | Swing-out rotor 72 x 15 ml, complete, no. 11156, incl. 3 sets rectangular buckets no. 13127, 3 sets rectangular carriers no. 18015, and 72 PPCO-tubes 15 ml no. 15023 Radius max. 19.1 cm, radius min. 9.7 cm | 4 500 | 4 324 |
| 11165 | Swing-out rotor, 4 place, for glass tubes for mineral oil bucket no. 13113: Radius max. 21.3 cm, radius min. 1.3 cm bucket no. 13114: Radius max. 19.1 cm, radius min. 2.8 cm bucket no. 13116: Radius max. 17.3 cm, radius min. 1.6 cm | 3 000 3 000 3 000 | 2 143 1 922 1 741 |
| 11166 | Swing-out rotor 4 x 100 ml complete, no. 11165, incl. 2 sets buckets no. 13113, 4 mineral oil glass tubes 8" following former ASTM D91/96 no. 15130 and 2 sets adapters no. 16103, (13113 sealable with cap no. 17107) Radius max. 21.3 cm, radius min. 1.3 cm | 3 000 | 2 143 |
| 11650 | Swing-out rotor, 4 place, for buckets no. 13421, 13450 13621, 13625, 13635, 13650 | | |
| 11651 | Swing-out rotor 48 x 15 ml culture tubes complete, no. 11650, incl. 2 sets buckets no. 13650, 2 sets adapters no. 17659 and 48 tubes 15 ml no. 15115 Radius max. 21.2 cm, radius min. 7.0 cm | 4 200 | 4 181 |
| 11660 | Swing-out rotor, stainless steel, 4 place, for buckets 13421, 13450, 13621, 13625, 13635, 13650 | | |
| 12130 | Angle rotor 30 x 1.5/2.0 ml, for e.g. reaction vials no. 15008, 15040, incl. hermetic aluminium lid no. 17844 Radius max. 10.0 cm, radius min. 6.7 cm, angle 45° | 13 500 | 20 376 |

11 Appendix

| Part no. | Description | Max. speed (rpm) | Max. gravitational field (x g) |
|----------|---|------------------|--------------------------------|
| 12168 | Angle rotor 20 x 10 ml, for tubes no. 15000, 15010, 15039, incl. hermetic aluminium lid no. 17846 Radius max. 9.8 cm, radius min. 5.8 cm, angle 25° | 12 500 | 17 119 |
| 12170 | Angle rotor for 12 x 15 ml culture tubes e.g. no. 15115, incl. hermetic aluminium lid no. 17859 Radius max. 10.0 cm, radius min. 4.6 cm, angle 25° | 12 500 | 17 469 |
| 12172 | Angle rotor 12 x 30 ml, for tubes no. 15029, 15030, 15032, incl. hermetic aluminium lid no. 17845 Radius max. 11.0 cm, radius min. 5.1 cm, angle 30° | 12 500 | 19 216 |
| 12174 | Angle rotor for 24 x 15 ml culture tubes e.g. no. 15115, 2 lines with same RCF-value, incl. hermetic aluminium lid no. 17883 Radius max. 12.6 cm, radius min. 6.3 cm, angle 30°/40° | 10 500 | 15 531 |
| 12265 | Angle rotor 6 x 85 ml, Biosafe with certificate, for tubes no. 13085, 15076, 15080, incl. bayonet lid no. 17607, Radius max. 10.6 cm, radius min. 3.5 cm, angle 25° | 12 500 | 18 517 |
| 12266 | Angle rotor 8 x 50 ml, Biosafe with certificate, for tubes no. 13055, 15051, 15052, incl. bayonet lid no. 17605, Radius max. 10.0 cm, radius min. 3.7 cm, angle 25° | 12 500 | 17469 |
| 12269 | Angle rotor for 8 x 50 ml, Biosafe with certificate, culture tubes e.g. no. 15151, incl. bayonet lid no. 17604, Radius max. 10.4 cm, radius min. 4.3 cm, angle 25° | 12 500 | 18 168 |
| 12356 | Angle rotor 6 x 250 ml, Biosafe with certificate, for bottles no. 13255, 15247, 15249 and adapters 14122 - 14134, incl. bayonet lid no. 17603, Radius max. 14.5 cm, radius min. 3.9 cm, angle 30° | 9 000 | 13 131 |
| 12449 | Angle rotor 48 x 1.5/2.0 ml, Biosafe with certificate, reaction vials no. e.g. 15008, 15040, incl. bayonet lid no 17612, Radius max. 10.0 cm, radius min. 6.5 cm | 13 500 | 20 376 |
| 12450 | Angle rotor 24 x 5 ml Eppendorf reaction caps, Biosafe with certificate, incl. bayonet lid no. 17614, software version 50 or higher Radius max. 11.6 cm, radius min. 7.5 cm | 13 000 | 21 917 |
| 12600 | Angle rotor 6 x 500 ml, Biosafe with certificate, for bottles no. 13507, 15508 and adapters 14144 - 14155, incl. bayonet lid no. 17600, incl. torque wrench set 17060 Radius max. 16.7 cm, radius min. 4.3 cm, angle 30° | 8 000 | 11 949 |
| 13113 | Bucket sealable with cap no. 17107, for 1 glass tube for mineral oil 100 ml, 8", Ø 37 x 203 mm, following former ASTM D 91/96 no. 15130, incl. adapter no. 16103, 1 set = 2 pcs. | | |
| 13114 | Bucket for 1 glass tube for mineral oil 100 ml, 6", Ø 44 x 165 mm, following former ASTM D 96 no. 15132, incl. rubber cushion no. 16104, 1 set = 2 pcs. | | |
| 13116 | Bucket for 1 glass tube for mineral oil 100 ml, pear-shaped, Ø 59 x 160 mm, following former ASTM D 96 no. 15131, incl. rubber cushion no. 16106, 1 set = 2 pcs. | | |
| 13127 | Rectangular bucket, sealable with cap no. 17112, for rectangular adapters no. 18000 - 18200, max. tube length 115 mm, 1 set = 2 pcs. | 4 500 | 4 324 |
| 13215 | Rectangular bucket, suitable for rectangular adapters no. 18000 - 18200, sealable with cap no. 17112, max. tube length 115 mm, 1 set = 2 pcs. | | |
| 13218 | Bucket for microtiter plates, Biosafe certificate, sealable with cap no. 17108, incl. plate holder no. 17978, max. height of plates approx. 80 mm, 1 set = 2 pcs. | | |

11 Appendix

| Part no. | Description | Max. speed (rpm) | Max. gravitational field (x g) |
|----------|--|------------------|--------------------------------|
| 13220 | Bucket for microtiter plates, max. height of plates 51 mm, 1 set = 2 pcs., max. permissible data with rotor 11150: Radius max. 16.0 cm, radius min. 11.3 cm | 4 100 | 3 007 |
| 13221 | Bucket for microtiter plates, incl. plate holder no. 17979, max. height of plates 56 mm, 1 set = 2 pcs., max. permissible data with rotor 11150: Radius max. 16.0 cm, radius min. 10.0 cm | 4 500 | 3 622 |
| 13233 | Multiple carrier for 50 tubes approx. 5 ml, max. Ø 12.5 x 70 - 90 mm, e.g. RIA tube no. 15060, 1 set = 2 pcs. | | |
| 13234 | Multiple carrier for 4 x 100 ml, for tubes max. Ø 45 x 92 - 100 mm, e.g. no. 15100, 15102, 15103, 15106, incl. 2 sets rubber cushions no. 16051, 1 set = 2 pcs. Radius max. 17.8 cm, radius min. 7.8 cm | 4 300 | 3 680 |
| 13235 | Multiple carrier for 7 culture tubes 50 ml no. 15151, 1 set = 2 pcs. max. Radius 19.0 cm, min. Radius 9.3 cm | 4 500 | 4 302 |
| 13236 | Multiple carrier for 12 culture tubes 15 ml no. 15115, 1 set = 2 pcs. max. Radius 18.8 cm, min. Radius 9.6 cm | 4 500 | 4 256 |
| 13420 | Double rectangular bucket, sealable with cap no. 17114, for rectangular carriers no. 18002 - 18250, 18615, 18650, max. tube length 110 mm, 1 set = 4 pcs. Radius max. 19.3 cm, radius min. 10.5 cm Attention! The buckets are dynamically balanced must be installed in sets of 4 and in the prescribed order (see chapter 6.2.2.3 - "Installation of accessories") | 4 200 | 3 806 |
| 13421 | Bucket for microtiter plates, max. height of plates 60 mm, incl. plate holder no. 17979, 1 set = 4 pcs. Radius max. 15.7 cm, radius min. 9.4 cm | 4 200 | 3 096 |
| 13450 | Round bucket, Biosafe sealable with cap no. 17170, for round adapters Ø 100, (no. 17649 - 17699), for 650 ml tube no. 13456, adapter no. 13654, max. tube length 140 mm, 1 set = 2 pcs. Radius max. 18.8 cm, radius min. 7.0 cm | 4 500 | 3 708 |
| 13550 | Round bucket, for round carriers Ø 85 mm no. 17344 - 17404, adapter 13555, 500 ml bottle no. 15501, 750 ml bottles no. 15751, sealable with cap no. 17134, 17135, max. tube length 155 mm, 1 set = 2 pcs. Radius max. 21.4 cm, radius min. 8.4 cm | 4 500 | 4 845 |
| 13555 | Adapter for 1 bottle 500 ml, max. Ø 69,6 x 165 mm, e.g. no. 15508, 1 set = 2 pcs. | | |
| 13621 | Bucket for microtiter plates, max. height of plates 86 mm, incl. plate holder no. 17980, 1 set = 4 pcs. Radius max. 18.2 cm, radius min. 9.6 cm Attention! The buckets are dynamically balanced must be installed in sets of 4 and in the prescribed order (see chapter 6.2.2.3 - "Installation of accessories") | 4 200 | 3 589 |
| 13625 | Bucket for 1 blood bag system, volume of the bucket approx. 1000 ml, incl. polypropylene adapter no. 13627 for standard bags, 1 set = 2 pcs. Radius max. 21.0 cm, radius min. 6.4 cm | 4 200 | 4 142 |
| 13627 | Polypropylene adapter for standard blood bags, 1 set = 2 pcs. | | |
| 13635 | Aluminium bucket for carriers for culture tubes no. 18604 - 18607, 1 set = 2 pcs. | 4 200 | 3 846 |

11 Appendix

| Part no. | Description | Max. speed (rpm) | Max. gravitational field (x g) |
|----------|--|------------------|--------------------------------|
| 13650 | Round bucket, Biosafe sealable with cap no. 17170, for round adapters Ø 100 mm, (no. 17651 - 17699), for 800 ml tube no. 13656, adapter no. 13654, 13655, max. tube length 145 mm, 1 set = 2 pcs. Radius max. 21.2 cm, radius min. 7.0 cm | 4 200 | 4 181 |
| 13654 | Adapter for 1 bottle 500 to 750 ml, Ø 85 x 130 - 173 mm, e.g. no. 15501, 15751, (in 13450 only, 15501), 1 set = 2 pcs. | | |
| 13655 | Adapter for 1 bottle 500 ml, max. Ø 69.5 x 165 mm, e.g. no. 13507 with 17256, 15508, 1 set = 2 pcs. | | |

Adapters and stainless steel tubes

| Part no. | Description |
|----------|---|
| 13000 | Adapter for reaction vials 0.25/0.4 ml no. 15014, suitable for 11148, 12130, 12201, 17353, 17653, 18002, 18003, 1 Set = 2 Stück |
| 13002 | Adapter for reaction vials 0.5/0.75 ml, Ø 7.9/10 x 28/31 mm, e.g. no. 15005, suitable for 11148, 12130, 12201, 17353, 17653, 18002, 18003, 1 set = 2 pcs. |
| 13021 | Adapter for PCR-tube 0.2 ml, e.g. no. 15042, suitable for 11148, 12130, 12201, 17353, 17653, 18002, 18003, 1 set = 2 pcs. |
| 13055 | Stainless steel tube 50 ml, Ø 28.5 x 101.5 mm, sealable with cap no. 17054, suitable for 12166, 13082, 17376, 17676, 18051 |
| 13062 | Adapter for 1 Greiner tube 15 ml, Ø 17/22 x 95 - 100 mm, suitable for 12165, 1 set = 2 pcs |
| 13079 | Bottomadapter for 1 tube 50 ml, e.g. no. 15051, 15052, suitable for 12169, 1 set = 2 pcs. |
| 13080 | Adapter for 1 culture tube 50 ml, e.g. no. 15151, suitable for 12165, 1 set = 2 pcs. |
| 13081 | Adapter for 1 culture tube 15 ml, e.g. no. 15115, suitable for 12165, 1 set = 2 pcs. |
| 13082 | Adapter for 1 tube 50 ml, max. Ø 28.8 x 105 - 115 mm, e.g. no. 13055, 15051, 15052, suitable in 12165, 1 set = 2 pcs. |
| 13083 | Adapter for 1 tube 30 ml, max. Ø 25.5 x 90 - 100 mm, e.g. no. 15029, 15030, 15032, suitable for 12165, 1 set = 2 pcs. |
| 13084 | Adapter, for 2 tubes 10 ml, Ø 16/17.5 x 75 - 90 mm, e.g. no. 15000, 15010, 15039, suitable for 12165, 1 set = 2 pcs. |
| 13085 | Stainless steel tube 85 ml, Ø 38 x 103 mm, sealable with cap no. 17185, suitable for 12265, 17385, 18085 |
| 13255 | Stainless steel bottle 250 ml, Ø 61.4 x 125 mm, sealable with cap no. 17256, suitable for 12256-H, 17347, 17698 |
| 13507 | Stainless steel bottle 500 ml, Ø 69.5 x 152 mm, sealable with cap no. 17256, suitable for 13655 |
| 13656 | Polypropylene tube with flat bottom, 800 ml, Ø 100 x 135 mm, sealable with cap 17123 suitable for 13650 |

The complete list of accessories can be downloaded from www.sigma-zentrifugen.de.

11 Appendix

11.1.1 Maximum speed for tubes

Some tubes, such as centrifuge glass tubes, microtubes, culture tubes, fluoropolymer tubes and especially high-volume tubes can be used in our rotors, buckets, and adapters at higher speeds than their breaking limit.

- Always fill the tubes up to their useful volume (= the volume that is stated for the tube).
- When using glass tubes, the maximum value of 4,000 x g must not be exceeded (except special high-strength glass tubes; please refer to the information provided by the manufacturer).
- When installing the 500 ml bottles use the supplied supporting rings
- Attention: At speeds above 8,000 rpm, there is an increased risk of breakage, in particular for 250 ml bottles.

11.1.2 Rotor radii

The information in the accessories table concerning the radius refers to the values of the respective rotor as shown below. The radius calculation is described in chapter 2.2.2.1 - "Speed, radius, and relative centrifugal force".

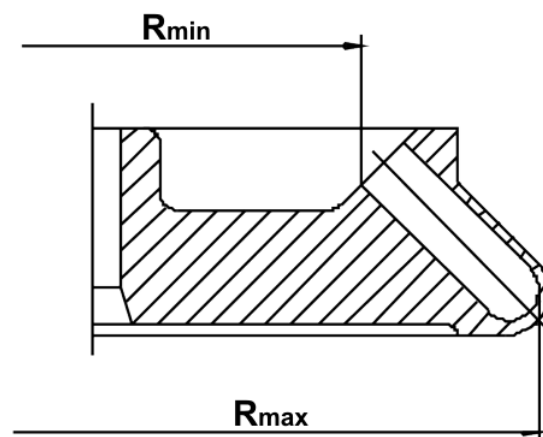

Fig. 31: Minimum and maximum radius of an angle rotor

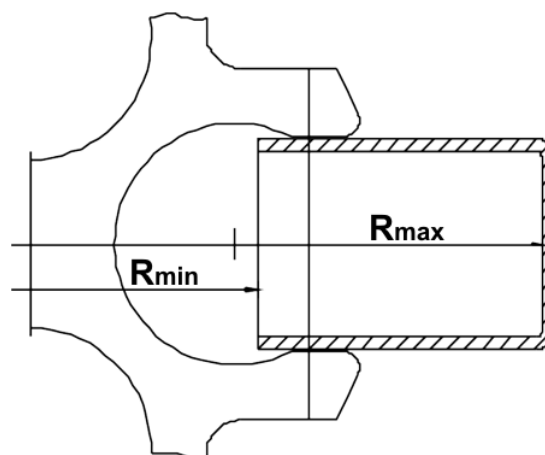

Fig. 32: Minimum and maximum radius of a swing-out rotor

11.2 Speed-gravitational-field-diagram

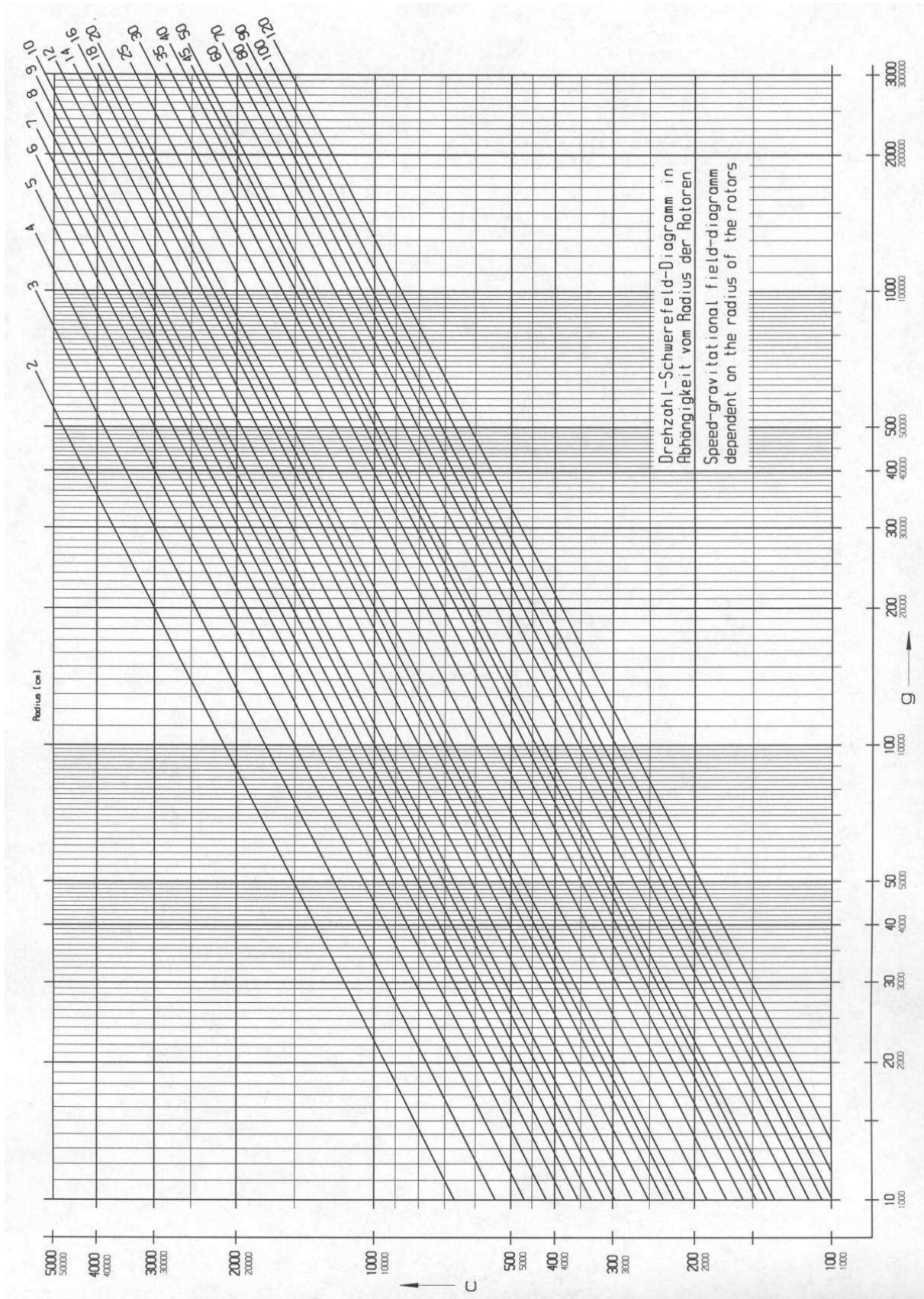

Fig. 33: Speed-gravitational-field-diagram

11 Appendix

11.3 Acceleration and deceleration curves

Linear as well as quadratic curves are numbered in the direction of increasing acceleration (from right to left).

The deceleration curves are inverted images of the acceleration curves and are assigned the same numbers. An exception is curve 0. It decelerates brakeless (spin-out).

In general, the runtime, until the set speed is reached, depends on the moment of inertia of the rotor.

Linear curves

The slope of the fixed acceleration curves defines the time that is required to accelerate the rotor by 1,000 rpm.

Curve 9 is a special case compared to the other curves. The centrifuge accelerates with maximum power. The runtime, until the set speed is reached, depends solely on the moment of inertia of the rotor.

| Linear curve no. | Slop |
|------------------|-----------------|
| 0 | 4 [rpm/sec] |
| 1 | 6 [rpm/sec] |
| 2 | 8 [rpm/sec] |
| 3 | 17 [rpm/sec] |
| 4 | 25 [rpm/sec] |
| 5 | 33 [rpm/sec] |
| 6 | 50 [rpm/sec] |
| 7 | 100 [rpm/sec] |
| 8 | 200 [rpm/sec] |
| 9 | 1.000 [rpm/sec] |

Fig. 34: Slope of linear curves

Quadratic curves

Curve 19 is a special case compared to the other curves. The centrifuge accelerates with maximum power. The runtime depends solely on the moment of inertia of the rotor.

| Quadratic curve no. | Time until 1,000 rpm | Slope as of 1,000 rpm |
|---------------------|----------------------|-----------------------|
| 10 | 500 sec | 4 [rpm/sec] |
| 11 | 333 sec | 6 [rpm/sec] |
| 12 | 250 sec | 8 [rpm/sec] |
| 13 | 118 sec | 17 [rpm/sec] |
| 14 | 80 sec | 25 [rpm/sec] |
| 15 | 60 sec | 33 [rpm/sec] |
| 16 | 40 sec | 50 [rpm/sec] |
| 17 | 20 sec | 100 [rpm/sec] |
| 18 | 10 sec | 200 [rpm/sec] |
| 19 | 2 sec | 1.000 [rpm/sec] |

Fig. 35: Slope of quadratic curves

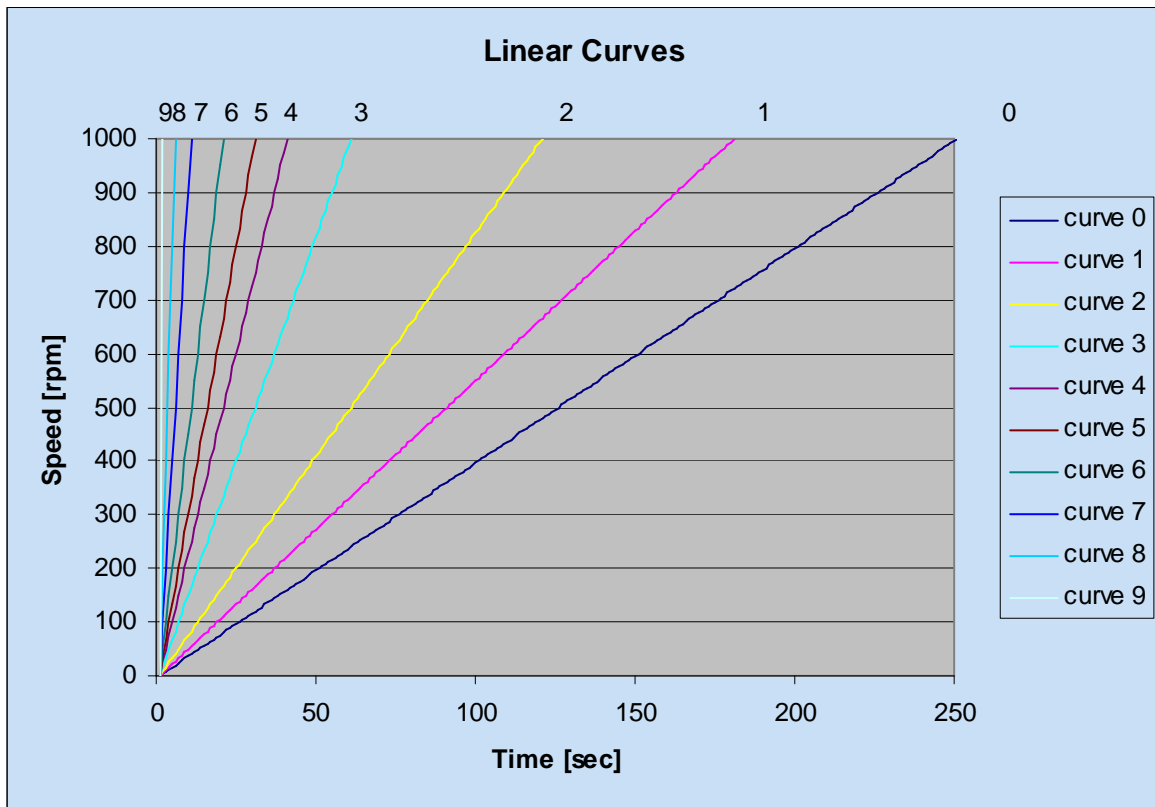

Fig. 36: Diagram of linear curves

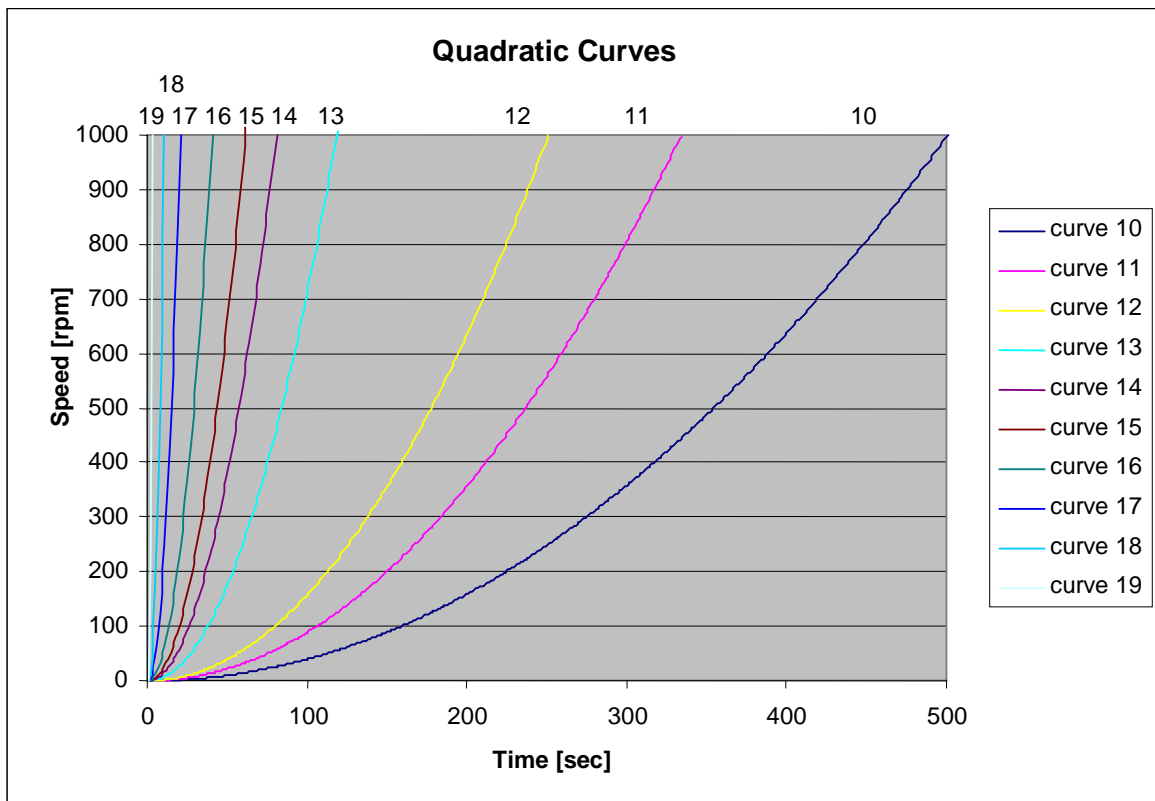



Fig. 37: Diagram of quadratic curves

11 Appendix

11.4 Table of the service life of rotors and accessories

| Rotors and accessories with a different service life | |  | | | |
|--|--------|--|-------------|---|--|
| If no other data concerning the service life are engraved on the rotor or accessory, rotors and buckets must be checked by the manufacturer after 10 years. After 50,000 cycles, rotors must be scrapped for safety reasons. | | | | | |
| Rotor / bucket | Cycles | Service life ("Exp.Date") | Autoclaving | Suitable for centrifuge | Remarks |
| 9100 | 15,000 | | | 4-15C, 4K15C, 4-16, 4-16S, 4-16K, 4-16KS, 6-15, 6K15, 6-16, 6-16K | without engraving, only "spincontrol professional" and "spincontrol S" |
| 11026 | | 7 years | | 1-14, 1-14K | |
| 12033 | | 5 years | | 1-16 Edition, 1-16K Edition | |
| 12082 | | 7 years | | 1-14, 1-14K | |
| 12083 | | 7 years | | 1-14, 1-14K | |
| 12084 | | 7 years | | 1-14, 1-14K | |
| 12085 | | 7 years | | 1-14, 1-14K | |
| 12092 | | 5 years | 20x | 1-14, 1-14K | |
| 12093 | | 5 years | 20x | 1-14, 1-14K | |
| 12094 | | 5 years | 20x | 1-14, 1-14K | |
| 12096 | | 5 years | 20x | 1-14, 1-14K | |
| 12101 | | 5 years | 20x | 1-15, 1-15K, 1-15P, 1-15PK | |
| 12124 | | 5 years | 20x | 1-15, 1-15K, 1-15P, 1-15PK | |
| 12126 | | 5 years | 20x | 1-15, 1-15K, 1-15P, 1-15PK | |
| 12134 | | 5 years | 20x | 1-16, 1-16K | |
| 12135 | | 5 years | 20x | 1-16, 1-16K | |
| 12137 | | 5 years | 20x | 1-16, 1-16K | |
| 12500 | | 7 years | | 6-15, 6K15, 6-16, 6-16K | |
| 12600 | | 7 years | | 6-16S, 6-16KS | |
| 13218 | 20,000 | | | 4-16, 4-16S, 4-16K, 4-16KS, 6-16, 6-16S, 6-16K, 6-16KS | |
| 13296 | | 5 years | 10x | 2-6, 2-6E, 2-7 | |
| 13299 | | 5 years | 10x | 2-6, 2-6E, 2-7, 2-16P, 2-16KL, 2-16KHL | |
| 13635 | 25,000 | | | 6-16, 6-16K, 6-16S, 6-16KS | |
| 13845 | 20,000 | | | 8K, 8KS | |
| 13850 | 10,000 | | | 8K, 8KS, 8KBS | |
| 13860 | 35,000 | | | 8K, 8KS, 8KBS | |
| 13864 | 1,000 | | | 8K, 8KS | without engraving |
| 13865 | 1,000 | | | 8K, 8KS | without engraving |
| 13866 | 1,000 | | | 8K, 8KS | without engraving |

11.5 Resistance data

i

NOTE

The data refer to resistance at 20°C.

| - no data 1 resistant 2 practically resistant 3 partially resistant 4 not resistant | Medium | Formula | Concentration [%] | High Density Polyethylene | Polyamide | Polycarbonate | Polyoxymethylene | Polypropylene | Polysulfone | Polyvinyl chloride, hard | Polyvinyl chloride, weak | Polytetrafluorethylene | Acrylonitrile-butadiene- caoutchouc | Aluminium |
|---|------------------------------|---|----------------------|------------------------------|-----------|---------------|------------------|---------------|-------------|--------------------------|--------------------------|------------------------|--|-----------|
| | | | | HDPE | PA | PC | POM | PP | PSU | PVC | PVC | PTFE | NBR | AL |
| | Acetaldehyde | C ₂ H ₄ O | 40 | 3 | 2 | 4 | 2 | 3 | 4 | 4 | - | 1 | 4 | 1 |
| | Acetamide | C ₂ H ₅ NO | saturated | 1 | 1 | 4 | 1 | 1 | 4 | 4 | - | 1 | - | 1 |
| | Acetone | C ₃ H ₆ O | 100 | 1 | 1 | 4 | 1 | 1 | 4 | 4 | - | 1 | 4 | 1 |
| | Acrylonitrile | C ₃ H ₃ N | 100 | 1 | 1 | 4 | 3 | 3 | 4 | 4 | 4 | 1 | 4 | 1 |
| | Allyl alcohol | C ₃ H ₆ O | 96 | 1 | 3 | 3 | 2 | 2 | 2 | 2 | 4 | 1 | 1 | 1 |
| | Aluminium chloride | AlCl ₃ | saturated | 1 | 3 | 2 | 4 | 1 | - | 1 | - | 1 | 1 | 4 |
| | Aluminium sulfate | Al ₂ (SO ₄) ₃ | 10 | 1 | 1 | 1 | 3 | 1 | 1 | 1 | 1 | 1 | 1 | 1 |
| | Ammonium chloride | (NH ₄)Cl | aqueous | 1 | 1 | 1 | 2 | 1 | 1 | 1 | 1 | 1 | 1 | 3 |
| | Ammonium hydroxide | NH ₃ + H ₂ O | 30 | 1 | 3 | 4 | 1 | 1 | 2 | 1 | - | 1 | - | 1 |
| | Aniline | C ₆ H ₇ N | 100 | 1 | 3 | 4 | 1 | 2 | 4 | 4 | 4 | 1 | 4 | 1 |
| | Anisole | C ₇ H ₈ O | 100 | 3 | 4 | 4 | 1 | 4 | 4 | 2 | - | 1 | 4 | 1 |
| | Antimony trichloride | SbCl ₃ | 90 | 1 | 4 | 1 | 4 | 1 | - | 1 | - | 1 | - | 4 |
| | Benzaldehyde | C ₇ H ₆ O | 100 | 1 | 3 | 4 | 1 | 1 | 3 | 4 | 4 | 1 | 4 | 1 |
| | Benzene | C ₆ H ₆ | 100 | 3 | 2 | 4 | 1 | 3 | 4 | 4 | - | 1 | 4 | 1 |
| | Boric acid | H ₃ BO ₃ | aqueous | 1 | 3 | 1 | 2 | 1 | - | - | - | 1 | 1 | 1 |
| | Butyl acrylate | C ₇ H ₁₂ O ₂ | 100 | 1 | 2 | 4 | 2 | 3 | 4 | 4 | 4 | 1 | - | 1 |
| | Butyl alcohol, normal | C ₄ H ₁₀ O | 100 | 1 | 1 | 2 | 1 | 1 | 2 | 2 | 4 | 1 | 1 | 1 |
| | Calcium chloride | CaCl ₂ | alcoholic | 1 | 4 | 2 | 3 | 1 | - | - | 4 | 1 | 1 | 3 |
| | Carbon disulfide | CS ₂ | 100 | 4 | 3 | 4 | 2 | 4 | 4 | 4 | 4 | 1 | 3 | 1 |
| | Carbon tetrachloride (TETRA) | CCl ₄ | 100 | 4 | 4 | 4 | 2 | 4 | 4 | 4 | 4 | 1 | 3 | 1 |
| | Chlorine | Cl ₂ | 100 | 4 | 4 | 4 | 4 | 4 | 4 | 4 | 4 | 1 | - | 3 |
| | Chlorine water | Cl ₂ x H ₂ O | | 3 | 4 | 4 | 4 | 3 | - | 3 | 3 | 1 | - | 4 |
| | Chlorobenzene | C ₆ H ₅ Cl | 100 | 3 | 4 | 4 | 1 | 3 | 4 | 4 | 4 | 1 | 4 | 1 |
| | Chloroform | CHCl ₃ | 100 | 3 | 3 | 4 | 4 | 3 | 4 | 4 | 4 | 1 | 4 | 3 |

11 Appendix

| - no data 1 resistant 2 practically resistant 3 partially resistant 4 not resistant | Medium | Formula | Concentration [%] | High Density Polyethylene | Polyamide | Polycarbonate | Polyoxymethylene | Polypropylene | Polysulfone | Polyvinyl chloride, hard | Polyvinyl chloride, weak | Polytetrafluorethylene | Acrylonitrile-butadiene- caoutchouc | Aluminium |
|---|---------------------------------------|--|----------------------|------------------------------|-----------|---------------|------------------|---------------|-------------|--------------------------|--------------------------|------------------------|--|-----------|
| | | | | HDPE | PA | PC | POM | PP | PSU | PVC | PVC | PTFE | NBR | AL |
| | Chromic acid | CrO ₃ | 10 | 1 | 4 | 2 | 4 | 1 | 4 | 1 | - | 1 | 4 | 1 |
| | Chromic potassium sulphate | KCr(SO ₄) ₂ x 12H ₂ O | saturated | 1 | 2 | 1 | 3 | 1 | - | 1 | - | 1 | - | 3 |
| | Citric acid | C ₆ H ₈ O ₇ | 10 | 1 | 1 | 1 | 2 | 1 | 1 | 1 | 1 | 1 | 1 | 1 |
| | Citric acid | C ₆ H ₈ O ₇ | 50 | 1 | 3 | 1 | 2 | 1 | - | - | - | 1 | 1 | 1 |
| | Copper sulphate | CuSO ₄ x 5H ₂ O | 10 | 1 | 1 | 1 | 1 | 1 | 1 | 1 | 1 | 1 | 1 | 4 |
| | Cyclohexanol | C ₆ H ₁₂ O | 100 | 1 | 1 | 3 | 1 | 1 | 1 | 1 | 4 | 1 | 2 | 1 |
| | Decane | C ₁₀ H ₂₂ | 100 | - | 1 | 2 | 1 | 3 | - | - | - | 1 | 2 | 1 |
| | Diaminoethane | C ₂ H ₈ N ₂ | 100 | 1 | 1 | 3 | 1 | 1 | - | 3 | 4 | 1 | 1 | 1 |
| | Diesel fuel | — | 100 | 1 | 1 | 3 | 1 | 1 | - | 1 | 3 | 1 | 1 | 1 |
| | Dimethyl formamide (DMF) | C ₃ D ₇ NO | 100 | 1 | 1 | 4 | 1 | 1 | 4 | 3 | - | 1 | 3 | 1 |
| | Dimethyl sulfoxide (DMSO) | C ₂ H ₆ SO | 100 | 1 | 2 | 4 | 1 | 1 | 4 | 4 | - | 1 | - | 1 |
| | Dimethylaniline | C ₈ H ₁₁ N | 100 | - | 3 | 4 | 2 | 4 | - | - | - | 1 | - | 1 |
| | Dioxane | C ₄ H ₈ O ₂ | 100 | 2 | 1 | 4 | 1 | 3 | 2 | 3 | 4 | 1 | 3 | 1 |
| | Dipropylene glycol (mono)methyl ether | C ₄ H ₁₀ O | 100 | 3 | 1 | 4 | 1 | 4 | 4 | 4 | 4 | 1 | - | 1 |
| | Ethyl acetate | C ₄ H ₈ O ₂ | 100 | 1 | 1 | 4 | 1 | 1 | 4 | 4 | 4 | 1 | 4 | 1 |
| | Ethylene chloride | C ₂ H ₄ Cl ₂ | 100 | 3 | 3 | 4 | 1 | 3 | 4 | 4 | 4 | 1 | - | 1 |
| | Ferrous chloride | FeCl ₂ | saturated | 1 | 3 | 1 | 3 | 1 | 1 | 1 | 1 | 1 | - | 4 |
| | Formaldehyde solution | CH ₂ O | 30 | 1 | 3 | 1 | 1 | 1 | - | - | - | 1 | 2 | 1 |
| | Formic acid | CH ₂ O ₂ | 100 | 1 | 4 | 3 | 4 | 1 | 3 | 3 | 1 | 1 | 2 | 1 |
| | Furfural | C ₅ H ₄ O ₂ | 100 | 1 | 3 | 3 | 2 | 4 | - | - | - | 1 | 4 | 1 |
| | Gasoline | C ₅ H ₁₂ - C ₁₂ H ₂₆ | 100 | 2 | 1 | 3 | 1 | 3 | 3 | 2 | - | 1 | 1 | 1 |
| | Glycerol | C ₃ H ₈ O ₃ | 100 | 1 | 1 | 3 | 1 | 1 | 1 | 1 | 2 | 1 | 1 | 1 |
| | Heptane, normal | C ₇ H ₁₆ | 100 | 2 | 1 | 1 | 1 | 2 | 1 | 2 | 4 | 1 | 1 | 1 |
| | Hexane, n- | C ₆ H ₁₄ | 100 | 2 | 1 | 2 | 1 | 2 | 1 | 2 | 4 | 1 | 1 | 1 |
| | Hydrogen chloride | HCl | 5 | 1 | 4 | 1 | 4 | 1 | 1 | 1 | - | 1 | 2 | 4 |
| | Hydrogen chloride | HCl | concentrated | 1 | 4 | 4 | 4 | 1 | 1 | 2 | 3 | 1 | 4 | 4 |
| | Hydrogen peroxide | H ₂ O ₂ | 3 | 1 | 3 | 1 | 1 | 1 | 1 | 1 | - | 1 | 3 | 3 |
| | Hydrogen peroxide | H ₂ O ₂ | 30 | 1 | 4 | 1 | 4 | 1 | 1 | 1 | - | 1 | 3 | 3 |
| | Hydrogen sulphide | H ₂ S | 10 | 1 | 1 | 1 | 1 | 1 | 1 | 1 | 3 | 1 | 3 | 1 |
| | Iodine, tincture of | I ₂ | | 1 | 4 | 3 | 1 | 1 | - | 4 | 4 | 1 | 1 | 1 |

11 Appendix

| Medium | Formula | Concentration [%] | - no data | 1 resistant | 2 practically resistant | 3 partially resistant | 4 not resistant | High Density Polyethylene | Polyamide | Polycarbonate | Polyoxymethylene | Polypropylene | Polysulfone | Polyvinyl chloride, hard | Polyvinyl chloride, weak | Polytetrafluorethylene | Acrylonitrile-butadiene-caoutchouc | Aluminium |
|------------------------------|--|----------------------|-----------|-------------|-------------------------|-----------------------|-----------------|---------------------------|-----------|---------------|------------------|---------------|-------------|--------------------------|--------------------------|------------------------|------------------------------------|-----------|
| | | | HDPE | PA | PC | POM | PP | PSU | PVC | PVC | PTFE | NBR | AL | | | | | |
| Isopropyl alcohol | C ₃ H ₈ O | 100 | 1 | 1 | 1 | 1 | 1 | 1 | 1 | 1 | 1 | 1 | 1 | 1 | 4 | 1 | - | 2 |
| Lactic acid | C ₃ H ₆ O ₃ | 3 | 1 | 3 | 1 | 2 | 1 | 1 | 1 | 2 | 1 | 1 | 2 | - | 1 | 1 | 1 | 1 |
| Magnesium chloride | MgCl ₂ | 10 | 1 | 1 | 1 | 1 | 1 | 1 | 1 | 1 | 1 | 1 | 1 | 1 | 1 | 1 | 1 | 1 |
| Mercuric chloride | HgCl ₂ | 10 | 1 | 4 | 1 | 3 | 1 | 1 | 1 | 1 | 1 | 1 | 1 | 1 | 1 | 1 | 1 | 4 |
| Mercury | Hg | 100 | 1 | 1 | 1 | 1 | 1 | 1 | 1 | 1 | 1 | 1 | 1 | 1 | 3 | 1 | 1 | 3 |
| Methyl acetate | C ₃ H ₆ O ₂ | 100 | 1 | 1 | 4 | 2 | 1 | - | 4 | 4 | 1 | - | 4 | 4 | 1 | - | 1 | 1 |
| Methyl alcohol | CH ₄ O | 100 | 1 | 2 | 4 | 1 | 1 | 3 | 1 | 3 | 1 | 3 | 1 | 3 | 1 | 2 | 1 | 1 |
| Methyl benzene | C ₇ H ₈ | 100 | 3 | 1 | 4 | 1 | 3 | 4 | 4 | 4 | 1 | 4 | 1 | 4 | 1 | 4 | 1 | 1 |
| Methyl ethyl ketone (MEK) | C ₄ H ₈ O | 100 | 1 | 1 | 4 | 1 | 1 | 4 | 4 | 4 | 1 | 4 | 1 | 4 | 1 | 4 | 1 | 1 |
| Methylene chloride | CH ₂ Cl ₂ | 100 | 4 | 3 | 4 | 3 | 3 | 4 | 4 | 4 | 1 | - | 1 | 1 | - | 1 | 1 | 1 |
| Mineral oil | — | 100 | 1 | 1 | 1 | 1 | 1 | 1 | 1 | 1 | 1 | 1 | 1 | - | 1 | 1 | 1 | 1 |
| Nitric acid | HNO ₃ | 10 | 1 | 4 | 1 | 4 | 1 | 1 | 1 | 1 | - | 1 | 4 | - | 1 | 4 | 3 | 3 |
| Nitric acid | HNO ₃ | 100 | 4 | 4 | 4 | 4 | 4 | - | 4 | - | 1 | 4 | 1 | 1 | 1 | 4 | 1 | 1 |
| Nitrobenzene | C ₆ H ₅ NO ₂ | 100 | 3 | 4 | 4 | 3 | 2 | 4 | 4 | 4 | 1 | 4 | 1 | 4 | 1 | 4 | 1 | 1 |
| Oleic acid | C ₁₈ H ₃₄ O ₂ | 100 | 1 | 1 | 1 | 2 | 1 | - | 1 | - | 1 | 3 | 1 | 1 | 1 | 3 | 1 | 1 |
| Oxalic acid | C ₂ H ₂ O ₄ x 2H ₂ O | 100 | 1 | 3 | 1 | 4 | 1 | 1 | 1 | 1 | 1 | 1 | 1 | 1 | 1 | 2 | 1 | 1 |
| Ozone | O ₃ | 100 | 3 | 4 | 1 | 4 | 3 | 1 | 1 | 1 | - | 1 | 4 | 1 | 1 | 4 | 2 | 2 |
| Petroleum | — | 100 | 1 | 1 | 3 | 1 | 1 | 1 | 1 | 1 | 3 | 1 | 1 | 1 | 1 | 1 | 1 | 1 |
| Phenol | C ₆ H ₆ O | 10 | 1 | 4 | 4 | 4 | 1 | 4 | 1 | 3 | 1 | 3 | 1 | 3 | 1 | 3 | 1 | 1 |
| Phenol | C ₆ H ₆ O | 100 | 2 | 4 | 4 | 4 | 1 | 3 | 4 | 3 | 1 | 3 | 1 | 3 | 1 | 3 | 1 | 1 |
| Phosphoric acid | H ₃ PO ₄ | 20 | 1 | 4 | 2 | 4 | 1 | - | - | - | 1 | 2 | 1 | 2 | 1 | 2 | 4 | 4 |
| Phosphorus pentachloride | PCl ₅ | 100 | - | 4 | 4 | 4 | 1 | - | 4 | 4 | 1 | - | 1 | 1 | - | 1 | 1 | 1 |
| Potassium hydrogen carbonate | CHKO ₃ | saturated | 1 | 1 | 2 | 1 | 1 | - | - | - | 1 | - | 1 | 1 | 1 | - | 4 | 4 |
| Potassium hydroxide | KOH | 30 | 1 | 1 | 4 | 3 | 1 | 1 | 1 | 1 | 1 | 1 | 1 | 1 | 1 | 1 | - | 4 |
| Potassium hydroxide | KOH | 50 | 1 | 1 | 4 | 3 | 1 | 1 | 1 | 1 | 1 | 1 | 1 | 1 | 1 | 1 | - | 4 |
| Potassium nitrate | KNO ₃ | 10 | 1 | 1 | 1 | 1 | 1 | - | - | - | 1 | 1 | 1 | 1 | 1 | 1 | 1 | 1 |
| Potassium permanganate | KMnO ₄ | 100 | 1 | 4 | 1 | 1 | 1 | - | 1 | - | 1 | 3 | 1 | 1 | 1 | 3 | 1 | 1 |
| Pyridine | C ₅ H ₅ N | 100 | 1 | 1 | 4 | 1 | 3 | 4 | 4 | 4 | 1 | 4 | 1 | 4 | 1 | 4 | 1 | 1 |
| Resorcinol | C ₆ H ₆ O ₂ | 5 | 1 | 4 | 2 | 3 | 1 | 4 | 2 | - | 1 | - | 1 | - | 1 | - | 2 | 2 |
| Silver nitrate | AgNO ₃ | 100 | 1 | 1 | 1 | 1 | 1 | 1 | 1 | 1 | 1 | 1 | 1 | 1 | 1 | 2 | 4 | 4 |

11 Appendix

| - no data 1 resistant 2 practically resistant 3 partially resistant 4 not resistant | | Concentration | High Density Polyethylene | Polyamide | Polycarbonate | Polyoxymethylene | Polypropylene | Polysulfone | Polyvinyl chloride, hard | Polyvinyl chloride, weak | Polytetrafluorethylene | Acrylonitrile-butadiene-caoutchouc | Aluminium | |
|---|-----------------------|---|---------------------------|-----------|---------------|------------------|---------------|-------------|--------------------------|--------------------------|------------------------|------------------------------------|-----------|------|
| | | | Medium | Formula | [%] | HDPE | PA | PC | POM | PP | PSU | PVC | PVC | PTFE |
| | Sodium bisulphite | NaHSO ₃ | 10 | 1 | 1 | 2 | 4 | 1 | - | - | - | 1 | 1 | 1 |
| | Sodium carbonate | Na ₂ CO ₃ | 10 | 1 | 1 | 1 | 1 | 1 | - | - | - | 1 | - | 3 |
| | Sodium chloride | NaCl | 30 | 1 | 1 | 1 | 1 | 1 | 1 | 1 | 1 | 1 | 1 | 3 |
| | Sodium hydroxide | NaOH | 30 | 1 | 1 | 4 | 1 | 1 | 1 | 1 | 1 | 1 | 2 | 4 |
| | Sodium hydroxide | NaOH | 50 | 1 | 1 | 4 | 1 | 1 | 1 | 1 | - | 1 | 2 | 4 |
| | Sodium sulfate | Na ₂ SO ₄ | 10 | 1 | 1 | 1 | 1 | 1 | 1 | 1 | 1 | 1 | 1 | 1 |
| | Spirits | C ₂ H ₆ O | 96 | 1 | 1 | 1 | 1 | 1 | 1 | 1 | 3 | 1 | - | 1 |
| | Styrene | C ₈ H ₈ | 100 | 4 | 1 | 4 | 1 | 3 | - | 4 | 4 | 1 | 4 | 1 |
| | Sulphuric acid | H ₂ SO ₄ | 6 | 1 | 4 | 1 | 4 | 1 | 1 | 1 | - | 1 | 2 | 3 |
| | Sulphuric acid | H ₂ SO ₄ | fuming | 4 | 4 | 4 | 4 | 4 | 4 | 4 | 4 | 1 | 4 | 3 |
| | Tallow | — | 100 | 1 | 1 | 1 | 1 | 1 | - | 1 | 1 | 1 | 1 | 1 |
| | Tetrahydrofuran (THF) | C ₄ H ₈ O | 100 | 3 | 1 | 4 | 1 | 3 | 4 | 4 | 4 | 1 | 3 | 1 |
| | Tetrahydronaphthalene | C ₁₀ H ₁₂ | 100 | 3 | 1 | 4 | 1 | 4 | 4 | 4 | 4 | 1 | - | 1 |
| | Thionyl chloride | Cl ₂ SO | 100 | 4 | 4 | 4 | 2 | 4 | 4 | 4 | 4 | 1 | - | 3 |
| | Tin chloride | SnCl ₂ | 10 | 1 | 4 | 2 | 2 | 1 | - | - | - | 1 | 1 | 4 |
| | Transformer oil | — | 100 | 1 | 1 | 3 | 3 | 1 | 1 | 1 | - | 1 | 1 | 1 |
| | Trichloroethane | C ₂ H ₃ Cl ₃ | 100 | 3 | 3 | 4 | 2 | 4 | 4 | 4 | 4 | 1 | 4 | 4 |
| | Urea | CH ₄ N ₂ O | 10 | 1 | 1 | 1 | 1 | 1 | - | - | - | 1 | 1 | 1 |
| | Urine | — | 100 | 1 | 1 | 1 | 1 | 1 | - | 1 | 1 | 1 | - | 2 |
| | Vinegar | C ₂ H ₄ O ₂ | 10 | 1 | 4 | 1 | 1 | 1 | 1 | 1 | 1 | 1 | 2 | 1 |
| | Vinegar | C ₂ H ₄ O ₂ | 90 | 1 | 4 | 4 | 4 | 1 | 3 | 1 | 4 | 1 | - | 1 |
| | Wax | — | 100 | - | 1 | 1 | | 1 | - | - | - | 1 | - | 1 |
| | Wines | — | 100 | 1 | 1 | 1 | 2 | 1 | 1 | 1 | 1 | 1 | - | 4 |
| | Xylene | C ₈ H ₁₀ | 100 | 3 | 1 | 4 | 1 | 4 | 4 | 4 | 4 | 1 | 4 | 1 |

11.6 EC declaration of conformity



EC – DECLARATION OF CONFORMITY

The product named hereinafter was developed, designed, and manufactured in compliance with the relevant, fundamental safety and health requirements of the listed EC directives and norms.

In the event of modifications that were not authorised by us or if the product is used in a manner that is not in line with the intended purpose, this declaration will be rendered void.

| | |
|----------------------|---|
| <i>Product name:</i> | Laboratory centrifuge |
| <i>Product type:</i> | Sigma 6-16S, 6-16HS |
| <i>Order number:</i> | 10390, 10391, 10392, 10393 |
| <i>Directives:</i> | 2006/42/EC Machinery Directive 2014/35/EU Low Voltage Directive 2014/30/EU EMC Directive 2011/65/EU RoHS Directive |
| <i>Normes:</i> | EN 61010-2-020:2006 EN 61000-3-2:2006, A1:2009, A2:2009 EN 61000-3-3:2013 EN 61326-1:2013 |

Sigma Laborzentrifugen GmbH

An der Unteren Söse 50
37520 Osterode
Germany

Authorised representative
for CE matters:
Eckhard Tödteberg

Osterode, 01/03/2016



General Manager

CE_6-16S_2016-03-01_en

11 Appendix

12 Index

A

| | |
|---|------------|
| Acceleration | 37 |
| Acceleration curve | 37, 46, 74 |
| Acceleration curve (changing)..... | 46 |
| Acceleration curve (creating) | 46 |
| Accessories, cleaning and care..... | 58 |
| Acid..... | 20, 57, 58 |
| Acoustic signal..... | 53 |
| Activating the help function | 47 |
| Adapters | 30, 58 |
| Adapters and stainless steel tubes..... | 71 |
| Alkaline solutions | 20, 57, 58 |
| Ambient conditions..... | 66 |
| Ambient temperature | 66 |
| Anodised coating | 58 |
| Application examples | 13 |
| ASTM standard D91/D96 | 32 |
| Autoclaving | 61 |
| Automatic lid opening function | 43 |
| Automatic program rotation..... | 51 |
| Automatic rotor identification..... | 37 |

B

| | |
|---|----|
| Blocking a function..... | 42 |
| Blood bag systems..... | 31 |
| Brake | 37 |
| Brakeless deceleration..... | 37 |
| Brakeless deceleration from set speed | 41 |
| Brief mains power failure..... | 53 |
| Bucket..... | 30 |
| Buckets, cleaning and care | 59 |
| Buzzer/signal | 45 |

C

| | |
|--|----|
| Capacity..... | 66 |
| Carrier..... | 31 |
| Carrier systems..... | 30 |
| Carriers, cleaning and care | 59 |
| CE mark in compliance with the directive 2006/42/EC | 15 |
| Centrifugation monitoring | 40 |
| Centrifugation of blood bag systems | 31 |

| | |
|--|----------------------------|
| Centrifugation of infectious, toxic, radioactive, or pathogenic substances..... | 19 |
| Centrifugation principle | 13 |
| Centrifugation with different tube sizes..... | 29 |
| Centrifugation with low capacity | 30 |
| Centrifugation with tubes for mineral oil | 32 |
| Centrifuge cannot be started..... | 53 |
| Centrifuge decelerates during operation | 53 |
| Centrifuge is inclined..... | 53 |
| Centrifuge was moved during run | 53 |
| Centrifuge, cleaning and care | 57 |
| Centrifuges | |
| - definition | 9 |
| Changes in colour | 61 |
| Changes in structure..... | 61 |
| Changing an acceleration curve..... | 46 |
| Changing the code..... | 42 |
| Changing the contrast..... | 48 |
| Chemical and biological safety..... | 19 |
| Chemical resistance of plastic..... | 58 |
| Cleaning agents..... | 60 |
| Cleaning the bores of angle rotors | 58 |
| Cleaning the centrifuge | 57 |
| Closing the lid | 18, 27 |
| Communication error | 55 |
| Condensation..... | 26 |
| Condenser dirty | 53 |
| Connected load..... | 66 |
| Contamination..... | 19, 58 |
| Continuous heat resistance..... | 60 |
| Continuous run | 36 |
| Control system..... | 33 |
| Copyright | 10 |
| Corrosion | 18, 21, 31, 57, 58, 59, 60 |
| Cost estimate..... | 63 |
| Cracking | 58 |
| Cracks | 59 |
| Creating an acceleration curve..... | 46 |
| Current consumption..... | 66 |
| Curve menu | 46 |
| Customer-provided fuses | 26 |
| Cycles | 27, 44 |

Index

D

| | |
|---|------------|
| Damage of the surface..... | 59 |
| Dangerous goods..... | 20 |
| Dangerous materials..... | 60 |
| Deactivating the help function..... | 47 |
| Deceleration (brake)..... | 37 |
| Deceleration curve..... | 37, 46, 74 |
| Declaration of conformity..... | 10, 81 |
| Declaration of decontamination..... | 63 |
| Declaration of Decontamination..... | 65 |
| Decontamination agent..... | 58, 60 |
| Deformation of tubes..... | 61 |
| Deleting a program..... | 50 |
| Density..... | 20, 40 |
| Dialog box..... | 22 |
| Different service life of rotors and accessories | 21, 76 |
| Dimensions..... | 24 |
| Direct hazard to the life and health..... | 16 |
| Directive 2002/96/EC..... | 65 |
| Disinfectants..... | 60 |
| Disinfection of the rotor chamber and accessories..... | 60 |
| Display..... | 33, 44 |
| Display deceleration time..... | 43 |
| Disposal of the centrifuge..... | 65 |
| Disposal of the packaging..... | 65 |
| Documentation..... | 10 |
| Drive problem..... | 53 |

E

| | |
|---|--------|
| Earth conductor check..... | 22 |
| EC declaration of conformity..... | 10, 81 |
| EEPROM error..... | 55 |
| Electrical connection..... | 66 |
| Electrical safety..... | 18 |
| Emergency lid release..... | 54 |
| Equipotential bonding screw..... | 22 |
| Error correction..... | 53 |
| Error message..... | 53 |
| Executing a program..... | 50 |
| Explanation of the symbols and notes..... | 16 |
| Explosive substances..... | 19 |
| External signal..... | 45 |

F

| | |
|---|----|
| Fire preventions..... | 19 |
| Form for the return of defective parts..... | 63 |
| Function..... | 43 |
| Functional and operating elements..... | 11 |
| Fuses have tripped..... | 53 |

G

| | |
|------------------------------------|------------|
| General conditions..... | 9 |
| Glass breakage..... | 60 |
| Glass particles..... | 60 |
| Gravitational field..... | 66 |
| Grease for load bearing bolts..... | 10, 57, 59 |

H

| | |
|---|-----------|
| Hard running noise during the centrifugation | 53 |
| Hazard warnings..... | 9, 28, 31 |
| Help function..... | 47 |
| Hexagon socket wrench..... | 10 |
| Highly corrosive substances..... | 18 |

I

| | |
|---|----------------|
| Imbalance..... | 29, 30, 31, 59 |
| Imbalance error..... | 55 |
| Imbalance monitoring system..... | 22 |
| Importance of the operating manual..... | 9 |
| Important information..... | 16 |
| Improper loading..... | 53 |
| Infectious substances..... | 60 |
| Inflammable substances..... | 19 |
| Informal safety instructions..... | 17 |
| Initial start-up..... | 27 |
| Input fuse..... | 66 |
| Inspection by the manufacturer..... | 62 |
| Installation of accessories..... | 29 |
| Installation of angle rotors with a hermetically sealed lid..... | 28 |
| Installation of rotors and accessories..... | 27 |
| Installation of the rotor..... | 27 |
| Installation site..... | 26 |
| Intended use..... | 9 |
| Interrupting a centrifugation run..... | 34 |
| Interrupting a deceleration process..... | 34 |
| Invert..... | 44 |
| IP code..... | 66 |

| | | | |
|--|------------|---|------------|
| K | | Noise level | 66 |
| kin. energy | 66 | Non-greased bolts..... | 59 |
| L | | Notes on safety and hazards | 9 |
| Language..... | 44 | Notes on transport | 24 |
| Layout of the centrifuge..... | 11 | O | |
| Leaks | 31, 61 | Online download of forms | 64 |
| Lid cannot be opened | 53 | Open lid after run | 43 |
| Lid error | 55 | Opening the lid..... | 27 |
| Lid lock device | 22 | Operating personnel | 17 |
| Lid lock has not released | 53 | Operating voltage..... | 26 |
| Lid seal sticks | 53 | Operational safety..... | 58 |
| Linear curves | 74 | Option for the input and output of data | 45 |
| Load bearing bolts, cleaning and care..... | 59 | Options for data input and output..... | 52 |
| Loading a process..... | 39 | Overseas shipping | 24 |
| Loading a program..... | 49 | P | |
| Lock..... | 42 | Packaging | 25 |
| M | | Parameter error | 55 |
| Mains power switch off..... | 53 | Parameters menu | 40 |
| Mains switch | 11 | Pathogenic substances..... | 19, 57, 60 |
| Mains voltage..... | 18 | Plastic accessories, cleaning and care..... | 58 |
| Maintenance | 57 | Potential hazard to the life and health | 16 |
| Malfunctions and error correction..... | 53 | Potentially hazardous situation..... | 16 |
| Manual mode | 34 | Power consumption | 66 |
| Manufacturer..... | 66 | Power cord is not plugged in..... | 53 |
| Marking of the unit | 15 | Power supply | 26 |
| Maximum speed for tubes..... | 72 | Pressure marks..... | 59 |
| Measures in the event of hazards and accidents..... | 23 | Prevention of accidents..... | 9 |
| Mechanical safety | 18 | Problem description | 63 |
| Menu Curve | 46 | Process..... | 40 |
| Menu Help | 47 | Process error | 55 |
| Menu Parameters | 40 | Process library | 39 |
| Menu Processlibrary | 39 | Program list..... | 38, 49, 50 |
| Menu Setup | 43 | Program mode | 48 |
| Menu Standard | 35 | Program rotation | 43 |
| Mode of operation..... | 13 | Progress indicator..... | 38 |
| Modification mode active..... | 34 | Protection class | 26, 66 |
| Motor error | 55 | Q | |
| Motor shaft..... | 27, 28, 57 | Quadratic curves..... | 74 |
| Multiple carrier | 31 | Quick stop..... | 34 |
| N | | R | |
| Name plate | 11, 12 | Radioactive substances | 19, 57 |
| No indication on the display | 53 | Radius | 14, 40 |
| No power in the mains supply | 53 | Range of accessories | 68 |

Index

| | | | |
|---|------------|--|------------|
| RCF | 35 | Set-up and connection | 26 |
| Relative centrifugal force (RCF) | 14, 35 | Setup menu | 43 |
| Removal of the transport safety device | 25 | Short run | 36 |
| Remove glass particles and metal dust from the rotor chamber | 60 | Slushing oil | 10 |
| Responsibility of the operator | 17 | Solvents | 20, 57, 58 |
| Return of centrifuges, spare parts, or accessories | 63 | Sound signal | 22 |
| Return of defective parts | 63 | Sound signal (warning) | 45 |
| Risk of electrical shock | 18 | Spare part enquiries | 56 |
| Rotor chamber | 57 | Speed | 14, 35, 66 |
| Rotor identification, automatic | 37 | Speed/RCF fine | 44 |
| Rotor monitoring system | 22 | Speed-gravitational-field-diagram | 73 |
| Rotor radii | 72 | Speedometer error | 55 |
| Rotor selection list | 36 | Spin-out from set speed | 41 |
| Rotor tie-down screw | 27, 28, 59 | Standard menu | 35 |
| Rotor wrench | 10, 27, 28 | Standards and regulations | 10 |
| Rotors and accessories with a different service life | 21, 76 | Standstill monitoring system | 22 |
| Rotors for microtiter plate formats | 28 | Start delay | 43 |
| Rotors, cleaning and care | 59 | Starting a centrifugation run | 34 |
| Runtime | 35 | Starting a process | 39 |
| Runtime as of set speed | 43 | Sterilisation of the rotor chamber and accessories | 60 |
| S | | Storage and transport | 24 |
| Safety area | 20 | Storage conditions | 24 |
| Safety devices | 22 | Storage locations | 66 |
| Safety distance | 18, 20, 26 | Stress-corrosion | |
| Safety instructions | 9, 28, 31 | see | |
| Safety instructions for centrifugation | 20 | corrosion | 59 |
| Safety, chemical and biological | 19 | Structural changes | 19 |
| Safety, electrical | 18 | Supply voltage | 26 |
| Safety, mechanical | 18 | Supporting rings | 72 |
| Safety-conscious work | 17 | Switching the centrifuge off | 52 |
| Saving a program | 49 | Switching the centrifuge on | 27 |
| Scope of supply | 10 | System | 44 |
| Screws of the transport safety device are not removed | 53 | System check | 22 |
| Selection, display, and modification of data | 34 | System error | 53, 55 |
| Serial number | 12, 56, 62 | T | |
| Service | 62 | Table of error codes | 55 |
| Service contact | 56 | Table of rotors and accessories with a different service life | 21, 76 |
| Service life | 57 | Technical data | 66 |
| Service life of rotors and accessories | 21, 76 | Technical documentation | 67 |
| Service life of the accessories | 61 | Temperature error | 55 |
| Service work | 62 | Temperature value not reached | 53 |
| | | Thermal stress | 57 |
| | | Time fine | 44 |

| | | | |
|--|------------|---------------------------------------|--------|
| Time range..... | 66 | UV radiation..... | 26, 57 |
| Toxic substances | 19, 57 | V | |
| Transport safety device..... | 25 | Vents | 26 |
| Tubes..... | 31 | Vessels | 31 |
| Type of connection..... | 26 | W | |
| Type of the centrifuge | 56, 62, 66 | Warning signal | 45 |
| U | | Warranty and liability..... | 9 |
| Unblocking a function..... | 42 | Wear | 62 |
| Ungreased load- bearing bolts | 53 | Weight | 24 |
| Units of protection class I | 26 | Work on the power supply system | 18 |
| Useful volume | | Y | |
| - volume that is stated for the tube.... | 31, 72 | Year of manufacture | 12 |
| User interface | 33 | | |