



Sigma 2-16P

from serial no. 120756



Laboratory Centrifuge

Operating Manual

Please retain for later use!



In case of inquiries, please state the following numbers:

Order number:

Serial number:

© Copyright by
Sigma Laborzentrifugen GmbH
An der Unteren Söse 50
37520 Osterode am Harz
Germany

Tel.: +49 (0) 5522 / 5007-0
Fax: +49 (0) 5522 / 5007-12
Web: www.sigma-zentrifugen.de
E-mail: info@sigma-zentrifugen.de



Table of contents

1	General information	9
1.1	Importance of the operating manual.....	9
1.2	Intended use.....	9
1.3	Warranty and liability.....	9
1.4	Copyright.....	10
1.5	Standards and regulations.....	10
1.6	Scope of supply.....	10
2	Layout and mode of operation	11
2.1	Layout of the centrifuge.....	11
2.1.1	Functional and operating elements.....	11
2.1.2	Name plate.....	12
2.2	Mode of operation.....	13
2.2.1	Centrifugation principle.....	13
2.2.2	Area of application.....	13
2.2.2.1	Speed, radius, and relative centrifugal force.....	14
2.2.2.2	Density.....	14
3	Safety	15
3.1	Marking of the unit.....	15
3.2	Explanation of the symbols and notes.....	16
3.3	Responsibility of the operator.....	17
3.4	Operating personnel.....	17
3.5	Informal safety instructions.....	17
3.6	Safety instructions.....	18
3.6.1	Electrical safety.....	18
3.6.2	Mechanical safety.....	18
3.6.3	Fire prevention.....	19
3.6.4	Chemical and biological safety.....	19
3.6.5	Safety instructions for centrifugation.....	20
3.6.6	Resistance of plastics.....	20
3.6.7	Service life of rotors and accessories.....	21
3.7	Safety devices.....	22
3.7.1	Lid lock device.....	22
3.7.2	Standstill monitoring system.....	22
3.7.3	System check.....	22
3.7.4	Earth conductor check.....	22
3.7.5	Imbalance monitoring system.....	22
3.8	Measures in the event of hazards and accidents.....	23
3.9	Remaining hazards.....	23

Table of contents

4	Storage and transport	24
4.1	Dimensions and weight.....	24
4.2	Storage conditions	24
4.3	Notes on transport	24
4.4	Packaging.....	25
4.5	Transport safety device.....	25
5	Set-up and connection	26
5.1	Installation site	26
5.2	Power supply	26
5.2.1	Type of connection	26
5.2.2	Customer-provided fuses.....	26
6	Using the centrifuge	27
6.1	Initial start-up	27
6.2	Switching the centrifuge on	27
6.2.1	Opening and closing the lid.....	27
6.2.2	Installation of rotors and accessories.....	28
6.2.2.1	Installation of the rotor.....	28
6.2.2.2	Installation of angle rotors with a hermetically sealed lid	29
6.2.2.3	Installation of the microhaematocrit rotor.....	29
6.2.2.4	Installation of accessories	30
6.2.2.5	Adapters	31
6.2.2.6	Tubes.....	31
6.3	Control system "Spincontrol Universal"	32
6.3.1	User interface	32
6.3.2	Manual mode.....	33
6.3.2.1	Starting a centrifugation run	33
6.3.2.2	Interrupting a centrifugation run	33
6.3.2.3	Interrupting a deceleration process	33
6.3.2.4	Selection, display, and modification of data.....	33
6.3.2.5	Runtime	33
6.3.2.6	Speed	35
6.3.2.7	Relative centrifugal force (RCF)	35
6.3.2.8	Rotor selection	36
6.3.2.9	Softstart and softstop function.....	36
6.3.2.10	Automatic lid opening function ("Auto-Lid-Open").....	37
6.3.2.11	Sound signal ("Buzzer")	37
6.3.2.12	Input lock	37
6.3.3	Programs.....	38
6.3.3.1	Saving the current settings.....	38
6.3.3.2	Calling up stored programs	38
6.4	Switching the centrifuge off	38

Table of contents

7	Malfunctions and error correction	39
7.1	General malfunctions.....	39
7.1.1	Emergency lid release.....	40
7.2	Table of error codes.....	41
7.3	Service contact.....	42
8	Maintenance and service	43
8.1	Maintenance.....	43
8.1.1	Centrifuge.....	43
8.1.2	Accessories.....	44
8.1.2.1	Plastic accessories.....	44
8.1.3	Rotors, buckets and carriers.....	45
8.1.4	Microhaematocrit rotor.....	45
8.1.5	Load bearing bolts.....	45
8.1.6	Glass breakage.....	46
8.2	Sterilisation and disinfection of the rotor chamber and accessories.....	46
8.2.1	Autoclaving.....	47
8.3	Service.....	48
8.4	Return of defective parts.....	49
9	Disposal	51
9.1	Disposal of the centrifuge.....	51
9.2	Disposal of the packaging.....	51
10	Technical data	52
10.1	Ambient conditions.....	52
10.2	Technical documentation.....	53
11	Appendix	54
11.1	Range of accessories.....	54
11.1.1	Maximum speed for tubes.....	56
11.1.2	Rotor radii.....	57
11.2	Speed-gravitational-field-diagram.....	58
11.3	Table of the service life of rotors and accessories.....	59
11.4	Resistance data.....	60
11.5	EC declaration of conformity.....	65
12	Index	67

Table of contents

1 General information

1.1 Importance of the operating manual

A fundamental requirement for the safe and trouble-free operation of the centrifuge is to be familiar with the fundamental safety instructions and all possible hazards.

The operating manual includes important information concerning the safe operation of the centrifuge.

This operating manual and, in particular, the notes on safety and hazards must be observed by all persons operating the centrifuge.

In addition, the local rules and regulations for the prevention of accidents must be complied with.

1.2 Intended use

Centrifuges are power-driven machines that separate liquids from solid matter, liquid mixtures, or solid mixtures by centrifugal force. They are solely intended for this purpose. Any other use beyond this area of application is regarded as improper use. Sigma Laborzentrifugen GmbH cannot be held liable for any damage resulting from such improper use.

The intended use also includes

- observation of all the notes and instructions included in the operating manual and
- compliance with the care, cleaning, and maintenance instructions.

1.3 Warranty and liability

The warranty and liability are subject to our "General Conditions" that were distributed to the operator upon the conclusion of the contract.

Warranty and liability claims are excluded if they are due to:

- improper use.
- non-compliance with the safety instructions and hazard warnings in the operating manual.
- improper installation, start-up, operation, or maintenance of the centrifuge.

1 General information

1.4 Copyright

The copyright concerning the operating manual remains with Sigma Laborzentrifugen GmbH.

The operating manual is solely intended for the operator and their personnel. It includes instructions and information that must not be

- duplicated,
- distributed, or
- communicated in any other way.

Non-compliance may be prosecuted under criminal law.

1.5 Standards and regulations

EC declaration of conformity

(see chapter 11.5 - "EC declaration of conformity")

1.6 Scope of supply

The centrifuge comprises:

- | | |
|---|--|
| • 1 rotor wrench | Part no. 930 100 |
| • 1 tube of grease for load bearing bolts | Part no. 70 284 |
| • 1 connection cable | depending on the voltage variant |
| • Spare fuses | Part no. 70 102 for 220-240 V
Port no. 70 106 for 120 V |

Documentation

Operating manual incl. EC declaration of conformity
(see chapter 11.5 - "EC declaration of conformity")

Accessories

According to your order, our order confirmation, and your delivery note.

2 Layout and mode of operation

2.1 Layout of the centrifuge

2.1.1 Functional and operating elements

- 1 Lid
- 2 User interface (see chapter 6.3.1 - "User interface")
- 3 Mains switch



Fig. 1: Total view of the centrifuge

- 4 Name plate (see chapter 2.1.2 - "Name plate")
- 5 Equipotential bonding screw
- 6 Mains power input



Fig. 2: Rear view of the centrifuge

2 Layout and mode of operation

2.1.2 Name plate

- 1 Manufacturer and registered office
- 2 Type
- 3 Serial number
- 4 Max. speed
- 5 Max. kinetic energy
- 6 Max. density
- 7 Nominal voltage
- 8 Input fuse
- 9 Symbol for special disposal (see chapter 9 - "Disposal")
- 10 CE mark in compliance with the directive 2006/42/EC
- 11 Part number
- 12 Year of manufacture
- 13 Power consumption



Fig. 3: Example of a name plate

2.2 Mode of operation

2.2.1 Centrifugation principle

Centrifugation is a process for the separation of heterogeneous mixtures of substances (suspensions, emulsions, or gas mixtures) into their components. The mixture of substances, which rotates on a circular path, is subject to centripetal acceleration that is several times greater than the gravitational acceleration.

Centrifuges use the mass inertia inside the rotor chamber for separating the substances. Due to their higher inertia, particles or media with a higher density travel outwards. In doing so, they displace the components with a lower density, which in turn travel towards the centre.

The centripetal acceleration of an object inside a centrifuge, as the effect of centripetal force, depends on the distance between the object and the axis of rotation as well as on the angular velocity. It increases linearly as a function of the distance with regard to the axis of rotation and quadratically as a function of the angular velocity. The bigger the radius in the rotor chamber is and the higher the speed is, the higher the centripetal acceleration is. However, the forces acting on the rotor also increase.

2.2.2 Area of application

Depending on the area of application of the centrifuge and also on the particle size, solids content, and volume throughput of the mixture of substances that is to be centrifuged, there are different types of centrifuges. The areas of application go from household use as a salad spinner or honey separator up to specialised technical applications in the clinical, biological, or biochemical context:

- For numerous clinical examinations, cellular material must be separated from the liquid to be analysed. The normal separation process can be sped up considerably by using laboratory centrifuges.
- In the metal-working industry, centrifuges are used for separating oil from metal cuttings. Dairies use centrifuges in order to separate cow's milk into cream and low-fat milk.
- Particularly big centrifuges are used in the sugar industry for separating the syrup from the crystalline sugar.
- Ultracentrifuges are predominantly used in biology and biochemistry in order to isolate particles, e.g. viruses. They are specifically designed for high speeds up to 500,000 rpm. The rotor moves in a vacuum in order to avoid air friction.

2 Layout and mode of operation

2.2.2.1 Speed, radius, and relative centrifugal force

The acceleration g , which the samples are subject to, can be increased by increasing the radius in the rotor chamber and by increasing the speed. These three parameters are interdependent and linked with each other via the following formula:

$$\text{Relative centrifugal force RCF} = 11.18 \times 10^{-6} \times r \times n^2$$

r = radius in cm

n = speed in rpm

RCF without any dimension

If two values are entered, the third value is determined by way of the stated formula. If, afterwards, the speed or the radius is changed, the resulting relative centrifugal force will be recalculated automatically by the control unit. If the RCF is changed, the speed will be adapted while the specified radius is maintained.

The speed-gravitational-field-diagram provides an overview of the relationship between speed, radius, and RCF (see chapter 11.2 - "Speed-gravitational-field-diagram").

2.2.2.2 Density

The laboratory centrifuge is suitable for the separation of constituents of different densities in mixtures with a maximum density of 1.2 g/cm^3 . All information concerning the speed of rotors and accessories refers to liquids with a density corresponding to this specification. If the density is above this value, the maximum permissible speed of the centrifuge must be reduced based on the following formula:

















$$n = n_{\max} \times \sqrt{(1,2 / \text{Rho})}$$

Rho = density in g/cm^3

3 Safety

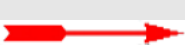
3.1 Marking of the unit

The following symbols are used for all types of centrifuges manufactured by Sigma:

	Dangerous voltage		On (Power)
	Hot surface		Off (Power)
	Caution! Risk of bruising		Name plate (see chapter 2.1.2 - "Name plate")
	Protective earth (ground)		CE mark in compliance with the directive 2006/42/EC
	Earth (ground)		Do not dispose as part of domestic waste
	Unplug the mains plug		GS mark (tested safety; only for Germany)
	Arrow indicating the direction of rotation		NRTL mark (only for the USA and Canada)
	4°C Guarantee		RCM mark (only for Australia)
	Centrifuge with heating system		

i
NOTE

Safety indications on the centrifuge must be kept readable at all times. If necessary, they must be replaced.

i
NOTE

Not all of the symbols/labels are used for this centrifuge type.

3 Safety

3.2 Explanation of the symbols and notes

In this operating manual, the following names and symbols to indicate hazards are used:



This symbol stands for a **direct** hazard to the life and health of persons.

Non-observance of these symbols **causes** serious health problems up to life-endangering injuries.



This symbol stands for a **direct** hazard to the life and health of persons due to electrical voltage.

Non-observance of these symbols **causes** serious health problems up to life-endangering injuries.



This symbol stands for a **potential** hazard to the life and health of persons.

Non-observance of these symbols **can** cause serious health problems up to life-endangering injuries.



This symbol indicates a potentially hazardous situation

Non-observance of these notes can cause minor injuries or damage to property.



This symbol indicates important information.

3.3 Responsibility of the operator

The operator is responsible for authorising only qualified personnel to work on the centrifuge (see chapter 3.4 - "Operating personnel").

The areas of responsibility of the personnel concerning the operation, maintenance, and care of the unit must be clearly defined.

The safety-conscious work of the personnel in compliance with the operating manual and the relevant EC and national health and safety regulations as well as with the accident prevention regulations must be checked at regular intervals (e.g. every month).

Under the international rules for health and safety at work, the operator is obliged to:

- take measures in order to prevent all danger to life or health during work.
- ensure that centrifuges are operated properly and entirely as intended (see chapter 1.2 - "Intended use").
- take protective measures against fire and explosion when working with hazardous substances.
- take measures for the safe opening of centrifuges.

3.4 Operating personnel

Persons operating the unit must

- be familiar with the fundamental regulations concerning workplace safety and accident prevention
- have read and understood this operating manual (and in particular the safety sections and warning notes) and confirmed this with their signature.

3.5 Informal safety instructions

- This operating manual is a part of the product.
- The operating manual must be kept at the location of use of the centrifuge. Ensure that it is accessible at all times.
- The operating manual must be handed over to any subsequent owner or operator of the centrifuge.
- Any changes made must be added to the operating manual.
- In addition to the operating manual, the general and local rules and regulations concerning the prevention of accidents and the protection of the environment must also be supplied.
- Safety and danger indications on the centrifuge must be kept readable at all times. If necessary, they must be replaced.

3 Safety

3.6 Safety instructions

3.6.1 Electrical safety

To reduce the risk of electrical shock, the centrifuge uses a three-wire electrical cord and plug to connect the equipment to earth-ground. To preserve this safety feature:



DANGER

- Ensure that the wall socket is properly wired and grounded.
- Check that the mains voltage agrees with the nominal voltage listed on the name plate.
- Do not place vessels containing liquid on the centrifuge lid or within the safety distance of 30 cm around the centrifuge. Spilled liquids may get into the centrifuge and damage electrical or mechanical components.
- Work on the power supply system must only be performed by certified electricians.
- Inspect the electrical equipment of the unit regularly. Defects such as loose or burnt cables must be eliminated immediately.

3.6.2 Mechanical safety

In order to ensure the safe operation of the centrifuge, observe the following:



WARNING

- Do not open the lid when the rotor is in motion!
- Do not reach into the rotor chamber when the rotor is in motion!
- Do not use the centrifuge if it was installed incorrectly.
- Do not use the centrifuge without panels.
- Do not use the centrifuge if the rotors and inserts show signs of corrosion or other defects.
- Only use the centrifuge with rotors and accessories that have been approved by the manufacturer. In case of doubt, contact the manufacturer (see chapter 7.3 - "Service contact").
- Do not hold your fingers between the lid and the housing when closing the lid. Risk of crushing!
- Defective lid relieving devices could cause the centrifuge lid to fall (contact the service department, if necessary). Risk of crushing!
- Do not hit or move the centrifuge during its operation.
- Do not lean against or rest on the centrifuge during its operation.
- Do not spin any substances that could damage the material of the rotors and buckets of the centrifuge in any way. Highly corrosive substances, for example, damage the material and affect the mechanical strength of the rotors and buckets.
- Stop the centrifuge immediately in the event of a malfunction. Eliminate the malfunction (see chapter 7 - "Malfunctions and error correction") or inform the service department of the manufacturer (see chapter 7.3 - "Service contact").
- Ensure that all repairs are performed only by authorised and specialised personnel.

WARNING

- Prior to any start-up, check the centrifuge, rotor, and accessories for signs of damage that can be discerned from the outside. Special attention must be paid to all of the rubber parts (e.g. motor cover, lid seal, and adapters) in terms of visible structural changes. Defective parts must be replaced immediately.
- Open the centrifuge when it is not in use so that moisture can evaporate.

3.6.3 Fire prevention

DANGER

- Do not spin explosive or inflammable substances.
- Do not use the centrifuge within hazardous locations.

3.6.4 Chemical and biological safety

If pathogenic, toxic, or radioactive samples are intended to be used in the centrifuge, it is in the responsibility of the user to ensure that all necessary safety regulations, guidelines, precautions, and practices are adhered to accordingly.

DANGER

- Infectious, toxic, pathogenic, and radioactive substances may only be used in special, certified containment systems with a bio-seal in order to prevent the material from being released.
- Take suitable precautions for your own safety if there is a risk of toxic, radioactive, or pathogenic contamination
- Materials that chemically react with each other with a high level of energy are prohibited.

WARNING

- Keep informed about local measures to avoid harmful emissions (depending on the substances to be centrifuged).
- Protective clothing is not required for the operation of the centrifuge. The materials to be centrifuged may, however, require special safety measures (e.g. centrifugation of infectious, toxic, radioactive, or pathogenic substances).

3 Safety

3.6.5 Safety instructions for centrifugation

For safe operation, observe the following before starting the centrifuge:



WARNING

- Ensure that the centrifuge was set up properly (see chapter 5 - "Set-up and connection").
- Maintain a safety distance of at least 30 cm (12 inches) around the centrifuge.
- Do not store any dangerous goods in the centrifuge area.
- Do not stay in the safety area longer than what is absolutely necessary for the operation of the centrifuge.
- Only use the centrifuge with rotors and accessories that have been approved by the manufacturer. We explicitly warn against the use of equipment of poor quality. Breaking glass or bursting vessels can cause dangerous imbalances at high speeds
- Ensure that rotor and buckets are correctly fitted (see chapter 6.2.2.1 - "Installation of the rotor").
- Observe the instructions on the installation of accessories (see chapter 6.2.2.4 - "Installation of accessories").
- The rotor must be loaded axial symmetrically at equal weights.
- If liquids with a density $> 1.2 \text{ g/cm}^3$ are used, reduce the speed (see chapter 2.2.2.2 - "Density").
- Do not use the centrifuge if the rotor is loaded asymmetrically.
- Do not use the centrifuge with tubes that are excessively long.



WARNING

3.6.6 Resistance of plastics

Chemical influences have a strong effect on the polymeric chains of plastics, and, therefore, on their physical properties. Plastic parts can be damaged if solvents, acids, or alkaline solutions are used.



NOTE

- Refer to the resistance data (see chapter 11.4 - "Resistance data")!

3.6.7 Service life of rotors and accessories

The rotors and accessories have a limited service life.



WARNING

- Perform regular checks (at least once per month) for safety reasons!
- Pay special attention to changes, such as corrosion, cracks, material abrasion, etc.
- After 10 years, they must be inspected by the manufacturer.
- After 50,000 cycles, the rotor must be scrapped for reasons of safety.
- If other data concerning the service life are engraved on the rotor or bucket, these data shall apply accordingly. For example, a bucket with the engraving “max. cycles = 10,000” has a service life of 10,000 cycles, and a rotor with the engraving “Exp. date 02/20” must be scrapped in February 2020 at the latest (see figure).



Fig. 4: Different service life – engraving on the bucket/rotor



NOTE

- Refer to the table of rotors and accessories with a different service life (see chapter 11.3 - "Table of the service life of rotors and accessories")!

3 Safety

3.7 Safety devices

3.7.1 Lid lock device

The centrifuge can only be started when the lid is properly closed. The electrical lock must be locked. The lid can only be opened when the rotor has stopped. If the lid is opened by way of the emergency release system during operation, the centrifuge will immediately switch off and decelerate brakeless. If the lid is open, the drive is completely separated from the mains power supply, i.e. the centrifuge cannot be started (see chapter 7.1.1 - "Emergency lid release").

3.7.2 Standstill monitoring system

Opening of the centrifuge lid is only possible if the rotor is at a standstill. This standstill is checked by the microprocessor.

3.7.3 System check

An internal system check monitors the data transfer and sensor signals with regard to plausibility. Malfunctions are indicated by error messages with a number in the speed/rcf display (see chapter 7.2 - "Table of error codes").

3.7.4 Earth conductor check

For the earth conductor check, there is an equipotential bonding screw on the rear panel of the centrifuge (see chapter 2.1.1 - "Functional and operating elements"). An earth conductor check can be carried out by authorized and specialized personnel using a suitable measuring instrument. Please contact the service department (see chapter 7.3 - "Service contact").

3.7.5 Imbalance monitoring system

The indication "Imbalance" in the rotor field and, in some cases, also a sound signal indicate that the centrifuge is in the impermissible imbalance range. The drive will be switched off in the acceleration phase or during the run.

3.8 Measures in the event of hazards and accidents



DANGER

- If an emergency arises, switch off the centrifuge immediately!
- If in doubt, call the emergency doctor!

3.9 Remaining hazards

The unit was built state- of- the- art and according to the accepted safety rules. However, danger to life and limb of the operator, or of third parties, or impairments of the unit or other material assets cannot be completely excluded when the unit is being used.

- Use the unit only for the purpose that it was originally intended for (see chapter 1.2 - "Intended use").
- Use the unit only if it is in a perfect running state.
- Immediately eliminate any problems that can affect safety.

4 Storage and transport

4 Storage and transport

4.1 Dimensions and weight

	Sigma 2-16P
Height:	300 mm
Height with open lid:	610 mm
Width:	365 mm
Depth:	452 mm
Weight:	32 kg

4.2 Storage conditions

The centrifuge can be stored in its original packaging for up to a year.

- Store the centrifuge only in dry rooms.
- The permissible storage temperature is between -20°C and +60°C.
- If you would like to store it for more than one year, or if you intend to ship it overseas, please contact the manufacturer.

4.3 Notes on transport

- Install the transport safety device (see chapter 4.5 - "Transport safety device")
- Always lift the centrifuge with a lifting device or with a sufficient number of people helping you.
- When lifting the centrifuge, always reach under the centrifuge from the side.



CAUTION

The centrifuge weighs approx. 32 kg!

- For transport use suitable packaging and, if at all possible, the original packaging (see chapter 4.4 - "Packaging").

4.4 Packaging

The centrifuge is packaged in a threepart slip-lid box.

- Take off the lid.
- Remove the box containing the accessories and the packaging material.
- Remove the ring of the slip-lid box.
- Lift the centrifuge upwards with a lifting device or with a sufficient number of people to lift it safely. When lifting the centrifuge, always reach under the centrifuge from the side.



CAUTION

The centrifuge weighs approx. 32 kg!

- Retain the packaging for any possible future transport of the centrifuge.

4.5 Transport safety device

The transport safety device consists of a foamed plastic piece in the rotor chamber.



CAUTION

The transport safety device must be removed prior to start-up!

Removal

- Open the lid by pressing the lid key. If the centrifuge is not connected to the power supply, use the emergency release of the lid (see chapter 7.1.1 - "Emergency lid release").
- Unscrew the rotor tie-down screw.
- Remove the foamed plastic piece from the rotor chamber, by lifting it carefully on one side.
- Retain the transport safety device for the possibility of the return of the centrifuge.

5 Set-up and connection

5 Set-up and connection

5.1 Installation site

Operate the centrifuge only in closed and dry rooms.

All the energy supplied to the centrifuge is converted into heat and emitted to the ambient air.

- Ensure sufficient ventilation.
- Keep a safety distance of at least 30 cm around the centrifuge so that the vents in the centrifuge remain fully effective.
- Do not subject the centrifuge to thermal stress, e.g. by positioning it near heat generators.
- Avoid direct sunlight (UV radiation).
- The table must be stable and have a solid, even surface.
- Attention: During transport from cold to warmer places, condensational water will collect inside the centrifuge. It is important to allow sufficient time for drying (min. 24 h) before the centrifuge can be used again.

5.2 Power supply

5.2.1 Type of connection



DANGER

The operating voltage on the name plate must correspond to the local supply voltage!

Sigma centrifuges are units of protection class I. The centrifuges of this model series have a three-wire power cord with an IEC C13 connector.

5.2.2 Customer-provided fuses

Typically, the centrifuge must be protected with 16 Amp L or B fuses that are to be provided by the customer.

6 Using the centrifuge

6.1 Initial start-up



DANGER

- Before the initial start-up, please ensure that your centrifuge is properly set up and installed (see chapter 5 - "Set-up and connection").

6.2 Switching the centrifuge on

- Press the mains power switch.

The display then illuminates. The centrifuge is ready for operation.

6.2.1 Opening and closing the lid

The lid can be opened if the centrifuge is at a standstill and if the lid key is illuminated.

- Press the lid key in order to open the lid.

The centrifuge cannot be started if the lid is opened.

- To close, press with both hands slightly on the lid until both electrical locks are locked.



WARNING

Do not place your fingers between the lid and the housing when closing the lid. Risk of crushing!



NOTE

A flashing lid key indicates that only one lid lock has locked.

6 Using the centrifuge

6.2.2 Installation of rotors and accessories

6.2.2.1 Installation of the rotor

- Open the centrifuge lid by pressing the lid key.
- Unscrew the rotor tie-down screw from the motor shaft (counter-clockwise).
- Lower the rotor with its central bore straight down onto the motor shaft.
- Tighten the rotor tie-down screw clockwise with the supplied rotor wrench with 5 Nm. In doing so, hold the rotor at its outer rim.



WARNING

Once a day or after 20 cycles, the rotor tie-down screw must be loosened by some turns, and the rotor must be lifted and fastened again. This ensures a proper connection between the rotor and the motor shaft.



CAUTION

The lid screw serves for the fastening of the lid onto the rotor only, not for the fastening of the rotor onto the motor shaft.



CAUTION

When using rotors for microtiter plate formats:
Ensure that the plate holders are inserted together with the plates into the buckets.



NOTE

The lid screw serves for the fastening of the lid onto the rotor only, not for the fastening of the rotor onto the collet chuck.

- Prior to installing the lid, check for the tight fit (5 Nm) of the rotor tie-down screw.
- Follow the safety instructions and hazard warnings (see chapter 3 - "Safety")!

6.2.2.2 Installation of angle rotors with a hermetically sealed lid

- Screw the rotor cover onto the rotor and tighten it.
- Lower the rotor with the cover onto the motor shaft .
- Insert the rotor tie-down screw into the motor shaft. Tighten the rotor tie-down screw with 5 Nm using the supplied rotor wrench so that the spring washer assembly is compressed tightly.
- The rotor can also be used without a cover.
- The rotors can be installed or removed with a closed lid after loosening the rotor tie-down screw.
- Follow the safety instructions and hazard warnings (see chapter 3 - "Safety")!

- 1 Rotor tie down screw
 2 Lid
 3 Rotor

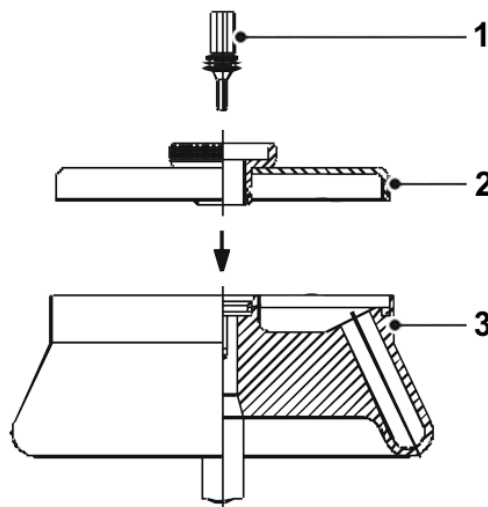

Fig. 5: Angle rotor with a hermetically sealed lid

6.2.2.3 Installation of the microhaematocrit rotor

- Open the centrifuge lid by pressing the lid key.
- Replace the rotor tie-down screw with the rotor tie-down screw of the microhaematocrit rotor (part no. 81543, included in the scope of supply of the microhaematocrit rotor), and tighten it loosely.
- Lower the rotor with its central bore straight down onto the motor shaft.
- Tighten the rotor tie-down screw clockwise with 5 Nm using the supplied rotor wrench. In doing so, hold the microhaematocrit rotor with one hand and tilt it slightly in order to prevent the motor shaft from slipping through.
- Check the rotor for a correct and tight fit.
- Follow the safety instructions and hazard warnings (see chapter 3 - "Safety")!

CAUTION

Please consider the maximum permissible gravitational field of 12,000 x g. An excess gravitational field will result in an increased risk of glass breakage!

6 Using the centrifuge

Operation

- Fill the capillary tubes with blood and seal them at one end with putty or by fusion.
- Place the capillary tubes into the recesses of the rotor with the sealed end against the rubber ring. Ensure that the capillary tubes fit tightly against the rubber ring. The opposite places must be loaded.
- Screw on the rotor cover.
- Close the centrifuge lid.
- Enter the following parameters: RCF 12,000 x g, runtime approx. 5 minutes.
- Start the centrifuge.
- Open the centrifuge lid when the rotor has stopped.
- Unlock the rotor cover and lift it off.

Evaluation

- Put the reader onto the microhaematocrit rotor.
- Turn the reader and perform a fine adjustment with the aid of the central eccentric mechanism in order to localize the O-point and the maximum liquid point in the capillary tubes. You can now read the percentage value.
- Remove the capillary tubes. Some of the tubes can also be evaluated with the reader outside of the rotor (see the instructions for use on the back of the reader).

6.2.2.4 Installation of accessories

- Only use inserts that are suitable for the rotor (see chapter 11.1 - "Range of accessories").
- All buckets of the swing-out rotor need to be installed when spinning.
- Always load the axial symmetrical inserts/buckets of the rotors with the same accessories and fill to avoid imbalance.

Centrifugation with different tube sizes

Working with different tube sizes is possible. In this case, however, it is very important that axial symmetrical inserts are identical.

correct

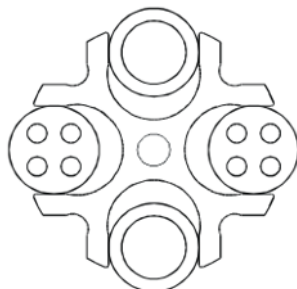

incorrect



Fig. 6: Permissible and impermissible loading of a swing-out rotor with different tube sizes (example illustrations)

6 Using the centrifuge

Centrifugation with low capacity

- Install the tubes axial symmetrically so that the buckets and their inserts are loaded evenly.
- It is not permissible to load angle rotors on only one axis.

correct

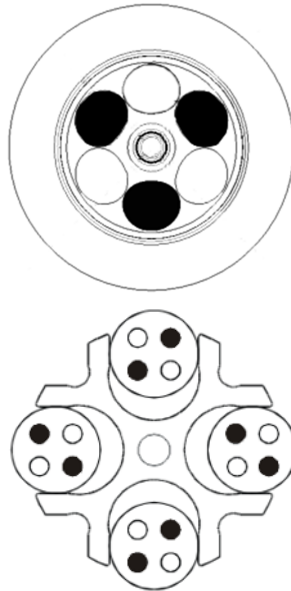

incorrect

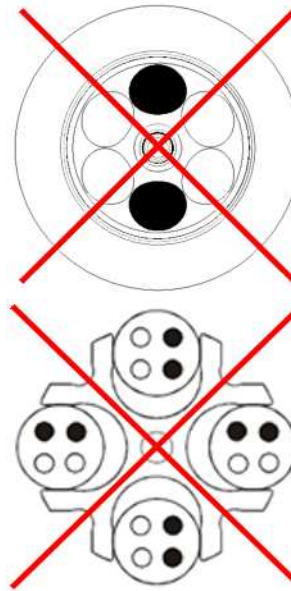

Fig. 7: Permissible and impermissible loading of an angle rotor and a swing-out rotor (example illustrations)

6.2.2.5 Adapters

In order to ensure easy handling, even if vessels of various sizes are used, carrier systems were developed.

- Load the opposite adapters with the same number of vessels and with the same weights in order to avoid imbalance.
- If all of the compartments of a carrier are not used, the buckets must be loaded evenly. Loading the edges of a bucket only is not permissible.

6.2.2.6 Tubes

- Load the tubes outside of the centrifuge. Liquids in the buckets or multiple carriers cause corrosion .
- Fill the tubes carefully and arrange them according to their weight. Imbalances result in the excessive wear of the bearings.
- In high-speed angle rotors, the vessels must be filled up to their useful volume (= the volume stated for the vessel). If the vessels are only partially filled, they will deform. This may result in leaks at the seals that may become loose.
- When using glass tubes, the maximum value of 4,000 x g must not be exceeded (except special high-strength glass tubes; please refer to the information provided by the manufacturer).
- Follow the safety instructions and hazard warnings (see chapter 3 - "Safety")!

6 Using the centrifuge

6.3 Control system "Spincontrol Universal"

6.3.1 User interface

The centrifuge is operated via three buttons with integrated light-emitting diodes and two functions knobs. The display is divided into several different fields. The various functions of the system can be called up by pressing and turning the functions knobs.

- 1 Start key
- 2 Left function knob
- 3 Display
- 4 Right function knob
- 5 Stop key
- 6 Lid key



Fig. 8: User interface of the "Spincontrol Universal" control system

Display

The centrifuge display has the following display fields:

- 1 "Lock" symbol for lockdown
- 2 Time field
- 3 Speed field
- 4 Several display fields (e.g. for rotor, deceleration curve or program selection)
- 5 RCF field

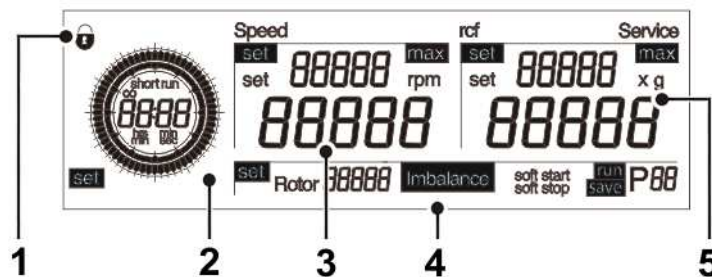

Fig. 9: Display of the "Spincontrol Universal" control system

6.3.2 Manual mode

6.3.2.1 Starting a centrifugation run

The centrifuge is ready for operation when the start key is illuminated.

- Press the start key in order to start a centrifugation run.

6.3.2.2 Interrupting a centrifugation run

- Press the stop key in order to interrupt a centrifugation run.

The centrifugation run will be terminated prematurely.

6.3.2.3 Interrupting a deceleration process

- Press the start key during a deceleration process in order to interrupt it and to restart the centrifuge.

6.3.2.4 Selection, display, and modification of data

- Turn the left function knob in order to select a field. The selected field will be preceded by the indication "set", "run", or "save".
- Press the left function knob. The indication ("set", "run", or "save") flashes and the modification mode is active.
- Turn the right function knob in order to modify the set value of the selected field.
- Press the right function knob again to confirm the input and to quit the modification mode
- If the input is not confirmed, the value will be automatically reset to the last setting.

6.3.2.5 Runtime

The runtime is displayed in the left section of the display and can be set at different intervals in a range from 10 seconds to 11 hours and 59 minutes.

The parameter runtime can be changed during the centrifugation.



If the runtime is changed during an active centrifugation run, the time that has already elapsed will not be taken into consideration. The centrifuge will perform a complete run with the new runtime.

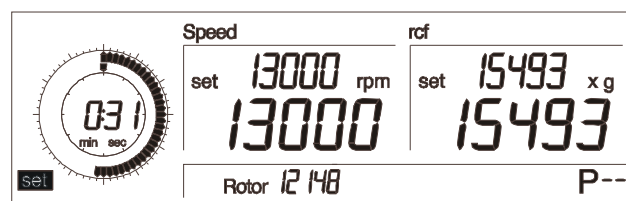

Fig. 10: Setting the runtime

6 Using the centrifuge

Continuous run

During the continuous run, the runtime of the centrifuge is unlimited and must be stopped manually. The centrifuge accelerates during the continuous run until the set speed is reached.

- Select the modification mode and turn the function knob from the time 00:10 anti-clockwise or from the time 11:59 clockwise. The indication "Cont" and the symbol " ∞ " will be displayed in the time field.

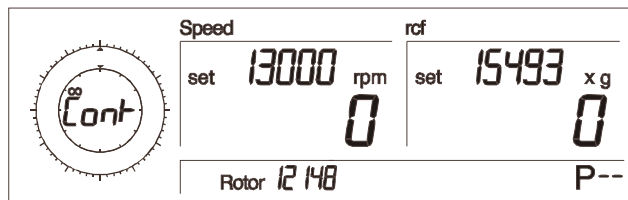

Fig. 11: Indication "Cont" during a continuous run

Short run

- Keep the start key pressed during the short run.

During the short run, the centrifuge accelerates at maximum power until the maximum speed is reached. The runtime is counted and in the time field the indication "short run" is displayed.

When the start key is released, the centrifuge decelerates at maximum power to a standstill.

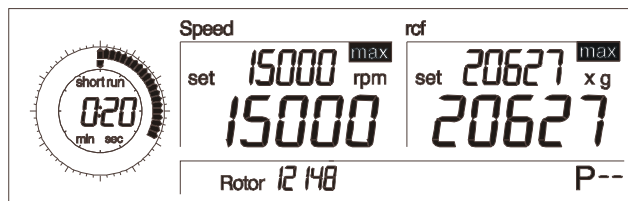

Fig. 12: Indication "short run" during a short run

Changing the time increments

By default, the runtime is changed in intervals of 10 sec (in the mode min:sec) or in intervals of 10 min (in the mode hrs:min)

To change the runtime in intervals of 1 sec or 1 min:

- Keep the stop key pressed while setting the desired runtime with the right function knob

6.3.2.6 Speed

The set speed of the centrifuge is displayed in the upper area of the speed field. The actual value is displayed right below. The speed is stated as the number of revolutions per minute (rpm). The speed/RCF values are interdependent (see chapter 2.2.2.1 - "Speed, radius, and relative centrifugal force"). The maximum speed values depend on the rotor that is used.

It is also possible to change the RCF value during a centrifugation run.

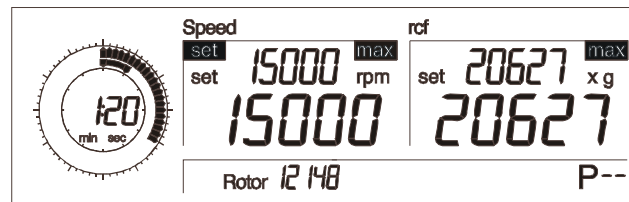

Fig. 13: Setting the speed

Changing the speed increments

By default, the speed is changed in intervals of 100 rpm.

To change the speed in intervals of 1 rpm:

- Keep the stop key pressed while setting the desired speed with the right function knob.

6.3.2.7 Relative centrifugal force (RCF)

The set RCF value of the centrifuge is displayed in the upper area of the RCF field. The actual value is displayed right below. The RCF value is stated as a multiple of the gravitational acceleration (x g). The values of speed and RCF are interdependent (see chapter 2.2.2.1 - "Speed, radius, and relative centrifugal force"). The maximum speed/RCF values depend on the rotor that is used.

The parameter RCF can be changed during the centrifugation.



Abb. 14: Setting the RCF-value

Changing the RCF increments

By default, the RCF value is changed in intervals of 10 x g.

To change the RCF value in intervals of 1 x g:

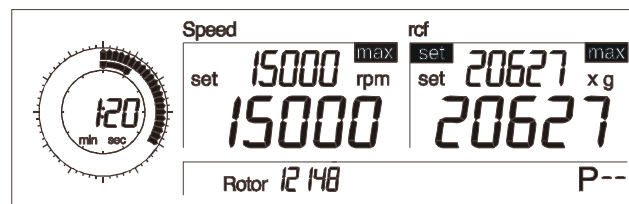
- Keep the stop key pressed while setting the desired RCF value with the right function knob.

6 Using the centrifuge

6.3.2.8 Rotor selection

This field shows the rotor that is currently being used.

The centrifuge is equipped with an automatic rotor identification system. After the installation of the rotor, the rotor ID will be displayed.

It is also possible to manually select the rotor.



NOTE

The rotor selection can only be changed when the centrifuge is at a standstill.

- Select the "Rotor" field and confirm the selection. The indication "set" flashes in the activated status.
- Turn the right function knob until the desired rotor number is selected.
- Press the right function knob to confirm the input. The selected rotor will be adopted.

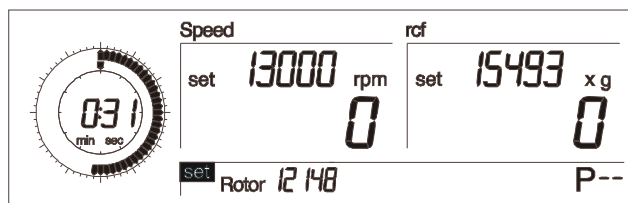

Fig. 15: Rotor selection



NOTE

Attention – special case!!!

If the rotors 12072 or 12107 are not preselected, rotor 12073 will be automatically displayed for rotor 12072, and rotor 12133 for rotor 12107.

This setting does not cause any problems for the centrifugation since the suggested rotors have the same maximum speed.

6.3.2.9 Softstart and softstop function

The softstart function is used to extend the acceleration time, whereas the softstop function is used to extend the deceleration time. The current combination is shown on the display.

- Press the stop key repeatedly until the desired combination is displayed. The possible combinations are called cyclically.
 - If "soft start" is displayed, only the softstart function is activated.
 - If "soft start" and "soft stop" are displayed, the softstart and the softstop function are activated.
 - If "soft stop" is displayed, only the softstop function is activated.
 - If "soft start" is displayed and the "soft stop" indication flashes, the softstart function and the brakeless deceleration are activated.
 - If the "soft stop" indication flashes, the brakeless deceleration is activated.
 - If no indication is displayed, the standard operating mode is restored.

6.3.2.10 Automatic lid opening function ("Auto-Lid-Open")

The automatic lid opening function must be activated so that the lid opens automatically at the end of the operation.

In order to activate the automatic lid opening function:

- Press the lid key three times and on the third time hold it down for approx. two seconds.
- Proceed in the same way in order to deactivate the function.

After every change, the current status of the setting is displayed in the form of a message running over the display ("Auto-Lid-Open on" or "off").

6.3.2.11 Sound signal ("Buzzer")

This function is used to set an acoustic signal that sounds at the end of the centrifugation run and also in the event of an imbalance or error message.

In order to activate the sound signal:

- Press the lid key five times and on the fifth time hold it down for approx. two seconds.
- Proceed in the same way in order to deactivate the function..

After every change, the current status of the setting is displayed in the form of a message running in the display ("Buzzer on" or "off").

6.3.2.12 Input lock

In order to prevent the centrifuge from being manipulated by unauthorised persons, inputs can be disabled via the menu. Inputs via the keypad, i.e. for starting or stopping a centrifugation run or for opening the lid, are enabled.

Activating a simple input lock:

- Turn the left function knob until the symbol "🔒" is displayed in the upper left corner of the display. The centrifuge can only be started and stopped, but the parameters cannot be changed.

As long as the symbol is displayed, the centrifuge can only be started and stopped, but the parameters cannot be changed.

Activating a permanent input lock:

- Press the start key three times and hold for approximately 2 seconds when pressing it for the third time.

After the activation of this function, the padlock symbol flashes. The input lock is activated.

- Proceed in the same manner in order to deactivate the permanent input lock.

The current status remains active even if the centrifuge is switched off with the help of the mains power switch.

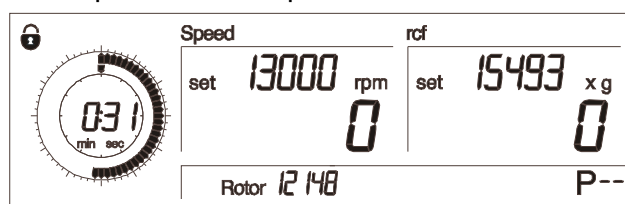

Fig. 16: "Padlock" symbol indicating an activated input lock

6 Using the centrifuge

6.3.3 Programs

A program contains all the data that are required for a centrifuge run. Certain sedimentation results can be repeated under identical conditions. A maximum of 50 programs can be stored and loaded under the numbers 1 – 50, when the centrifuge is at a standstill.

6.3.3.1 Saving the current settings

- Select the desired parameters.
- Turn the left function knob until "save" is indicated and confirm the selection by pressing the right function knob. The indication "save" flashes and the modification mode is active.
- Select the desired program number by turning the right function knob and confirm the selection by pressing the right function knob.



NOTE

Program numbers that are already occupied will be overwritten with the current data.

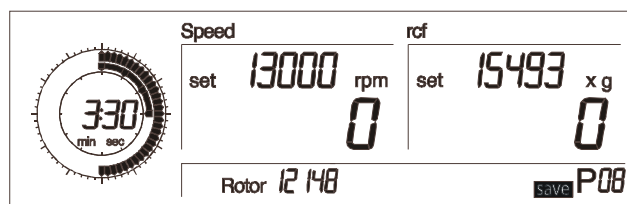

Fig. 17: Saving a program; here: program no. 08

6.3.3.2 Calling up stored programs

- Turn the left function knob until "run" is indicated and confirm the selection by pressing the right function knob. The indication "run" flashes and the modification mode is active.
- Select the desired program number by turning the right function knob and confirm the selection by pressing the right function knob.

The program is now loaded

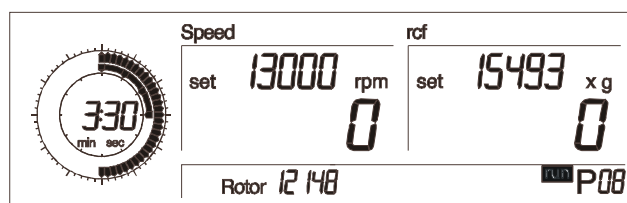

Fig. 18: Loading a program; here: program no. 8

6.4 Switching the centrifuge off

- Open the centrifuge when it is not in use so moisture can evaporate.
- Switch the centrifuge off by pressing the mains power switch.

7 Malfunctions and error correction

7.1 General malfunctions

Error messages are displayed with a code number. If the acoustic signal is activated, it sounds when the error message is displayed.

- Eliminate the source of the problem (see table below).
- Acknowledge the error messages by pressing the lid key.

NOTE

Error messages can be eliminated by pressing the lid key. The error itself will not be eliminated, but the centrifuge can be operated again.

Type of error	Possible reason	Correction
No indication on the display	No power in the mains supply	Check fuse in the mains supply
	Power cord is not plugged in	Plug in power cord correctly
	Fuses have tripped	Reactivate temperature fuse (see chapter 5.2.1 - "Type of connection")
	Mains power switch off	Switch mains power switch on
Centrifuge cannot be started: start key LED is not illuminated	Several	Power off/on. If the error occurs again, contact service
Centrifuge cannot be started: lid key LED flashes	The lid lock is not closed correctly	Open and close the lid. If the error occurs again, contact service
Centrifuge decelerates during operation	Brief mains power failure	Press start key in order to restart the centrifuge
	System error	Power off/on. If the error occurs again, contact service
Centrifuge decelerates during operation, imbalance message is displayed	<ul style="list-style-type: none"> – Improper loading – Centrifuge is inclined – Drive problem – Centrifuge was moved during run 	Balance load and restart the centrifuge. If the error occurs again, contact service(see chapter 7.1.1 - "Emergency lid release")
	– Ungreased load- bearing bolts	Clean and grease load- bearing bolts
Lid cannot be opened	Lid lock has not released	Unlock the lid manually and contact service
	Lid seal sticks	Clean the lid seal and apply talcum powder
Temperature value cannot be reached (only for refrigerated centrifuges)	Condenser dirty (only air-cooled units)	Clean the condenser. If the error occurs again, contact service

7 Malfunctions and error correction

7.1.1 Emergency lid release

In the event of a power failure, it is possible to manually open the centrifuge lid using two stoppers that are secured with screws. They are located on the front of the bottom panel (see figure).

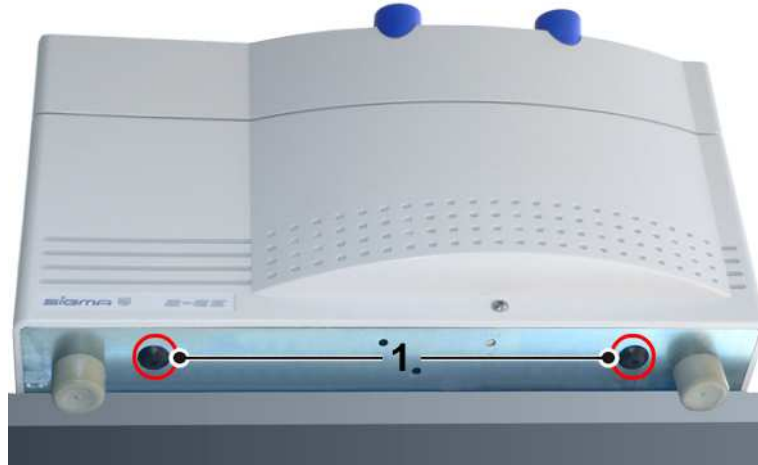

Fig. 19 : Position of the opening for the emergency release

- Switch off the mains power switch and disconnect the power cord from the socket
- Unscrew the screws in the stoppers.
- Remove the stoppers (see figure below, item 2) on the front of the button, e.g. with a screwdriver.

- 1 String
- 2 Stopper
- 3 Screw

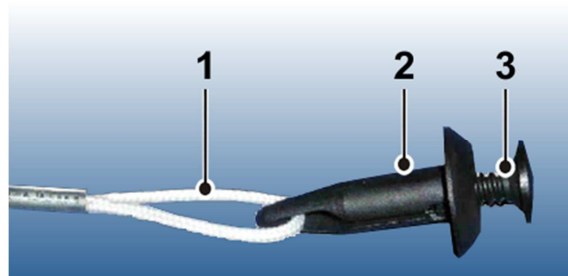

Fig. 20: Screw for the emergency lid release

- The stoppers are connected with a string. Pull the string in order to release the lid.
- Then, reinsert the stoppers into the openings.



WARNING

Do not unlock or open the lid unless the rotor is at a standstill.

If the lid is opened via the emergency lid release system during a centrifuge run, the centrifuge will be switched off immediately and decelerate in an unbraked manner.

7 Malfunctions and error correction

7.2 Table of error codes

Error no.	Kind of error	Measures	Note
1-9	System error	<ul style="list-style-type: none"> Allow to slow down Power off/on 	All these errors stop the centrifuge or cause it to decelerate brakeless
10-19	Speedometer error	<ul style="list-style-type: none"> Allow to slow down Power off/on 	
20-29	Motor error	<ul style="list-style-type: none"> Power off Ensure ventilation 	
30-39	EEPROM error	<ul style="list-style-type: none"> Allow to slow down Power off/on 	With error 34, 35, and 36, the centrifuge will stop; with error 37 and 38 only an error message will be given
40-45	Temperature error (only for refrigerated centrifuges)	<ul style="list-style-type: none"> Allow to slow down Power off Allow to cool down Provide better ventilation (only air cooled centrifuges) Provide sufficient water throughput (only water cooled centrifuges) 	
46-49	Imbalance error	<ul style="list-style-type: none"> Allow to slow down Power off Eliminate the imbalance 	
50-59	Lid error	<ul style="list-style-type: none"> Press lid key Close lid Remove foreign matter from the opening of the lid lock device 	With error 50 and 51, the centrifuge will stop
60-69	Process error	<ul style="list-style-type: none"> Allow to slow down Power off/on 	With error 60 message "power failure during run", with error 61, the message "stop after power on"
70-79	Communication error	<ul style="list-style-type: none"> Allow to slow down Power off/on 	
80-89	Parameter error	<ul style="list-style-type: none"> Power off Allow to cool down Provide for better ventilation 	With error 83, error message only
90-99	Other errors	<ul style="list-style-type: none"> Check connections Provide sufficient water throughput (only water cooled centrifuges) 	



NOTE

If it is impossible to eliminate the errors, contact the service!

7 Malfunctions and error correction

7.3 Service contact

In the event of queries, malfunctions, or spare part enquiries:

From Germany:

Contact

Sigma Laborzentrifugen GmbH
An der Unteren Söse 50
37520 Osterode (Germany)
Tel. +49 (0) 55 22 / 50 07-44 44
E-mail: support.lab@sigma-zentrifugen.de

Outside Germany:

Contact our agency in your country. All agencies are listed at
www.sigma-zentrifugen.de → [Sales Partners]



NOTE

- If you would like to utilise our service, please state the type of your centrifuge and its serial number.

8 Maintenance and service

The centrifuge, rotor, and accessories are subject to high mechanical stress. Thorough maintenance performed by the user extends the service life and prevents premature failure.



CAUTION

If corrosion or other damage occurs due to improper care, the manufacturer cannot be held liable or subject to any warranty claims.

- Use soap water or other water-soluble, mild cleaning agents with a pH value between 6 and 8 for cleaning the centrifuge and accessories (see also).
- Avoid corrosive and aggressive substances.
- Do not use solvents.
- Do not use agents with abrasive particles.
- Do not expose the centrifuge and rotors to intensive UV radiation or thermal stress (e.g. by heat generators).

8.1 Maintenance

8.1.1 Centrifuge

- Unplug the mains power plug before cleaning.
- Carefully remove all liquids, including water and particularly all the solvents, acids, and alkaline solutions from the rotor chamber using a cloth in order to avoid damage to the motor bearings.
- If the centrifuge has been contaminated with toxic, radioactive, or pathogenic substances, clean the rotor chamber immediately with a suitable decontamination agent (depending on the type of contamination).



WARNING

Take suitable precautions for your own safety if there is a risk of toxic, radioactive, or pathogenic contamination.

- Grease the motor shaft slightly after cleaning (grease for load-bearing bolts part no. 70284).

8 Maintenance and service

8.1.2 Accessories



CAUTION

For the care of the accessories, special safety measures must be considered as these are measures that will ensure operational safety at the same time!

- Immediately rinse off the rotor, buckets, or accessories under running water if they have come into contact with any liquids that may cause corrosion. Use a brush for test tubes in order to clean the bores of angle rotors. Turn the rotor upside down and allow it to dry completely.
- Clean the accessories outside the centrifuge once a week or preferably after each use. Adapters should be removed, cleaned and dried.



CAUTION

Do not clean the accessories in a dishwasher!

Cleaning in a dishwasher removes the anodised coating; the result is cracking in areas that are subject to stress.

- If the rotors or accessories have been contaminated with toxic, radioactive, or pathogenic substances, clean them immediately with a suitable decontamination agent (depending on the type of contamination). Take suitable precautions for your own safety if there is a risk of toxic, radioactive, or pathogenic contamination.
- Dry the accessories with a soft cloth or in a drying chamber at approx. 50°C.

8.1.2.1 Plastic accessories

The chemical resistance of plastic decreases with rising temperatures (see chapter 11.4 - "Resistance data").

- If solvents, acids, or alkaline solutions have been used, clean the plastic accessories thoroughly.



WARNING

Plastic accessories must not be greased!

8.1.3 Rotors, buckets and carriers

Rotors, buckets and carriers are produced with the highest precision, in order to withstand the permanent high stress from high gravitational fields. Chemical reactions as well as stress-corrosion (combination of oscillating pressure and chemical reaction) can affect or destroy the metals. Barely detectable cracks on the surface can expand and weaken the material without any visible signs.

- Check the material regularly (at least once a month) for
 - cracks
 - visible damage of the surface
 - pressure marks
 - signs of corrosion
 - other changes.

- Check the bores of the rotors and multiple carriers.
- Replace any damaged components immediately for your own safety.
- Grease the rotor tie-down screw after cleaning with grease for load bearing bolts (part no. 70284) and spread the grease with a cloth.

8.1.4 Microhaematocrit rotor

- Remove the microhaematocrit rotor for cleaning.
- Wipe the centrifuge chamber clean.
- Replace the rubber ring in the event of wear or glass breakage (part no. 16001 for rotor 11409).

8.1.5 Load bearing bolts

Only greased load bearing bolts ensure the even swinging of the buckets and, therefore, the quiet run of the centrifuge. Non-greased bolts can lead to a system shut-down due to imbalances.

Apply a small quantity of grease (part no. 70284) to the load bearing bolts of the rotor and buckets after each cleaning.

8 Maintenance and service

8.1.6 Glass breakage



CAUTION

In the case of glass breakage, immediately remove all glass particles (e.g. with a vacuum cleaner). Replace the rubber cushions since even thorough cleaning will not remove all glass particles.

Glass particles will damage the surface coating (e.g. anodising) of the buckets, which will then lead to corrosion.

Glass particles in the rubber cushions of the buckets will cause glass breakage again.

Glass particles on the pivot bearing of the load-bearing bolts prevent the buckets and carriers from swinging evenly, which will cause an imbalance.

Glass particles in the rotor chamber will cause metal abrasion due to the strong air circulation. This metal dust will not only pollute the rotor chamber, rotor, and materials to be centrifuged but also damage the surfaces of the accessories, rotors, and rotor chamber.

In order to completely remove the glass particles and metal dust from the rotor chamber:

- Grease the upper third of the rotor chamber with e.g. Vaseline.
- Then, let the rotor rotate for a few minutes at a moderate speed (approx. 2000 rpm). The glass and metal particles will now collect at the greased part.
- Remove the grease with the glass and metal particles with a cloth.
- If necessary, repeat this procedure.

8.2 Sterilisation and disinfection of the rotor chamber and accessories

- Use commercially-available disinfectants such as, for example, Sagrotan[®], Buraton[®], or Terralin[®] (available at chemist's shops or drugstores).
- The centrifuge and the accessories consist of various materials. A possible incompatibility must be considered.
- Before using cleaning or decontamination agents that were not recommended by us, contact the manufacturer to ensure that such a procedure will not damage the centrifuge.
- For autoclaving, consider the continuous heat resistance of the individual materials (see chapter 8.2.1 - "Autoclaving").

Please contact us if you have any queries (see chapter 7.3 - "Service contact").



DANGER

If dangerous materials (e.g. infectious and pathogenic substances) are used, the centrifuge and accessories must be disinfected.

8.2.1 Autoclaving

The service life of the accessories essentially depends on the frequency of autoclaving and use.

- Replace the accessories immediately when the parts show changes in colour or structure or in the occurrence of leaks etc.
- During autoclaving, the caps of the tubes must not be screwed on in order to avoid the deformation of the tubes.

NOTE

It cannot be excluded that plastic parts, e.g. lids or carriers, may deform during autoclaving.

Accessories	Max. temp. (°C)	Min. time (min)	Max. time (min)	Max. cycles
Aluminium buckets	134-138	3	5	-
Aluminium rotors	134-138	3	5	-
Glass tubes	134-138	3	40	-
Polyallomer / polycarbonate rectangular carriers	115-118	30	40	-
Polyallomer / polycarbonate round carriers	115-118	30	40	-
Polyamide buckets	115-118	30	40	10
Polycarbonate / polyallomer lids for angle rotors	115-118	30	40	20
Polycarbonate tubes	115-118	30	40	20
Polyphenylsulfone (PPSU) caps for buckets	134-138	3	5	100
Polypropylene balance adapter for blood-bag systems	115-118	30	40	n.s.
Polypropylene copolymer tubes	115-121	30	40	20
Polypropylene rectangular carriers	115-118	30	40	-
Polypropylene rotors	115-118	30	40	20
Polypropylene round carriers	115-118	30	40	-
Polysulfone caps for buckets	134-138	3	5	100
Polysulfone lids for angle rotors	134-138	3	5	100
Rubber adapters	115-118	30	40	-
Stainless-steel balance weight for blood-bag systems	121	30	30	n.s.
Teflon tubes	134-138	3	5	100

8 Maintenance and service

8.3 Service



DANGER

In the event of service work that requires the removal of the panels, there is a risk of electric shock or mechanical injury. Only qualified specialist personnel is authorised to perform this service work.

The centrifuge is subject to high mechanical stress. In order to be able to withstand this high level of stress, high-quality components were used during the production of the centrifuge. Nevertheless, wear cannot be excluded and it may not be visible from the outside. Especially the rubber parts that are – among other things – part of the motor suspension, are subject to ageing.

This is why we recommend having the centrifuge checked by the manufacturer during an inspection once per year in the operating state and once every three years in the dismantled state. Rubber parts should be replaced after three years.

Information and appointments:

In Germany:

Contact

Sigma Laborzentrifugen GmbH

An der Unteren Söse 50

37520 Osterode (Germany)

Tel. +49 (0) 55 22 / 50 07-44 44

E-mail: support.lab@sigma-zentrifugen.de

Outside Germany:

Contact our agency in your country. All agencies are listed at www.sigma-zentrifugen.de → [Sales Partners]



NOTE

- If you would like to utilise our service, please state the type of your centrifuge and its serial number.

8.4 Return of defective parts

Although we exercise great care during the production of our products, it may be necessary to return a unit or accessory to the manufacturer.

In order to ensure the quick and economical processing of returns of centrifuges, spare parts, or accessories, we require complete and extensive information concerning the process. Please fill in the following forms completely, sign them, enclose them with the return package, and send them together with the product to:

Sigma Laborzentrifugen GmbH
An der Unteren Söse 50
37520 Osterode (Germany)

1. Declaration of decontamination

As a certified company and due to the legal regulations for the protection of our employees and of the environment, we are obliged to certify the harmlessness of all incoming goods. For this purpose, we require a declaration of decontamination.

- The form must be filled in completely and signed by authorised and specialised personnel only.
- Affix the original form in a clearly visible manner to the outside of the packaging.



NOTE

We will return the unit if no declaration of decontamination is provided!

2. Form for the return of defective parts

This form is for the product-related data. They facilitate the assignment, and they enable the quick processing of the return. If several parts are returned together in one packaging, please enclose a separate problem description for every defective part.

- A detailed problem description is necessary in order to perform the repair quickly and economically.



NOTE

If the form does not include a description of the malfunction, neither a refund nor a credit note can be issued. In this case, we reserve the right to return the parts to you at your expense.

- Upon request, we will prepare and submit to you a cost estimate prior to performing the repair. Please confirm such cost estimate within 14 days. If the cost estimate has still not been confirmed after 4 weeks, we will return the unit. Please note that you must bear the incurred costs.

8 Maintenance and service



The unit must be packaged in a transport-safe manner. Please use the original packaging, if at all possible.

If the product is dispatched to us in unsuitable packaging, you will be charged the cost for returning it to you in new packaging.

The forms can be downloaded online from
www.sigma-zentrifugen.de → [Service] → [Overhaul and repair].

9 Disposal

9.1 Disposal of the centrifuge



In accordance with the directive 2002/96/EC, SIGMA centrifuges are marked with the symbol shown to the left. This symbol means that it is not permissible to dispose of the unit among household waste.

- You can return these centrifuges free of cost to Sigma Laborzentrifugen GmbH.
- Ensure that the unit is decontaminated. Fill in a declaration of decontamination (see chapter 8.4 - "Return of defective parts").
- Comply with any other applicable local rules and regulations.

9.2 Disposal of the packaging

- Use the packaging to return the centrifuge for disposal or
- dispose of the packaging, after having separated the individual materials.
- Comply with all local rules and regulations.

10 Technical data

10 Technical data

Manufacturer	Sigma Laborzentrifugen GmbH An der Unteren Söse 50 37520 Osterode (Germany)
Type:	2-16P
<u>Connection requirements</u>	
Electr. connection:	see name plate
Protection class:	I
IP code:	20
Connected load (kVA):	0.30
Power consumption (kW):	0.34
Max. current consumption (A):	1.4 (at 220-240 V / 50 Hz) 2.8 (at 120 V / 60 Hz)
Input fuse (AT):	4.0 (at 220-240 V / 50 Hz)
<u>Performance data</u>	
Max. speed (rpm):	15,000
Max. capacity (ml):	408
Max. gravitational field (x g):	20,627
Max. kin. energy (Nm):	7,756
<u>Other parameters</u>	
Time range:	10 sec – 11h 59 min, short run, continuous run
Storage locations:	50
<u>Physical data</u>	
Height (mm):	300
Height with open lid (mm):	610
Width (mm):	365
Depth (mm):	452
Weight (kg):	32
Noise level (dB(A)):	< 67 (at maximum speed)

10.1 Ambient conditions

- The figures are valid for an ambient temperature of $+23^{\circ}\text{C} \pm 2^{\circ}\text{C}$ and a nominal voltage $\pm 10\%$.



NOTE

At a nominal voltage of 100V or 200V, a tolerance of +10% / -5% applies.

- For indoor use only.
- Allowable ambient temperature $+5^{\circ}\text{C}$ to $+40^{\circ}\text{C}$.
- Max. relative humidity of air 80% up to 31°C with a linear decrease to 50% relative humidity of air at 40°C .
- Maximum altitude 2,000 m above sea level.

10.2 Technical documentation

For environmental reasons, the comprehensive technical documentation of the centrifuge (e.g. circuit diagrams) and the safety data sheets of the manufacturers of refrigerant and lubricants are not attached to this documentation.

You can order these documents from our service department.

11 Appendix

11 Appendix

11.1 Range of accessories

Part no.	Description	Max. speed (rpm)	Max. gravitational field (x g)
11122	Swing-out rotor for microtiter plates, incl. 1 set carriers no. 13222, max. height of plates 56 mm, max. load per bucket approx. 335 gram Radius max. 12.3 cm, radius min. 4.8 cm	3 000	1 238
11123	Swing-out rotor for microtiter plates, incl. 1 set carriers no. 13223, max. height of plates 50 mm, max. load per bucket approx. 345 gram Radius max. 11.9 cm, Radius min. 4.8 cm	4 000	2 111
11124	Swing-out rotor 24 x 1.5 / 2.0 ml, incl. 3 sets buckets no. 13124, for e.g. reaction vials no. 15008, 15040, incl. hermetic aluminium lid no. 17878 Radius max. 7.4 cm, radius min. 3.5 cm	12 500	12 927
11170	Swing-out rotor, 4 place, for bucket no. 13299, suitable for software version 27 or higher Radius max. 14.2 cm, radius min. 3.8 cm	4 500	3 215
11190	Swing-out rotor 4 x 100 ml complete, no. 11192, incl. 2 sets bucket no. 13097 and 4 glass tubes 100 ml no. 15100 Radius max. 13.5 cm, radius min. 5.0 cm	4 500	3 056
11191	Swing-out rotor 16 x 15 ml complete, no. 11192, incl. 2 sets carriers no. 13012 and 16 PS-tubes 15 ml no. 15020 Radius max. 13.4 cm, radius min. 5.1 cm	4 500	3 034
11192	Swing-out rotor, 4 place, for buckets no. 13009, 13012, 13041, 13042, 13097, 13150, 13152, buckets 13041 and 13152 for rotors from the year 2003 onwards only	4 500	
11409	Microhematocritrotor suitable for 24 capillary tubes Ø 1.5 x 75 mm, 50 µl no. 15001, incl. reader no. 17029, usable with reader 17002, incl. rotor screw 81543 Radius max. 9.0 cm, radius min. 1.5 cm	12 000	14 489
12071	Angle rotor for 12 x 15 ml culture tubes, e.g. no. 15115 and 6 x 50 ml culture tubes, e.g. no. 15151, angle 35°, Radius max. 12.6 cm, radius min. 5.4 cm	4 000	2 254
12072	Angle rotor 20 x 15 ml complete, incl. 10 sets buckets no. 13011, for tubes Ø 17 x up to 120 mm, e.g. no. 15015, 15020, 15023, 15024, Monovettes and culture tubes 15 ml no. 15115 Radius max. 13.9 cm, radius min. 8.0 cm, angle 33°	4 000	2 486
12073	Angle rotor 30 x 15 ml complete, incl. 15 sets buckets no. 13011, for tubes Ø 17 x up to 120 mm, e.g. no. 15015, 15020, 15023, 15024, Monovettes and culture tubes 15 ml no. 15115, angle 33° Radius max. 13.9 cm, radius min. 5.8 cm	4 000	2 486
12133	Angle rotor 30 x 1.5/2.0 ml, for e.g. reaction vials no. 15008, 15040, incl. hermetic aluminium lid no. 17863 Radius max. 10.0 cm, radius min. 6.7 cm, angle 45°	12 000	16 099
12139	Angle rotor 6 x 30 ml, for tubes no. 15029, 15030, 15032, incl. hermetic aluminium lid no. 17851 Radius max. 7.8 cm, radius min. 2.1 cm, angle 29° Attention! Rotors from batch number 201/00 may be run <u>with</u> lid, rotors of older batches (e.g. 15/00 or ../99) have to be run <u>without</u> lid.	13 500	15 893
12141	Angle rotor 10 x 10 ml, for tubes no. 15000, 15010, 15039, incl. hermetic aluminium lid no. 17850 Radius max. 7.6 cm, radius min. 2.8 cm, angle 35°	13 500	15 485

11 Appendix

Part no.	Description	Max. speed (rpm)	Max. gravitational field (x g)
12148	Angle rotor 24 x 1.5/2.0 ml, for e.g. reaction vials no. 15008, 15040, incl. hermetic aluminium lid no. 17864 Radius max. 8.2 cm, radius min. 4.9 cm, angle 45°	15 000	20 627
12180	Angle rotor 12 x 5 ml, Eppendorf reaction caps, incl. hermetic aluminium lid no. 17180, suitable for software version 27 or higher Radius max. 8.0 cm, radius 3.9 cm, angle 40°	14 000	17 530
12181	Angle rotor for 6 x 50 ml culture tubes, e.g. no. 15151, incl. hermetic aluminium lid no. 17931, suitable for software version 26 or higher Radius max. 9.5 cm, radius 3.0 cm, angle 28°	10 000	10 621
13009	Multiple carrier for 5 tubes 5 ml, round and flat bottom, incl. rubber cushion no. 16005, max. Ø 12. 8/16.5 x 65 - 85 mm, e.g. no. RIA tube 15060, vacutainer, hemolyse tubes, 1 set = 2 pcs. Radius max. 11.3 cm, radius min. 5.6 cm	4 500	2 558
13012	Multiple carrier for 4 tubes 5 - 15 ml, round bottom, incl. rubber cushion no. 16015, max. Ø 17/19 x 90 - 105 mm, e.g. no. 15015, 15020, 15023, 15024, Monovettes 9 - 10 ml, 1 set = 2 pcs. Radius max. 13.4 cm, radius min. 5.1 cm	4 500	3 034
13041	Round bucket for round carriers Ø 43.5 mm, no. 14028 -14035, incl. polysulfone screw cap no. 17130, max. tube length 110 mm, 1 set = 2 pcs. Radius max. 14.0 cm, radius min. 3.0 cm	4 500	3 170
13042	Multiple carrier for 6 tubes 5 to 15 ml, round bottom, max. Ø 17/19 x 80 - 105 mm, e.g. no. 15000, 15010, 15015, 15020, 15023, 15024, 15039, Monovettes 9 - 10 ml, Vacutainer, incl. rubber cushion no. 16020, 1 set = 2 pcs. Radius max. 13.3 cm, radius min. 4.9 cm	4 500	3 011
13097	Round bucket for 1 tube 100 ml, incl. rubber cushion no. 16051, max. Ø 45.5 x 95 - 105 mm, e.g. no. 15100, 15102, 15103, 15106 and adapters no. 17925, 17950, 1 set = 2 pcs. Radius max. 13.5 cm, radius min. 5.0 cm	4 500	3 056
13150	Bucket incl. polysulfone screw cap no. 17151 for 1 culture tube 50 ml, e.g. no. 15151, 1 set = 2 pcs.		
13152	Multiple carrier for 2 culture tubes 15 ml, e.g. no. 15115, 1 set = 2 pcs. Radius max. 14.3 cm, radius min. 3.3 cm		
13299	Round bucket, sealable with cap no. 17299, for round carriers no. 14299 - 14310, 1 set = 2 pcs.		

11 Appendix

Adapters

Part no.	Description
13000	Adapter for reaction vials 0.25/0.4 ml no. 15014, 1 set = 2 pcs., suitable for 11124, 12133, 12148
13002	Adapter for reaction vials 0.5/0.75 ml, Ø 7.9/10 x 28/31 mm, e.g. no. 15005, 1 set = 2 pcs., suitable for 11124, 12133, 12148
13021	Adapter for PCR-tube 0.2 ml, e.g. no. 15042, 1 set = 2 pcs., suitable for 11124, 12133, 12148
13059	Adapter for 1 round bottom tube 10 ml, max. Ø 16.2/19 x 75 - 85 mm, e.g. no. 15000, 15010, 15039, 1 set = 2 pcs., suitable for 12139
13060	Adapter for 1 culture tube 15 ml no. 15115, 1 set = 2 pcs.
13079	Bottom adapter for 1 tube 50 ml, e.g. no. 15051, 15052, 1 set = 2 pcs.

The complete list of accessories can be downloaded from www.sigma-zentrifugen.de.

11.1.1 Maximum speed for tubes

Some tubes, such as centrifuge glass tubes, microtubes, culture tubes, fluoropolymer tubes and especially high-volume tubes can be used in our rotors, buckets, and adapters at higher speeds than their breaking limit.

- Always fill the tubes up to their useful volume (= the volume that is stated for the tube).
- When using glass tubes, the maximum value of 4,000 x g must not be exceeded (except special high-strength glass tubes; please refer to the information provided by the manufacturer).

11.1.2 Rotor radii

The information in the accessories table concerning the radius refers to the values of the respective rotor as shown below. The radius calculation is described in (see chapter 2.2.2.1 - "Speed, radius, and relative centrifugal force").

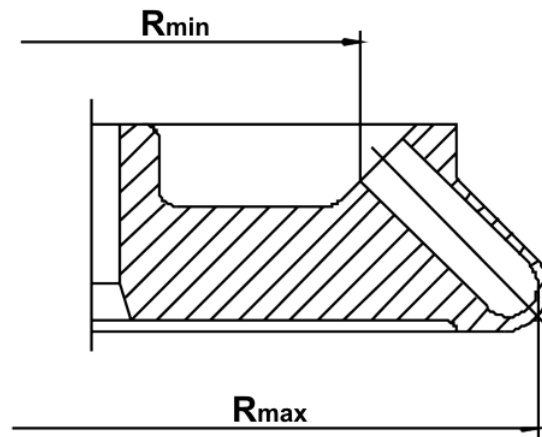

Fig. 21: Minimum and maximum radius of an angle rotor

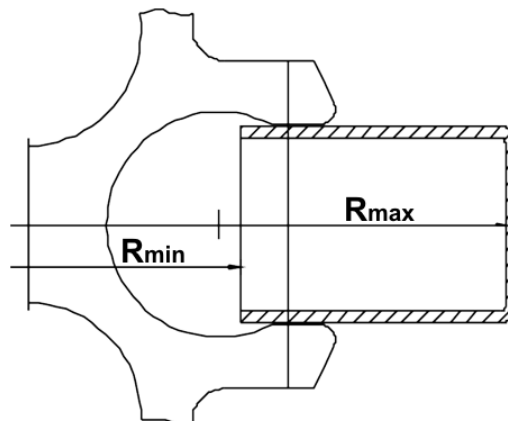

Fig. 22: Minimum and maximum radius of a swing-out rotor

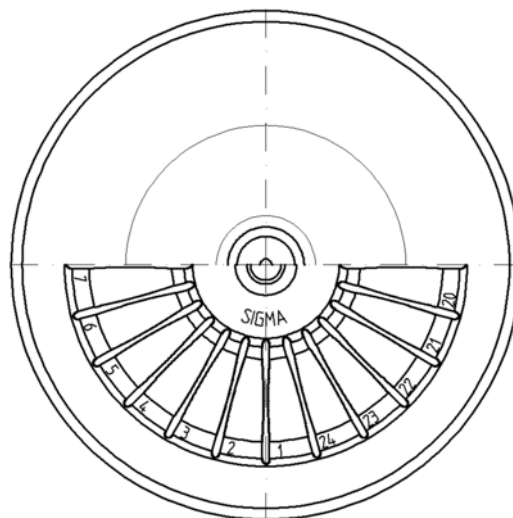

Fig. 23: Microhaematocrit rotor

11 Appendix

11.2 Speed-gravitational-field-diagram

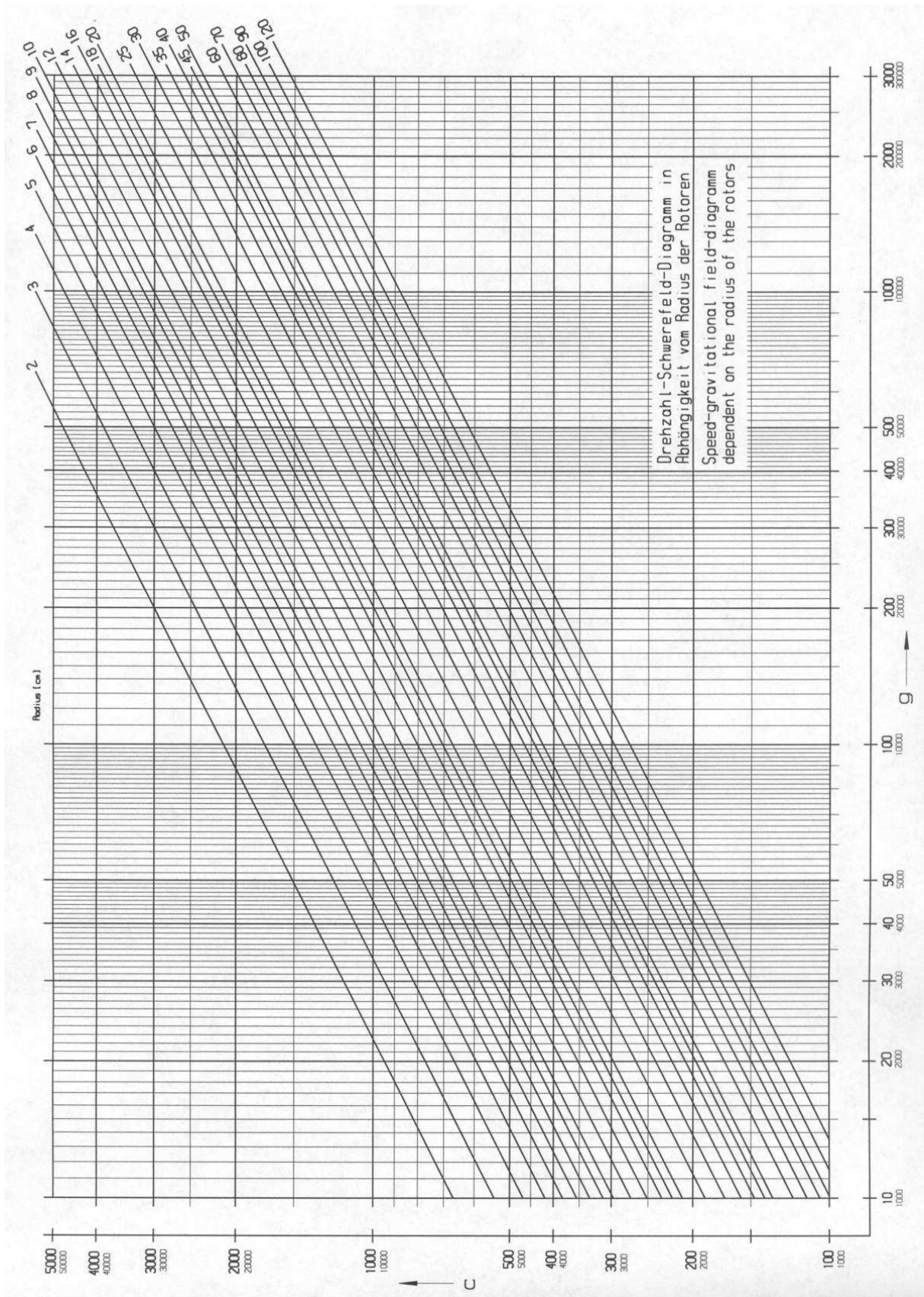



Fig. 24: Speed-gravitational-field-diagram

11.3 Table of the service life of rotors and accessories

Rotors and accessories with a different service life					
If no other data concerning the service life are engraved on the rotor or accessory, rotors and buckets must be checked by the manufacturer after 10 years. After 50,000 cycles, rotors must be scrapped for safety reasons.					
Rotor / bucket	Cycles	Service life ("Exp.Date")	Autoclaving	Suitable for centrifuge	Remarks
9100	15,000			4-15C, 4K15C, 4-16, 4-16S, 4-16K, 4-16KS, 6-15, 6K15, 6-16, 6-16K	without engraving, only "spincontrol professional" and "spincontrol S"
11026		7 years		1-14, 1-14K	
12033		5 years		1-16 Edition, 1-16K Edition	
12082		7 years		1-14, 1-14K	
12083		7 years		1-14, 1-14K	
12084		7 years		1-14, 1-14K	
12085		7 years		1-14, 1-14K	
12092		5 years	20x	1-14, 1-14K	
12093		5 years	20x	1-14, 1-14K	
12094		5 years	20x	1-14, 1-14K	
12096		5 years	20x	1-14, 1-14K	
12101		5 years	20x	1-15, 1-15K, 1-15P, 1-15PK	
12124		5 years	20x	1-15, 1-15K, 1-15P, 1-15PK	
12126		5 years	20x	1-15, 1-15K, 1-15P, 1-15PK	
12134		5 years	20x	1-16, 1-16K	
12135		5 years	20x	1-16, 1-16K	
12137		5 years	20x	1-16, 1-16K	
12500		7 years		6-15, 6K15, 6-16, 6-16K	
12600		7 years		6-16S, 6-16KS	
13218	20,000			4-16, 4-16S, 4-16K, 4-16KS, 6-16, 6-16S, 6-16K, 6-16KS	
13296		5 years	10x	2-6, 2-6E, 2-7	
13299		5 years	10x	2-6, 2-6E, 2-7, 2-16P, 2-16KL, 2-16KHL	
13635	25,000			6-16, 6-16K, 6-16S, 6-16KS	
13845	20,000			8K, 8KS	
13850	10,000			8K, 8KS, 8KBS	
13860	35,000			8K, 8KS, 8KBS	
13864	1,000			8K, 8KS	without engraving
13865	1,000			8K, 8KS	without engraving
13866	1,000			8K, 8KS	without engraving

11 Appendix

11.4 Resistance data

i

NOTE

The data refer to resistance at 20°C.

- no data 1 resistant 2 practically resistant 3 partially resistant 4 not resistant	Medium	Formula	Concentration [%]	High Density Polyethylene	Polyamide	Polycarbonate	Polyoxymethylene	Polypropylene	Polysulfone	Polyvinyl chloride, hard	Polyvinyl chloride, weak	Polytetrafluorethylene	Acrylonitrile-butadiene- caoutchouc	Aluminium
				HDPE	PA	PC	POM	PP	PSU	PVC	PVC	PTFE	NBR	AL
	Acetaldehyde	C ₂ H ₄ O	40	3	2	4	2	3	4	4	-	1	4	1
	Acetamide	C ₂ H ₅ NO	saturated	1	1	4	1	1	4	4	-	1	-	1
	Acetone	C ₃ H ₆ O	100	1	1	4	1	1	4	4	-	1	4	1
	Acrylonitrile	C ₃ H ₃ N	100	1	1	4	3	3	4	4	4	1	4	1
	Allyl alcohol	C ₃ H ₆ O	96	1	3	3	2	2	2	2	4	1	1	1
	Aluminium chloride	AlCl ₃	saturated	1	3	2	4	1	-	1	-	1	1	4
	Aluminium sulfate	Al ₂ (SO ₄) ₃	10	1	1	1	3	1	1	1	1	1	1	1
	Ammonium chloride	(NH ₄)Cl	aqueous	1	1	1	2	1	1	1	1	1	1	3
	Ammonium hydroxide	NH ₃ + H ₂ O	30	1	3	4	1	1	2	1	-	1	-	1
	Aniline	C ₆ H ₇ N	100	1	3	4	1	2	4	4	4	1	4	1
	Anisole	C ₇ H ₈ O	100	3	4	4	1	4	4	2	-	1	4	1
	Antimony trichloride	SbCl ₃	90	1	4	1	4	1	-	1	-	1	-	4
	Benzaldehyde	C ₇ H ₆ O	100	1	3	4	1	1	3	4	4	1	4	1
	Benzene	C ₆ H ₆	100	3	2	4	1	3	4	4	-	1	4	1
	Boric acid	H ₃ BO ₃	aqueous	1	3	1	2	1	-	-	-	1	1	1
	Butyl acrylate	C ₇ H ₁₂ O ₂	100	1	2	4	2	3	4	4	4	1	-	1
	Butyl alcohol, normal	C ₄ H ₁₀ O	100	1	1	2	1	1	2	2	4	1	1	1
	Calcium chloride	CaCl ₂	alcoholic	1	4	2	3	1	-	-	4	1	1	3
	Carbon disulfide	CS ₂	100	4	3	4	2	4	4	4	4	1	3	1
	Carbon tetrachloride (TETRA)	CCl ₄	100	4	4	4	2	4	4	4	4	1	3	1
	Chlorine	Cl ₂	100	4	4	4	4	4	4	4	4	1	-	3
	Chlorine water	Cl ₂ x H ₂ O		3	4	4	4	3	-	3	3	1	-	4
	Chlorobenzene	C ₆ H ₅ Cl	100	3	4	4	1	3	4	4	4	1	4	1
	Chloroform	CHCl ₃	100	3	3	4	4	3	4	4	4	1	4	3

11 Appendix

- no data 1 resistant 2 practically resistant 3 partially resistant 4 not resistant	Medium	Formula	Concentration [%]	High Density Polyethylene	Polyamide	Polycarbonate	Polyoxymethylene	Polypropylene	Polysulfone	Polyvinyl chloride, hard	Polyvinyl chloride, weak	Polytetrafluorethylene	Acrylonitrile-butadiene- caoutchouc	Aluminium
				HDPE	PA	PC	POM	PP	PSU	PVC	PVC	PTFE	NBR	AL
	Chromic acid	CrO ₃	10	1	4	2	4	1	4	1	-	1	4	1
	Chromic potassium sulphate	KCr(SO ₄) ₂ x 12H ₂ O	saturated	1	2	1	3	1	-	1	-	1	-	3
	Citric acid	C ₆ H ₈ O ₇	10	1	1	1	2	1	1	1	1	1	1	1
	Citric acid	C ₆ H ₈ O ₇	50	1	3	1	2	1	-	-	-	1	1	1
	Copper sulphate	CuSO ₄ x 5H ₂ O	10	1	1	1	1	1	1	1	1	1	1	4
	Cyclohexanol	C ₆ H ₁₂ O	100	1	1	3	1	1	1	1	4	1	2	1
	Decane	C ₁₀ H ₂₂	100	-	1	2	1	3	-	-	-	1	2	1
	Diaminoethane	C ₂ H ₈ N ₂	100	1	1	3	1	1	-	3	4	1	1	1
	Diesel fuel	—	100	1	1	3	1	1	-	1	3	1	1	1
	Dimethyl formamide (DMF)	C ₃ D ₇ NO	100	1	1	4	1	1	4	3	-	1	3	1
	Dimethyl sulfoxide (DMSO)	C ₂ H ₆ SO	100	1	2	4	1	1	4	4	-	1	-	1
	Dimethylaniline	C ₈ H ₁₁ N	100	-	3	4	2	4	-	-	-	1	-	1
	Dioxane	C ₄ H ₈ O ₂	100	2	1	4	1	3	2	3	4	1	3	1
	Dipropylene glycol (mono)methyl ether	C ₄ H ₁₀ O	100	3	1	4	1	4	4	4	4	1	-	1
	Ethyl acetate	C ₄ H ₈ O ₂	100	1	1	4	1	1	4	4	4	1	4	1
	Ethylene chloride	C ₂ H ₄ Cl ₂	100	3	3	4	1	3	4	4	4	1	-	1
	Ferrous chloride	FeCl ₂	saturated	1	3	1	3	1	1	1	1	1	-	4
	Formaldehyde solution	CH ₂ O	30	1	3	1	1	1	-	-	-	1	2	1
	Formic acid	CH ₂ O ₂	100	1	4	3	4	1	3	3	1	1	2	1
	Furfural	C ₅ H ₄ O ₂	100	1	3	3	2	4	-	-	-	1	4	1
	Gasoline	C ₅ H ₁₂ - C ₁₂ H ₂₆	100	2	1	3	1	3	3	2	-	1	1	1
	Glycerol	C ₃ H ₈ O ₃	100	1	1	3	1	1	1	1	2	1	1	1
	Heptane, normal	C ₇ H ₁₆	100	2	1	1	1	2	1	2	4	1	1	1
	Hexane, n-	C ₆ H ₁₄	100	2	1	2	1	2	1	2	4	1	1	1
	Hydrogen chloride	HCl	5	1	4	1	4	1	1	1	-	1	2	4
	Hydrogen chloride	HCl	concentrated	1	4	4	4	1	1	2	3	1	4	4
	Hydrogen peroxide	H ₂ O ₂	3	1	3	1	1	1	1	1	-	1	3	3
	Hydrogen peroxide	H ₂ O ₂	30	1	4	1	4	1	1	1	-	1	3	3
	Hydrogen sulphide	H ₂ S	10	1	1	1	1	1	1	1	3	1	3	1
	Iodine, tincture of	I ₂		1	4	3	1	1	-	4	4	1	1	1

11 Appendix

- no data 1 resistant 2 practically resistant 3 partially resistant 4 not resistant	Medium	Formula	Concentration [%]	High Density Polyethylene	Polyamide	Polycarbonate	Polyoxymethylene	Polypropylene	Polysulfone	Polyvinyl chloride, hard	Polyvinyl chloride, weak	Polytetrafluorethylene	Acrylonitrile-butadiene- caoutchouc	Aluminium
				HDPE	PA	PC	POM	PP	PSU	PVC	PVC	PTFE	NBR	AL
	Isopropyl alcohol	C ₃ H ₈ O	100	1	1	1	1	1	1	1	4	1	-	2
	Lactic acid	C ₃ H ₆ O ₃	3	1	3	1	2	1	1	2	-	1	1	1
	Magnesium chloride	MgCl ₂	10	1	1	1	1	1	1	1	1	1	1	1
	Mercuric chloride	HgCl ₂	10	1	4	1	3	1	1	1	1	1	1	4
	Mercury	Hg	100	1	1	1	1	1	1	1	3	1	1	3
	Methyl acetate	C ₃ H ₆ O ₂	100	1	1	4	2	1	-	4	4	1	-	1
	Methyl alcohol	CH ₄ O	100	1	2	4	1	1	3	1	3	1	2	1
	Methyl benzene	C ₇ H ₈	100	3	1	4	1	3	4	4	4	1	4	1
	Methyl ethyl ketone (MEK)	C ₄ H ₈ O	100	1	1	4	1	1	4	4	4	1	4	1
	Methylene chloride	CH ₂ Cl ₂	100	4	3	4	3	3	4	4	4	1	-	1
	Mineral oil	—	100	1	1	1	1	1	1	1	-	1	1	1
	Nitric acid	HNO ₃	10	1	4	1	4	1	1	1	-	1	4	3
	Nitric acid	HNO ₃	100	4	4	4	4	4	-	4	-	1	4	1
	Nitrobenzene	C ₆ H ₅ NO ₂	100	3	4	4	3	2	4	4	4	1	4	1
	Oleic acid	C ₁₈ H ₃₄ O ₂	100	1	1	1	2	1	-	1	-	1	3	1
	Oxalic acid	C ₂ H ₂ O ₄ x 2H ₂ O	100	1	3	1	4	1	1	1	1	1	2	1
	Ozone	O ₃	100	3	4	1	4	3	1	1	-	1	4	2
	Petroleum	—	100	1	1	3	1	1	1	1	3	1	1	1
	Phenol	C ₆ H ₆ O	10	1	4	4	4	1	4	1	3	1	3	1
	Phenol	C ₆ H ₆ O	100	2	4	4	4	1	3	4	3	1	3	1
	Phosphoric acid	H ₃ PO ₄	20	1	4	2	4	1	-	-	-	1	2	4
	Phosphorus pentachloride	PCl ₅	100	-	4	4	4	1	-	4	4	1	-	1
	Potassium hydrogen carbonate	CHKO ₃	saturated	1	1	2	1	1	-	-	-	1	-	4
	Potassium hydroxide	KOH	30	1	1	4	3	1	1	1	1	1	-	4
	Potassium hydroxide	KOH	50	1	1	4	3	1	1	1	1	1	-	4
	Potassium nitrate	KNO ₃	10	1	1	1	1	1	-	-	-	1	1	1
	Potassium permanganate	KMnO ₄	100	1	4	1	1	1	-	1	-	1	3	1
	Pyridine	C ₅ H ₅ N	100	1	1	4	1	3	4	4	4	1	4	1
	Resorcinol	C ₆ H ₆ O ₂	5	1	4	2	3	1	4	2	-	1	-	2
	Silver nitrate	AgNO ₃	100	1	1	1	1	1	1	1	1	1	2	4

11 Appendix

Medium	Formula	Concentration [%]	- no data 1 resistant 2 practically resistant 3 partially resistant 4 not resistant										
			High Density Polyethylene HDPE	Polyamide PA	Polycarbonate PC	Polyoxymethylene POM	Polypropylene PP	Polysulfone PSU	Polyvinyl chloride, hard PVC	Polyvinyl chloride, weak PVC	Polytetrafluorethylene PTFE	Acrylonitrile-butadiene-caoutchouc NBR	Aluminium AL
Sodium bisulphite	NaHSO ₃	10	1	1	2	4	1	-	-	-	1	1	1
Sodium carbonate	Na ₂ CO ₃	10	1	1	1	1	1	-	-	-	1	-	3
Sodium chloride	NaCl	30	1	1	1	1	1	1	1	1	1	1	3
Sodium hydroxide	NaOH	30	1	1	4	1	1	1	1	1	1	2	4
Sodium hydroxide	NaOH	50	1	1	4	1	1	1	1	1	-	2	4
Sodium sulfate	Na ₂ SO ₄	10	1	1	1	1	1	1	1	1	1	1	1
Spirits	C ₂ H ₆ O	96	1	1	1	1	1	1	1	3	1	-	1
Styrene	C ₈ H ₈	100	4	1	4	1	3	-	4	4	1	4	1
Sulphuric acid	H ₂ SO ₄	6	1	4	1	4	1	1	1	-	1	2	3
Sulphuric acid	H ₂ SO ₄	fuming	4	4	4	4	4	4	4	4	1	4	3
Tallow	—	100	1	1	1	1	1	-	1	1	1	1	1
Tetrahydrofuran (THF)	C ₄ H ₈ O	100	3	1	4	1	3	4	4	4	1	3	1
Tetrahydronaphthalene	C ₁₀ H ₁₂	100	3	1	4	1	4	4	4	4	1	-	1
Thionyl chloride	Cl ₂ SO	100	4	4	4	2	4	4	4	4	1	-	3
Tin chloride	SnCl ₂	10	1	4	2	2	1	-	-	-	1	1	4
Transformer oil	—	100	1	1	3	3	1	1	1	-	1	1	1
Trichloroethane	C ₂ H ₃ Cl ₃	100	3	3	4	2	4	4	4	4	1	4	4
Urea	CH ₄ N ₂ O	10	1	1	1	1	1	-	-	-	1	1	1
Urine	—	100	1	1	1	1	1	-	1	1	1	-	2
Vinegar	C ₂ H ₄ O ₂	10	1	4	1	1	1	1	1	1	1	2	1
Vinegar	C ₂ H ₄ O ₂	90	1	4	4	4	1	3	1	4	1	-	1
Wax	—	100	-	1	1		1	-	-	-	1	-	1
Wines	—	100	1	1	1	2	1	1	1	1	1	-	4
Xylene	C ₈ H ₁₀	100	3	1	4	1	4	4	4	4	1	4	1

11 Appendix

11.5 EC declaration of conformity



EC – DECLARATION OF CONFORMITY

The product named hereinafter was developed, designed, and manufactured in compliance with the relevant, fundamental safety and health requirements of the listed EC directives and norms.

In the event of modifications that were not authorised by us or if the product is used in a manner that is not in line with the intended purpose, this declaration will be rendered void.

<i>Product name:</i>	Laboratory centrifuge
<i>Product type:</i>	Sigma 2-16P
<i>Order number:</i>	10155, 10156, 10157
<i>Directives:</i>	2006/42/EC Machinery Directive 2014/35/EU Low Voltage Directive 2014/30/EU EMC Directive 2011/65/EU RoHS Directive
<i>Normes:</i>	EN 61010-2-020:2006 EN 61000-3-2:2006, A1:2009, A2:2009 EN 61000-3-3:2013 EN 61326-1:2013

Sigma Laborzentrifugen GmbH

An der Unteren Söse 50
37520 Osterode
Germany

Authorised representative
for CE matters:
Eckhard Tödteberg

Osterode, 01/03/2016



General Manager

CE_2-16P_2015-08-19_en

11 Appendix

12 Index

A

Acceleration time	
- see also the softstart and softstop function	
.....	36
Accessories, cleaning and care.....	44
Acid.....	20, 43, 44
Activating the modification mode.....	33
Adapters	31, 44
Alkaline solutions	20, 43, 44
Ambient conditions.....	52
Ambient temperature	52
Anodised coating	44
Application examples	13
Autoclaving	47
Auto-Lid-Open	37
Automatic lid opening function	37
Automatic rotor identification.....	36

B

Brief mains power failure.....	39
Bucket.....	31
Buckets, cleaning and care	45
Buzzer	37

C

Calling up stored programs	38
Capacity.....	52
Capillary tubes	30
Carrier.....	31
Carrier systems.....	31
Carriers, cleaning and care	45
CE mark in compliance with the directive 2006/42/EC	15
Centrifugation of infectious, toxic, radioactive, or pathogenic substances.....	19
Centrifugation principle	13
Centrifugation with different tube sizes.....	30
Centrifugation with low capacity	31
Centrifuge cannot be started.....	39
Centrifuge decelerates during operation	39
Centrifuge is inclined.....	39
Centrifuge was moved during run	39
Centrifuge, cleaning and care	43
Centrifuges	

- definition.....	9
Changes in colour.....	47
Changes in structure.....	47
Changing the RCF increments.....	35
Changing the speed increments.....	35
Changing the time increments.....	34
Chemical and biological safety.....	19
Chemical resistance of plastic.....	44
Cleaning agents.....	46
Cleaning the bores of angle rotors	44
Cleaning the centrifuge	43
Closing the lid	18, 27
Communication error	41
Condensation.....	26
Condenser dirty	39
Connected load.....	52
Contamination.....	19, 44
Continuous heat resistance.....	46
Continuous run	34
Control system.....	32
Copyright	10
Corrosion	18, 21, 31, 43, 44, 45, 46
Cost estimate.....	49
Cracking	44
Cracks	45
Current consumption.....	52
Customer-provided fuses	26

D

Damage of the surface.....	45
Dangerous goods.....	20
Dangerous materials.....	46
Deceleration time	
- see also the softstart and softstop function	
.....	36
Declaration of conformity	10, 65
Declaration of decontamination.....	49
Declaration of Decontamination	51
Decontamination agent	44, 46
Deformation of tubes.....	47
Density.....	20
Different service life of rotors and accessories	
.....	21, 59

Index

Dimensions	24	Improper loading	39
Direct hazard to the life and health.....	16	Infectious substances	46
Directive 2002/96/EC	51	Inflammable substances	19
Disinfectants	46	Informal safety instructions	17
Disinfection of the rotor chamber and accessories	46	Initial start-up	27
Display.....	32	Input fuse.....	52
Disposal of the centrifuge.....	51	Input lock	37
Disposal of the packaging	51	Inspection by the manufacturer	48
Documentation.....	10	Installation of accessories	30
Drive problem	39	Installation of angle rotors with a hermetically sealed lid	29
E		Installation of rotors and accessories	28
Earth conductor check	22	Installation of the microhaematocrit rotor ...	29
EC declaration of conformity	10, 65	Installation of the rotor	28
EEPROM error.....	41	Installation site	26
Electrical connection	52	Intended use	9
Electrical safety.....	18	Interrupting a centrifugation run	33
Emergency lid release	40	Interrupting a deceleration process	33
Equipotential bonding screw	22	IP code	52
Error correction	39	K	
Error message	39	kin. energy	52
Explanation of the symbols and notes.....	16	L	
Explosive substances	19	Layout of the centrifuge.....	11
F		Leaks	31, 47
Fire preventions	19	Lid cannot be opened	39
Form for the return of defective parts	49	Lid error	41
Functional and operating elements	11	Lid lock device	22
Fuses have tripped	39	Lid lock has not released	39
G		Lid seal sticks	39
General conditions	9	Load bearing bolts, cleaning and care.....	45
Glass breakage.....	46	M	
Glass particles	46	Mains power switch off.....	39
Gravitational field.....	52	Mains switch	11
Grease for load bearing bolts.....	10, 43, 45	Mains voltage.....	18
H		Maintenance	43
Hazard warnings	9, 28, 29, 31	Malfunctions and error correction.....	39
Highly corrosive substances	18	Manual mode	33
I		Manufacturer.....	52
Imbalance	30, 31, 45	Marking of the unit	15
Imbalance error.....	41	Maximum speed for tubes.....	56
Imbalance monitoring system	22	Measures in the event of hazards and accidents	23
Importance of the operating manual.....	9	Mechanical safety	18
Important information	16	Microhaematocrit rotor, cleaning and care .	45

Mode of operation	13	Removal of the transport safety device	25
Motor error	41	Remove glass particles and metal dust from the rotor chamber	46
Motor shaft	25, 28, 29, 43	Responsibility of the operator	17
Multiple carrier	31	Return of centrifuges, spare parts, or accessories	49
N		Return of defective parts	49
Name plate	11, 12	Risk of electrical shock	18
No indication on the display	39	Rotor chamber	43
No power in the mains supply	39	Rotor radii	57
Noise level	52	Rotor selection	36
Non-greased bolts	45	Rotor tie-down screw	28, 29, 45
Notes on safety and hazards	9	Rotor wrench	10, 28, 29
Notes on transport	24	Rotors and accessories with a different service life	21, 59
O		Rotors for microtiter plate formats	28
Online download of forms	50	Rotors, cleaning and care	45
Opening the lid	27	Runtime	33
Operating personnel	17	S	
Operating voltage	26	Safety area	20
Operational safety	44	Safety devices	22
Overseas shipping	24	Safety distance	18, 20, 26
P		Safety instructions	9, 28, 29, 31
Packaging	25	Safety instructions for centrifugation	20
Parameter error	41	Safety, chemical and biological	19
Pathogenic substances	19, 43, 46	Safety, electrical	18
Plastic accessories, cleaning and care	44	Safety, mechanical	18
Potential hazard to the life and health	16	Safety-conscious work	17
Potentially hazardous situation	16	Saving the current settings	38
Power consumption	52	Scope of supply	10
Power cord is not plugged in	39	Selection, display, and modification of data	33
Power supply	26	Serial number	12, 42, 48
Pressure marks	45	Service	48
Prevention of accidents	9	Service contact	42
Problem description	49	Service life	43
Process error	41	Service life of rotors and accessories	21, 59
Programs	38	Service life of the accessories	47
Protection class	26, 52	Service work	48
Q		Set-up and connection	26
Quitting the modification mode	33	Short run	34
R		Softstart and softstop function	36
Radioactive substances	19, 43	Solvents	20, 43, 44
Radius	14	Sound signal (buzzer)	37
Range of accessories	54	Spare part enquiries	42
RCF	35	Speed	14, 35, 52
Relative centrifugal force (RCF)	14, 35		

Index

Speed-gravitational-field-diagram	58	Temperature value not reached	39
Speedometer error	41	Thermal stress	43
Standards and regulations	10	Toxic substances	19, 43
Standstill monitoring system	22	Transport safety device	25
Starting a centrifugation run	33	Tubes	31
Sterilisation of the rotor chamber and accessories	46	Type of connection	26
Storage and transport	24	Type of the centrifuge	42, 48, 52
Storage conditions	24	U	
Storage locations	52	Ungreased load-bearing bolts	39
Stress-corrosion		Units of protection class I	26
see		Useful volume	
corrosion	45	- volume that is stated for the tube	31, 56
Structural changes	19	User interface	32
Supply voltage	26	UV radiation	26, 43
Switching the centrifuge off	38	V	
Switching the centrifuge on	27	Vents	26
System check	22	Vessels	31
System error	39, 41	W	
T		Warranty and liability	9
Table of error codes	41	Wear	48
Table of rotors and accessories with a different service life	21, 59	Weight	24
Technical data	52	Work on the power supply system	18
Technical documentation	53	Y	
Temperature error	41	Year of manufacture	12