

**EBA 280**



**EBA 280 S**



Ⓓ	<b>Bedienungsanleitung</b> .....	<b>8</b>
Ⓔ	<b>Operating Instructions</b> .....	<b>46</b>
Ⓕ	<b>Mode d'emploi</b> .....	<b>83</b>
Ⓘ	<b>Istruzioni per l'uso</b> .....	<b>121</b>

Andreas Hettich GmbH & Co. KG  
Föhrenstraße 12, D-78532 Tuttlingen / Germany  
Phone +49 (0)7461 / 705-0  
Fax +49 (0)7461 / 705-1125  
info@hettichlab.com, service@hettichlab.com  
www.hettichlab.com



© 2014 by Andreas Hettich GmbH & Co. KG

All rights reserved. No part of this publication may be reproduced without the prior written permission of the copyright owner.

Änderungen vorbehalten! , Modifications reserved! , Sous réserve de modifications ! , Con riserva di modifiche!

**AB1101DEENFRIT / 2014**

**EG-Konformitätserklärung**  
**EC Declaration of conformity**  
**Déclaration de conformité CE**  
**Dichiarazione di conformità CE**

des Herstellers / of the manufacturer / du fabricant / del costruttore  
Andreas Hettich GmbH & Co. KG • Föhrenstraße 12 • D-78532 Tuttlingen • Germany

Hiermit erklären wir in alleiniger Verantwortung, dass das bezeichnete Gerät, inklusive dem mit dem Gerät konformitätsbewertetem Zubehör laut Zubehörliste der technischen Dokumentation dieses Geräts, der Richtlinie über In-vitro-Diagnostika 98/79/EG entspricht.

We hereby declare under our sole responsibility that the designated device and its accessories, which are listed in the technical documentation for this device and whose conformity has been assessed together with the device, conform to the Directive 98/79/EC on in vitro diagnostic medical devices.

Par la présente, nous déclarons sous notre seule responsabilité que l'appareil désigné, incluant ses accessoires attestés conformes d'après la liste des accessoires de la documentation technique du dit-appareil, répond à la directive 98/79/CE sur le diagnostic In-vitro.

Si dichiara nella nostra sola responsabilità, che l'apparecchiatura indicata, comprensiva dei conformi accessori come da elenco della documentazione tecnica di questa apparecchiatura, risponde alle direttive per Diagnostica In-Vitro 98/79/CE.

Geräteart / Type of device / Type d'appareil / Tipo di apparecchio:

**Laborzentrifuge / Laboratory centrifuge / Centrifugeuse de laboratoire / Centrifuga di laboratorio**

Typenbezeichnung / Type designation / Désignation du type / Denominazione del tipo:

**EBA 280 / EBA 280 S**

Das Konformitätsbewertungsverfahren wurde nach Anhang III der Richtlinie 98/79/EG durchgeführt.

The conformity evaluation process was performed in accordance with appendix III of Directive 98/79/EC.

La procédure d'évaluation de la conformité a été réalisée conformément à l'annexe III de la directive 98/79/CE.

La procedura di valutazione di conformità è stata eseguita conformemente all'appendice III delle direttive 98/79/CE.

Angewandte Normen und Richtlinien:

Gemäß Liste der angewandten Normen und mitgeltenden Richtlinien, die Teil der Produktakte ist.

Applied standards and directives:

According to the list of applied standards and valid directives which is part of the product documentation.

Normes et directives appliquées:

Conformément à la liste des normes et directives applicables et appliquées qui font partie du dossier relatif au produit.

Norme e direttive applicate:

Conformemente alla lista delle norme applicate e delle direttive di validità, che sono parte degli atti del prodotto.

Tuttlingen, 2014-10-27



H. Eberle  
Geschäftsführer, Manager,  
Directeur, Gerente



**Hettich**  
LAB TECHNOLOGY

## Für dieses Gerät gültige Normen und Vorschriften

Das Gerät ist ein Produkt mit einem sehr hohen technischen Niveau. Es unterliegt umfangreichen Prüf- und Zertifizierungsverfahren gemäß folgenden Normen und Vorschriften in deren jeweils gültigen Fassung:

### Elektrische und mechanische Sicherheit für Konstruktion und Endprüfung:

Normbaureihe: IEC 61010 (entspricht der Normenreihe DIN EN 61010)

- IEC 61010-1 "Sicherheitsbestimmungen für elektrische Mess-, Steuer-, Regel- und Laborgeräte - Teil 1: Allgemeine Anforderungen" (Verschmutzungsgrad 2, Installationskategorie II)
- IEC 61010-2-010 "Sicherheitsbestimmungen für elektrische Mess-, Steuer-, Regel- und Laborgeräte – Teil 2-010: Besondere Anforderungen an Laborgeräte für das Erhitzen von Stoffen (nur für Zentrifugen mit Heizung gültig)
- IEC 61010-2-020 "Sicherheitsbestimmungen für elektrische Mess-, Steuer-, Regel- und Laborgeräte - Teil 2-020: Besondere Anforderungen an Laborzentrifugen
- IEC 61010-2-101 "Sicherheitsbestimmungen für elektrische Mess-, Steuer-, Regel- und Laborgeräte - Teil 2-101: Besondere Anforderungen an In-vitro-Diagnostik (IVD) Medizingeräte

### Elektromagnetische Verträglichkeit:

- EN 61326-1 "Elektrische Mess-, Steuer-, Regel- und Laborgeräte - EMV-Anforderungen - Teil 1: Allgemeine Anforderungen

### Für Konformitätsbewertungsverfahren geltende Europäische Richtlinien:

- Richtlinie 98/79/EC über In-vitro-Diagnosegeräte  
EG-Konformitätsbewertungsverfahren gemäß Anhang III "EG-Konformitätserklärung" – Eigenerklärung des Herstellers

### Weitere, mitgeltende europäische Richtlinien:

- Maschinenrichtlinie 2006/42/EG
- EMV-Richtlinie 2004/108/EG
- Niederspannungsrichtlinie 2006/95/EC

### Außerhalb Europas geltende Richtlinien für Medizinprodukte:

- **USA:** QSR, 21CFR 820 "CFR Title 21 - Food and Drugs: TITLE 21- FOOD AND DRUGS, CHAPTER I - FOOD AND DRUG ADMINISTRATION DEPARTMENT OF HEALTH AND HUMAN SERVICES, SUBCHAPTER H - MEDICAL DEVICES, Part 820 QUALITY SYSTEM REGULATIONS"
- **Kanada:** CMDR, SOR/98-282 "Medical Devices Regulations"

### Zertifiziertes Qualitätsmanagementsystem gemäß

- ISO 9001 "Qualitätsmanagementsysteme - Anforderungen"
- ISO 13485 "Qualitätsmanagementsysteme für Medizinprodukte - Anforderungen für regulatorische Zwecke"

### Umweltmanagementsystem gemäß

- ISO 14001 "Umweltmanagementsysteme - Spezifikation mit Anleitung zur Anwendung"

---

## Standards and regulations which apply to this device

The device is a high-end technical product. It is subject to extensive testing and certification procedures according to the following standards and regulations in their respectively valid version:

### Electrical and mechanical safety for design and final testing:

Standard series: IEC 61010 (conform to standards of DIN EN 61010)

- IEC 61010-1 "Safety requirements for electrical equipment for measurement, control, and laboratory use - Part 1: General requirements" (Pollution Degree 2, Installation Category II)
- IEC 61010-2-010 "Safety requirements for electrical equipment for measurement, control and laboratory use - Part 2-010: Particular requirements for laboratory equipment for the heating of materials" (applied to heated centrifuges only)
- IEC 61010-2-020 "Safety requirements for electrical equipment for measurement, control, and laboratory use - Part 2-020: Particular requirements for laboratory centrifuges"
- IEC 61010-2-101 "Safety requirements for electrical equipment for measurement, control and laboratory use - Part 2-101: Particular requirements for in vitro diagnostic (IVD) medical equipment"

### Electromagnetic Compatibility:

- EN 61326-1 "Electrical equipment for measurement, control and laboratory use - EMC requirements - Part 1: General requirements"

### European directives applied for conformity assessment procedures:

- In vitro diagnostic device directive 98/79/EG  
EC conformity assessment procedure according to annex III "EC DECLARATION OF CONFORMITY" – self-declaration by the manufacturer

### Further partly applicable European directives:

- Machinery Directive 2006/42/EC
- EMC directive 2004/108/EC
- Low voltage directive 2006/95/EC

### Applied medical device regulations outside Europe:

- **USA:** QSR, 21CFR 820 "CFR Title 21 - Food and Drugs: TITLE 21- FOOD AND DRUGS, CHAPTER I - FOOD AND DRUG ADMINISTRATION DEPARTMENT OF HEALTH AND HUMAN SERVICES, SUBCHAPTER H - MEDICAL DEVICES, Part 820 QUALITY SYSTEM REGULATIONS"
- **Canada:** CMDR, SOR/98-282 "Medical Devices Regulations"

### Certified quality management system according to

- ISO 9001 "Quality management systems – Requirements"
- ISO13485 "Medical devices - Quality management systems - Requirements for regulatory purposes"

### Environmental management system according to

- ISO 14001 "Environmental management systems - Requirements with guidance for use"

## Normes et règles en vigueur pour cet appareil

Cet appareil est un produit avec un très haut niveau technique. Il est soumis à des vastes procédures de vérification et de certification, d'après les normes et prescriptions suivantes, dans leur version actuelle :

### Sécurité électrique et mécanique pour la construction et l'inspection finale :

Série de normes : IEC 61010 (correspond à la série de norme DIN EN 61010)

- IEC 61010-1 "Règles de sécurité pour appareils électriques de mesure, de régulation et de laboratoire - partie 1 : Prescriptions générales" (niveau de sécurité 2, catégorie d'installation II)
- IEC 61010-2-010 "Règles de sécurité pour appareils électriques de mesure, de régulation et de laboratoire – partie 2-010 : Prescriptions particulières pour appareils de laboratoire utilisés pour l'échauffement des matières (seulement valable pour centrifugeuses avec chauffage)
- IEC 61010-2-020 "Règles de sécurité pour appareils électriques de mesure, de régulation et de laboratoire – partie 2-020 : Prescriptions particulières pour centrifugeuses de laboratoire
- IEC 61010-2-101 "Règles de sécurité pour appareils électriques de mesure, de régulation et de laboratoire – partie 2-101 : Prescriptions particulières pour les appareils médicaux de diagnostic in vitro (DIV)

### Compatibilité électromagnétique :

- EN 61326-1 "Matériel électrique de mesure, de commande et de laboratoire – Exigences relatives à la CEM - partie 1 : Exigences générales

### Directives européennes valables pour des procédures d'évaluation de la conformité :

- directive 98/79/EC relative aux dispositifs médicaux de diagnostic in vitro  
procédure d'évaluation de la conformité CE d'après l'annexe III "Déclaration CE de conformité" –  
déclaration spécifique du fabricant

### Autres directives européennes partiellement valables :

- directive 2006/42/EG relative aux machines
- directive CEM 2004/108/EG
- directive basse tension 2006/95/EC

### Directives pour dispositifs médicaux, valables en dehors de l'Europe :

- **USA** : QSR, 21CFR 820 "CFR Title 21 - Food and Drugs : TITLE 21- FOOD AND DRUGS, CHAPTER I - FOOD AND DRUG ADMINISTRATION DEPARTMENT OF HEALTH AND HUMAN SERVICES, SUBCHAPTER H - MEDICAL DEVICES, Part 820 QUALITY SYSTEM REGULATIONS"
- **Canada**: CMDR, SOR/98-282 "Medical Devices Regulations"

### Système de management de la qualité certifié d'après

- ISO 9001 "Systèmes de management de la qualité - Prescriptions"
- ISO 13485 "Dispositifs médicaux - Systèmes de management de la qualité - Exigences à des fins réglementaires"

### Système de management environnemental d'après

- ISO 14001 "Systèmes de management environnemental - Spécification avec description pour application"

## Norme e direttive valide per questo apparecchio

L'apparecchio è un dispositivo di elevatissimo livello tecnico. È sottoposto a numerosi procedimenti di collaudo e certificazione, in conformità alle seguenti norme e direttive nella corrispondente versione di validità:

### **Sicurezza elettrica e meccanica per la costruzione ed il collaudo finale:**

Serie di norma: IEC 61010 (corrisponde alla serie di norma DIN EN 61010)

- IEC 61010-1 "Norme di sicurezza per apparecchiature elettriche di misurazione, di comando, di regolazione e di laboratorio - parte 1: Requisiti generali" (grado di imbrattamento 2, categoria di installazione II)
- IEC 61010-2 -010 "Norme di sicurezza per apparecchiature elettriche di misurazione, di comando, di regolazione e di laboratorio - parte 2-010: Requisiti particolari per le apparecchiature di laboratorio per il riscaldamento di materiali (valido solo per centrifughe con riscaldamento)
- IEC 61010-2 -020 "Norme di sicurezza per apparecchiature elettriche di misurazione, di comando, di regolazione e di laboratorio - parte 2-020: Requisiti particolari per centrifughe di laboratorio
- IEC 61010-2 -101 "Norme di sicurezza per apparecchiature elettriche di misurazione, di comando, di regolazione e di laboratorio - parte 2-101: Requisiti particolari per la diagnostica In-vitro (IVD) apparecchiature medicali

### **Compatibilità elettromagnetica:**

- EN 61326-1 "Apparecchiature elettriche di misurazione, di comando, di regolazione e di laboratorio - requisiti di compatibilità elettromagnetica - parte 1: Requisiti generali

### **Direttive europee che sono di validità per il procedimento di valutazione della conformità:**

- Direttive 98/79/CE per apparecchiature di diagnosi In-vitro  
Procedimento di valutazione di conformità CE conforme all'appendice III "Dichiarazione di conformità CE" – Dichiarazione propria del costruttore

### **Ulteriori direttive europee, che sono in parte di validità:**

- Direttive per macchine 2006/42/CE
- Direttive per compatibilità elettromagnetica 2004/108/CE
- Direttive per basse tensioni 2006/95/CE

### **Direttive valide al di fuori dell'ambito europeo per i prodotti medicali:**

- **USA:** QSR, 21CFR 820 "CFR Title 21 - Food and Drugs: TITLE 21- FOOD AND DRUGS, CHAPTER I - FOOD AND DRUG ADMINISTRATION DEPARTMENT OF HEALTH AND HUMAN SERVICES, SUBCHAPTER H - MEDICAL DEVICES, Part 820 QUALITY SYSTEM REGULATIONS"
- **Kanada:** CMDR, SOR/98-282 "Medical Devices Regulations"

### **Certificato sistema di gestione della qualità, conforme a**

- ISO 9001 "Requisiti per sistemi di gestione qualità"
- ISO13485 "Sistemi di gestione qualità per prodotti medicali - Requisiti per impieghi di regolazione"

### **Sistema di gestione ambientale, conforme a**

- ISO 14001 "Sistemi di gestione ambientale - Specificazione con istruzioni per l'applicazione"

**Inhaltsverzeichnis**

1	Anwendung dieser Bedienungsanleitung.....	10
2	Bedeutung der Symbole .....	10
3	Bestimmungsgemäße Verwendung.....	11
4	Restrisiken.....	11
5	Technische Daten.....	12
6	Sicherheitshinweise.....	13
7	Transport und Lagerung .....	14
7.1	Transport.....	14
7.2	Lagerung.....	14
8	Lieferumfang.....	14
9	Transportsicherung entfernen.....	15
10	Inbetriebnahme .....	15
11	Deckel öffnen und schließen .....	16
11.1	Deckel öffnen.....	16
11.2	Deckel schließen.....	16
12	Einsetzen und Herausnehmen des Rotors.....	17
13	Beladen des Rotors.....	18
14	Bedien- und Anzeigeelemente .....	19
14.1	Angezeigte Symbole .....	19
14.2	Tasten des Bedienfeldes .....	19
14.3	Einstellmöglichkeiten .....	20
15	Programmierung .....	21
15.1	Programme eingeben oder ändern.....	21
15.2	Programme abrufen .....	23
15.3	Programme speichern.....	23
16	Zentrifugation .....	24
16.1	Zentrifugation mit Zeitvorwahl.....	24
16.2	Dauerlauf .....	25
16.3	Kurzzeitzentrifugation .....	26
17	Not-Stopp.....	26
18	Rotorerkennung .....	27
19	Zyklenzähler.....	28
20	Einstellungen und Abfragen .....	29
20.1	System-Informationen abfragen.....	30
20.2	Akustisches Signal.....	31
20.3	Optisches Signal nach Beendigung des Zentrifugationslaufes .....	32
20.4	Automatisches Entriegeln des Deckels nach dem Zentrifugationslauf.....	33
20.5	Hintergrundbeleuchtung der Anzeige.....	34
20.6	Angezeigte Zentrifugations-Parameter nach dem Einschalten des Gerätes.....	35
20.7	Funktion "Dual time" aktivieren/deaktivieren .....	36
20.8	Die Betriebsstunden und die Anzahl der Zentrifugationsläufe abfragen .....	37
20.9	Zyklenzähler auf Null zurücksetzen .....	38
21	Relative Zentrifugalbeschleunigung (RCF).....	39



22	Zentrifugation von Stoffen oder Stoffgemischen mit einer höheren Dichte als $1,2 \text{ kg/dm}^3$ .....	39
23	Notentriegelung .....	39
24	Pflege und Wartung .....	40
24.1	Zentrifuge (Gehäuse, Deckel und Schleuderraum) .....	40
24.1.1	Oberflächenreinigung und -pflege .....	40
24.1.2	Oberflächendesinfektion .....	40
24.1.3	Entfernen radioaktiver Verunreinigungen .....	40
24.2	Rotoren und Zubehör .....	41
24.2.1	Reinigung und Pflege .....	41
24.2.2	Desinfektion .....	41
24.2.3	Entfernen radioaktiver Verunreinigungen .....	41
24.2.4	Rotoren und Zubehör mit begrenzter Verwendungsdauer .....	41
24.3	Autoklavieren .....	42
24.4	ZentrifugiergefäÙe .....	42
25	Störungen .....	43
26	Netzeingangssicherungen wechseln .....	44
27	Rücksendung von Geräten .....	45
28	Entsorgung .....	45
29	Anhang / Appendix .....	160
29.1	Rotoren und Zubehör / Rotors and accessories .....	160

## 1 Anwendung dieser Bedienungsanleitung

- Vor Benutzung der Zentrifuge ist die Bedienungsanleitung zu lesen und zu beachten.
- Die Bedienungsanleitung ist Teil des Gerätes. Sie muss stets griffbereit aufbewahrt werden.
- Wird das Gerät an einem anderen Ort aufgestellt, muss die Bedienungsanleitung mitgegeben werden.

## 2 Bedeutung der Symbole



Symbol am Gerät:

Achtung, allgemeine Gefahrenstelle.

Vor Benutzung des Gerätes unbedingt die Bedienungsanleitung lesen und die sicherheitsrelevanten Hinweise beachten!



Symbol in diesem Dokument:

Achtung, allgemeine Gefahrenstelle.

Dieses Symbol kennzeichnet sicherheitsrelevante Hinweise und deutet auf mögliche gefährliche Situationen hin.

Das Nichtbeachten dieser Hinweise kann zu Sach- und Personenschäden führen.



Symbol am Gerät und in diesem Dokument:

Warnung vor Biogefährdung.



Symbol in diesem Dokument:

Dieses Symbol deutet auf wichtige Sachverhalte hin.



Symbol am Gerät:

Das Symbol befindet sich am Gehäuse, in der Nähe des Scharniers.

Drehrichtung des Rotors.



Symbol am Gerät:

Das Symbol befindet sich vorne am Gehäuse, unterhalb der Bohrung.

Drehrichtung des Sechskant-Stiftschlüssels zur Notentriegelung des Deckels.



Symbol am Gerät und in diesem Dokument:

Symbol für die getrennte Sammlung von Elektro- und Elektronikgeräten, gemäß der Richtlinie 2002/96/EG (WEEE). Das Gerät gehört zur Gruppe 8 (Medizinische Geräte).

Verwendung in den Ländern der Europäischen Union sowie in Norwegen und der Schweiz.

### 3 Bestimmungsgemäße Verwendung

Bei dem vorliegenden Gerät handelt es sich um ein Medizinprodukt (Laborzentrifuge) im Sinne der IVD-Richtlinie 98/79/EG.

Die Zentrifuge dient zum Trennen von Stoffen bzw. Stoffgemischen mit einer Dichte von max. 1,2 kg/dm<sup>3</sup>, insbesondere von Proben zur Vorbereitung für die humanmedizinische In-vitro Diagnostik.

Darunter fällt speziell die Kaliumbestimmung im Blutserum. Das Laufverhalten bewirkt eine schonende Trennung und verhindert damit das Ansammeln von zusätzlichem erythrozytärem Kalium im Serum. Einer Verfälschung der Testergebnisse wird dadurch vorgebeugt.

Die Zentrifuge ist nur für diesen Verwendungszweck bestimmt.

Eine andere oder darüber hinausgehende Benutzung gilt als nicht bestimmungsgemäß. Für hieraus entstehende Schäden haftet die Firma Andreas Hettich GmbH & Co. KG nicht.

Zur bestimmungsgemäßen Verwendung gehört auch das Beachten aller Hinweise aus der Bedienungsanleitung und die Einhaltung der Inspektions- und Wartungsarbeiten.

Wird die Zentrifuge in ein anderes Gerät eingebaut oder in ein System integriert, so ist der Hersteller des Gesamtsystems für dessen Sicherheit verantwortlich.

### 4 Restrisiken

Das Gerät ist nach dem Stand der Technik und den anerkannten sicherheitstechnischen Regeln gebaut. Bei unsachgemäßer Verwendung und Behandlung können Gefahren für Leib und Leben des Benutzers oder Dritter bzw. Beeinträchtigungen an dem Gerät oder an anderen Sachwerten entstehen. Das Gerät ist nur für die bestimmungsgemäße Verwendung, und nur in sicherheitstechnisch einwandfreiem Zustand zu benutzen.

Störungen, die die Sicherheit beeinträchtigen können, sind umgehend zu beseitigen.

## 5 Technische Daten

Hersteller	Andreas Hettich GmbH & Co. KG D-78532 Tuttlingen			
Modell	EBA 280		EBA 280 S	
Typ	1101	1101-01	1102	1102-01
Netzspannung ( $\pm 10\%$ )	200 - 240 V 1~	100 - 127 V 1~	200 - 240 V 1~	100 - 127 V 1~
Netzfrequenz	50 - 60 Hz-	50 - 60 Hz	50 - 60 Hz-	50 - 60 Hz
Anschlusswert	185 VA	185 VA	330 VA	330 VA
Stromaufnahme	0.85 A	1.75 A	1.6 A	3.0 A
Kapazität max.	6 x 50 ml			
zulässige Dichte	1.2 kg/dm <sup>3</sup>			
Drehzahl (RPM)	6000			
Beschleunigung (RCF)	4146		5031	
Kinetische Energie	2700 Nm			
Prüfpflicht (BGR 500)	nein			
Umgebungsbedingungen (EN / IEC 61010-1)	<p>nur in Innenräumen bis zu 2000 m über Normal-Null 2°C bis 40°C maximale relative Luftfeuchte 80% für Temperaturen bis 31°C, linear abnehmend bis 50% relativer Luftfeuchte bei 40°C.</p>			
– Aufstellungsort				
– Höhe				
– Umgebungstemperatur				
– Luftfeuchtigkeit				
– Überspannungskategorie (IEC 60364-4-443)	II			
– Verschmutzungsgrad	2			
Geräteschutzklasse	I			
nicht für den Einsatz in explosionsgefährdeter Umgebung geeignet.				
EMV				
– Störaussendung, Störfestigkeit	EN / IEC 61326-1, Klasse B	FCC Class B	EN / IEC 61326-1, Klasse B	FCC Class B
Geräuschpegel (rotorabhängig)	$\leq 51$ dB(A)		$\leq 56$ dB(A)	
Abmessungen				
– Breite	326 mm			
– Tiefe	389 mm			
– Höhe	242 mm			
Gewicht	ca. 11 kg			

## 6 Sicherheitshinweise



**Werden nicht alle Hinweise in dieser Bedienungsanleitung befolgt, kann beim Hersteller kein Gewährleistungsanspruch geltend gemacht werden.**



- Die Zentrifuge ist so aufzustellen, dass sie standsicher betrieben werden kann.
- Vor Benutzung der Zentrifuge unbedingt überprüfen, dass der Rotor auf der Motorwelle eingerastet ist.
- Während eines Zentrifugationslaufes dürfen sich gemäß EN / IEC 61010-2-020, in einem Sicherheitsbereich von 300 mm um die Zentrifuge herum, keine Personen, Gefahrstoffe und Gegenstände befinden.
- Rotoren, Gehänge und Zubehörteile, die starke Korrosionsspuren oder mechanische Schäden aufweisen, oder deren Verwendungsdauer abgelaufen ist, dürfen nicht mehr verwendet werden.
- Die Zentrifuge darf nicht mehr in Betrieb genommen werden, wenn der Schleuderraum sicherheitsrelevante Schäden aufweist.
- Bei Zentrifugen ohne Temperaturregelung kann es bei erhöhter Raumtemperatur und/oder bei häufigem Gebrauch des Gerätes zur Erwärmung des Schleuderraums kommen. Eine temperaturbedingte Veränderung des Probenmaterials kann deshalb nicht ausgeschlossen werden.

- **Vor Inbetriebnahme der Zentrifuge ist die Bedienungsanleitung zu lesen und zu beachten. Nur Personen, die die Bedienungsanleitung gelesen und verstanden haben, dürfen das Gerät bedienen.**
- Neben der Bedienungsanleitung und den verbindlichen Regelungen der Unfallverhütung sind auch die anerkannten fachtechnischen Regeln für sicherheits- und fachgerechtes Arbeiten zu beachten. Die Bedienungsanleitung ist um Anweisungen aufgrund bestehender nationaler Vorschriften des Verwenderlandes zur Unfallverhütung und zum Umweltschutz zu ergänzen.
- Die Zentrifuge ist nach dem Stand der Technik gebaut und betriebssicher. Es können aber von ihr Gefahren für den Benutzer oder Dritte ausgehen, wenn sie nicht von geschultem Personal oder unsachgemäß oder zu nicht bestimmungsgemäßem Gebrauch eingesetzt wird.
- Die Zentrifuge darf während des Betriebs nicht bewegt oder angestoßen werden.
- Im Störfall bzw. bei der Notentriegelung nie in den sich drehenden Rotor greifen.
- Um Schäden durch Kondensat zu vermeiden, muss bei Wechsel von einem kalten in einen warmen Raum, die Zentrifuge entweder mindestens 3 Stunden im warmen Raum aufwärmen bevor sie an das Netz angeschlossen werden darf oder 30 Minuten im kalten Raum warmlaufen.
- Es dürfen nur die vom Hersteller für dieses Gerät zugelassenen Rotoren und das zugelassene Zubehör verwendet werden (siehe Kapitel "Anhang/Appendix, Rotoren und Zubehör/Rotors and accessories"). Bevor Zentrifugiergefäße verwendet werden, die nicht in Kapitel "Anhang/Appendix, Rotoren und Zubehör/Rotors and accessories" aufgeführt sind, hat sich der Benutzer beim Hersteller zu vergewissern, ob diese verwendet werden dürfen.
- Der Rotor der Zentrifuge darf nur entsprechend dem Kapitel "Beladen des Rotors" beladen werden.
- Bei der Zentrifugation mit maximaler Drehzahl darf die Dichte der Stoffe oder Stoffgemische  $1,2 \text{ kg/dm}^3$  nicht überschreiten.
- Zentrifugationen mit unzulässiger Unwucht sind nicht erlaubt.
- Die Zentrifuge darf nicht in explosionsgefährdeter Umgebung betrieben werden.
- Eine Zentrifugation mit:
  - brennbaren oder explosiven Materialien
  - Materialien, die chemisch mit hoher Energie miteinander reagieren ist verboten.

- Bei der Zentrifugation von gefährlichen Stoffen bzw. Stoffgemischen, die toxisch, radioaktiv oder mit pathogenen Mikroorganismen verseucht sind, sind durch den Benutzer geeignete Maßnahmen zu treffen. Es müssen grundsätzlich Zentrifugiergefäße mit speziellen Schraubverschlüssen für gefährliche Substanzen verwendet werden. Bei Materialien der Risikogruppe 3 und 4 ist zusätzlich zu den verschließbaren Zentrifugiergefäßen ein Bio-Sicherheitssystem zu verwenden (siehe Handbuch "Laboratory Biosafety Manual" der Weltgesundheitsorganisation). Für diese Zentrifuge sind keine Bio-Sicherheitssysteme erhältlich.
- Der Betrieb der Zentrifuge mit stark korrodierenden Stoffen, welche die mechanische Festigkeit von Rotoren, Gehäusen und Zubehöerteilen beeinträchtigen können, ist nicht erlaubt.
- Reparaturen dürfen nur von einer vom Hersteller autorisierten Person ausgeführt werden.
- Es dürfen nur Originalersatzteile und zugelassenes Originalzubehör der Firma Andreas Hettich GmbH & Co. KG verwendet werden.
- Es gelten die folgenden Sicherheitsbestimmungen:  
EN / IEC 61010-1 und EN / IEC 61010-2-020 sowie deren nationalen Abweichungen.
- Die Sicherheit und Zuverlässigkeit der Zentrifuge ist nur dann gewährleistet, wenn:
  - die Zentrifuge nach der Bedienungsanleitung betrieben wird.
  - die elektrische Installation, am Aufstellungsort der Zentrifuge, den Anforderungen von EN / IEC Festlegungen entspricht.
  - die in den jeweiligen Ländern vorgeschriebenen Prüfungen für die Sicherheit des Gerätes, z. B. in Deutschland nach BGV A1 und BGR 500, durch einen Sachkundigen durchgeführt werden.

## 7 Transport und Lagerung

### 7.1 Transport



Die Transportsicherung muss, vor dem Transport des Gerätes, eingebaut werden.

Beim Transport des Gerätes und des Zubehörs müssen folgende Umgebungsbedingungen eingehalten werden:

- Umgebungstemperatur:  $-20^{\circ}\text{C}$  bis  $+60^{\circ}\text{C}$
- Relative Luftfeuchtigkeit: 20% bis 80%, nicht kondensierend

### 7.2 Lagerung



Das Gerät und das Zubehör dürfen nur in geschlossenen und trockenen Räumen gelagert werden.

Bei der Lagerung des Gerätes und des Zubehörs müssen folgende Umgebungsbedingungen eingehalten werden:

- Umgebungstemperatur:  $-20^{\circ}\text{C}$  bis  $+60^{\circ}\text{C}$
- Relative Luftfeuchtigkeit: 20% bis 80%, nicht kondensierend

## 8 Lieferumfang

Folgendes Zubehör wird mit der Zentrifuge geliefert:

- 1 Anschlusskabel
- 2 Sicherungen
- 1 Sechskant-Stiftschlüssel
- 1 Bedienungsanleitung
- 1 Hinweisblatt Transportsicherung
- 1 Hinweisblatt Notentriegelung

Rotor(en) und das entsprechende Zubehör werden je nach Bestellung mitgeliefert.

## 9 Transportsicherung entfernen



Die Transportsicherung muss unbedingt entfernt werden.  
Die Transportsicherung aufbewahren, da sie vor dem Transport des Gerätes, wieder eingebaut werden muss.  
Das Gerät darf nur mit eingebauter Transportsicherung transportiert werden.

Um das Gerät während des Transports vor Beschädigungen zu schützen, wird der Motor fixiert. Diese Transportsicherung muss bei der Inbetriebnahme des Gerätes entfernt werden.

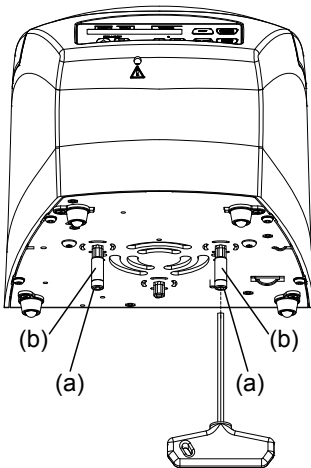

- Die beiden Schrauben (a) und Abstandshülsen (b) entfernen.



Der Einbau der Transportsicherung erfolgt in umgekehrter Reihenfolge.

## 10 Inbetriebnahme

- Die Transportsicherung am Gehäuseboden entfernen, siehe Kapitel "Transportsicherung entfernen".
- **Die Zentrifuge an einem geeigneten Platz standsicher aufstellen und nivellieren. Bei der Aufstellung ist der geforderte Sicherheitsbereich gemäß EN / IEC 61010-2-020, von 300 mm um die Zentrifuge herum, einzuhalten.**



**Während eines Zentrifugationslaufes dürfen sich gemäß EN / IEC 61010-2-020, in einem Sicherheitsbereich von 300 mm um die Zentrifuge herum, keine Personen, Gefahrstoffe und Gegenstände befinden.**

- Lüftungsöffnungen dürfen nicht zugestellt werden.  
Es muss ein Lüftungsabstand von 300 mm um die Lüftungsschlitze oder Lüftungsöffnungen eingehalten werden.
- Prüfen ob die Netzspannung mit der Angabe auf dem Typenschild übereinstimmt.
- Die Zentrifuge mit dem Anschlusskabel an eine genormte Netzsteckdose anschließen. Anschlusswert siehe Kapitel "Technische Daten".
- Den Netzschalter einschalten (Schalterstellung "I"). Die LED's leuchten kurzzeitig. Nacheinander erscheinen folgende Anzeigen:
  1. das Zentrifugen-Modell
  2. die Typ-Nummer und die Programmversion
  3. der Rotorcode (R) und die maximale Drehzahl des Rotors (maxRPM) des zuletzt durch die Rotorerkennung erkannten Rotors
  4. die Zentrifugations-Parameter des zuletzt benutzten Programms oder des Programms 1



Wenn der Deckel geschlossen ist, wird die Meldung "Open the lid" angezeigt.  
In diesem Fall den Deckel öffnen, damit die Zentrifugations-Parameter angezeigt werden.

## 11 Deckel öffnen und schließen

### 11.1 Deckel öffnen



Der Deckel lässt sich nur öffnen, wenn die Zentrifuge eingeschaltet ist und der Rotor stillsteht. Sollte dies nicht möglich sein, siehe Kapitel "Notentriegelung".



Wenn der Zyklenzähler aktiviert ist, wird nach einem Zentrifugationslauf, während dem Öffnen des Deckels, kurzzeitig die verbleibende Anzahl der Laufzyklen (Zentrifugationsläufe) angezeigt.

Beispiel:

PROG	RPM	t/min:s
RemCycles=	16703	



- Taste drücken.  
Der Deckel entriegelt motorisch.  
☑ : Deckel entriegelt.  
Die linke LED in der Taste erlischt.

Beispiel:

PROG	RPM	t/min:s
1 ☐	4500	5:00

### 11.2 Deckel schließen



Mit den Fingern nicht zwischen Deckel und Gehäuse greifen.  
Den Deckel nicht zuschlagen.

- Den Deckel auflegen und die Deckelvorderkante leicht niederdrücken.  
Der Deckel verriegelt motorisch.  
☑ : Deckel verriegelt.

Beispiel:

PROG	RPM	t/min:s
1 ☑	4500	5:00

Die linke LED in der Taste  leuchtet.



## 12 Einsetzen und Herausnehmen des Rotors

### Rotor mit Entriegelungsknopf

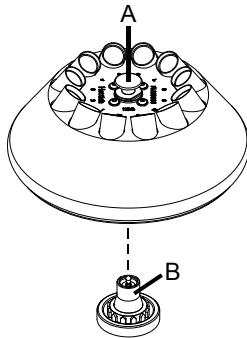

#### Einsetzen des Rotors:



Schmutzpartikel zwischen der Motorwelle und dem Rotor verhindern einen einwandfreien Sitz des Rotors und verursachen einen unruhigen Lauf. Bei Bedarf vor dem Einsetzen des Rotors die Motorwelle (B) und die Nabe des Rotors reinigen.

- Den Rotor am Entriegelungsknopf (A) anheben und waagrecht auf die Motorwelle (B) aufsetzen. Der Rotor rastet automatisch auf der Motorwelle ein.
- Den Rotor links und rechts festhalten und leicht nach oben ziehen, um zu prüfen, dass er auf der Motorwelle eingerastet ist.

#### Herausnehmen des Rotors:

- Den Entriegelungsknopf (A) am Rotor nach oben ziehen, festhalten und den Rotor von der Motorwelle abheben.

### Rotor ohne Entriegelungsknopf

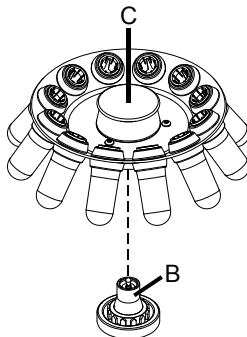

#### Einsetzen des Rotors:



Schmutzpartikel zwischen der Motorwelle und dem Rotor verhindern einen einwandfreien Sitz des Rotors und verursachen einen unruhigen Lauf. Bei Bedarf vor dem Einsetzen des Rotors die Motorwelle (B) und die Nabe des Rotors reinigen.

- Den Rotor am Griff (C) anheben, waagrecht auf die Motorwelle (B) aufsetzen und bis zum Anschlag nach unten drücken.

#### Herausnehmen des Rotors:

- Den Rotor am Griff (C) festhalten und von der Motorwelle abheben.

### 13 Beladen des Rotors



Standard-Zentrifugiergefäße aus Glas sind belastbar bis RZB 4000 (DIN 58970 Teil 2).

- Den Rotor links und rechts festhalten und leicht nach oben ziehen, um zu prüfen, dass er auf der Motorwelle eingerastet ist.  
Bei Ausschwingrotoren müssen alle Plätze des Rotors mit **gleichen** Gehängen besetzt sein.
- Die Rotoren und Gehänge dürfen nur symmetrisch beladen werden. Die Zentrifugiergefäße müssen gleichmäßig auf alle Plätze des Rotors verteilt werden. Zugelassene Kombinationen siehe Kapitel "Anhang/Appendix, Rotoren und Zubehör/Rotors and accessories".  
Bei Winkelrotoren müssen alle möglichen Plätze des Rotors beladen werden, siehe Kapitel "Anhang/Appendix, Rotoren und Zubehör/Rotors and accessories".

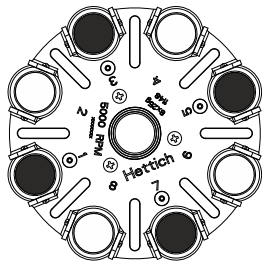

Rotor ist gleichmäßig beladen

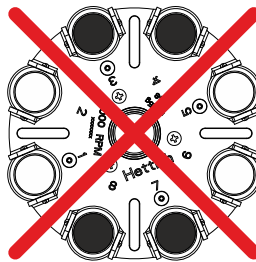

**Nicht zulässig!**  
Rotor ist ungleichmäßig beladen

- Bei Behältern mit Gummieinlagen muss sich unter den Zentrifugiergefäßen immer die gleiche Anzahl von Gummieinlagen befinden
- Die Zentrifugiergefäße dürfen nur außerhalb der Zentrifuge befüllt werden.
- Die vom Hersteller angegebene maximale Füllmenge der Zentrifugiergefäße darf nicht überschritten werden.

Bei Winkelrotoren dürfen die Zentrifugiergefäße nur soweit befüllt werden, dass während des Zentrifugationslaufes keine Flüssigkeit aus den Gefäßen herausgeschleudert werden kann.

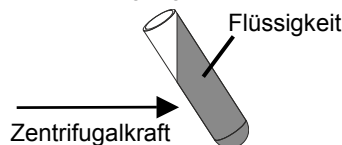

- Beim Beladen der Winkelrotoren darf keine Flüssigkeit in die Winkelrotoren und in den Schleuderraum gelangen.
- Beim Beladen der Gehänge der Ausschwingrotoren und beim Ausschwingen der Gehänge während des Zentrifugationslaufes darf keine Flüssigkeit in die Gehänge und in den Schleuderraum gelangen.
- Um die Gewichtsunterschiede innerhalb der Zentrifugiergefäße möglichst gering zu halten, ist auf eine gleichmäßige Füllhöhe in den Gefäßen zu achten.
- Auf jedem Rotor ist das Gewicht der zulässigen Füllmenge angegeben. Dieses Gewicht darf nicht überschritten werden.

## 14 Bedien- und Anzeigeelemente



### 14.1 Angezeigte Symbole



Deckel entriegelt.



Deckel verriegelt.



Rotationsanzeige. Die Rotationsanzeige leuchtet rotierend gegen den Uhrzeigersinn auf, solange sich der Rotor dreht.

### 14.2 Tasten des Bedienfeldes



- Programme abrufen
- Programme speichern.



- Umschalten zwischen RPM-Anzeige (RPM) und RCF-Anzeige (>RCF<). RCF-Werte werden in Klammern >< angezeigt. Die LED oberhalb der Taste leuchtet, wenn die RCF-Anzeige angewählt ist.  
RPM : Drehzahl  
RCF : Relative Zentrifugalbeschleunigung



- Wähltaste zum Anwählen der einzelnen Parameter. Durch jeden weiteren Tastendruck wird der nachfolgende Parameter angewählt.
- Das "MACHINE MENU" aufrufen (die Taste 8 Sekunden gedrückt halten).
- Im "Machine Menu" die Menüs "-> Info", "-> Settings" und "-> Time & Cycles" auswählen.
- In den Menüs vorwärts blättern.



- Wert eines zuvor angewählten Parameters verändern. Bei Gedrückthalten der Taste ändert sich der Wert mit zunehmender Geschwindigkeit.



- Den Zentrifugationslauf starten. Die LED in der Taste leuchtet während des Zentrifugationslaufes, solange sich der Rotor dreht.
- Kurzzeitzentrifugation. Der Zentrifugationslauf erfolgt, solange die Taste gedrückt gehalten wird. Die LED in der Taste leuchtet während des Zentrifugationslaufes, solange sich der Rotor dreht.
- Eingaben und Änderungen speichern.
- Die Menüs "-> Info", "-> Settings" und "-> Time & Cycles" aufrufen.



- Den Zentrifugationslauf beenden. Der Rotor läuft mit der vorgewählten Bremsstufe aus. Die rechte LED in der Taste leuchtet bis der Rotor stillsteht. Nach Stillstand des Rotors leuchtet die linke LED in der Taste. Zweimaliges Drücken der Taste löst den Not-Stopp aus.
- Den Deckel entriegeln. Die linke LED in der Taste erlischt.

### 14.3 Einstellmöglichkeiten

#### PROG RCL Programmplatz des abzurufenden Programms.

Die Programmplätze 1 bis 9 und # sind abrufbar.

**t/min** **Laufzeit.** Einstellbar von 1 - 99 min, in 1 Minuten-Schritten.

**t/sec** **Laufzeit.** Einstellbar von 1 - 59 s, in 1 Sekunden-Schritten.

**Dauerlauf "--:--".** Parameter **t/min** und **t/sec** auf Null stellen.

#### Begins at Zählung der Laufzeit.

**START** Die Laufzeit beginnt sofort nach Start des Zentrifugationslaufes zu zählen.

**Begins at** Die Laufzeit beginnt erst nach Erreichen der eingestellten Drehzahl zu zählen.  
**SPEED**

**Begins at** Die Laufzeit beginnt erst nach Erreichen der eingestellten Drehzahl zu zählen.  
**SPEED**

 Die Einstellung ist nur möglich, wenn die Funktion "Dual time" aktiviert ist, siehe Kapitel "Funktion "Dual time" aktivieren/deaktivieren". Die Funktion ist ab Werk aktiviert.

#### RPM Drehzahl

Einstellbar ist ein Zahlenwert von 200 RPM bis zur maximalen Drehzahl des Rotors.

Einstellbar in 10er Schritten.

Maximale Drehzahl des Rotors siehe Kapitel "Anhang/Appendix, Rotoren und Zubehör/Rotors and accessories".

#### RAD/mm Zentrifugerradius

Einstellbar von 10 mm bis 330 mm, in 1 Millimeter-Schritten.

Zentrifugerradius siehe Kapitel "Anhang/Appendix, Rotoren und Zubehör/Rotors and accessories".

 Die Eingabe des Zentrifugerradius ist nur möglich, wenn die RCF-Anzeige (➤RCF◄) angewählt ist.

#### RCF Relative Zentrifugalbeschleunigung

Einstellbar ist ein Zahlenwert, der eine Drehzahl zwischen 200 RPM und der maximalen Drehzahl des Rotors ergibt.

Einstellbar in 1er Schritten.

 Die Eingabe der relativen Zentrifugalbeschleunigung (RCF) ist nur möglich, wenn die RCF-Anzeige (➤RCF◄) angewählt ist.  
Die relative Zentrifugalbeschleunigung (RCF) ist vom Zentrifugerradius (RAD) abhängig.  
Es wird die relative Zentrifugalbeschleunigung (RCF) und der eingestellte Zentrifugerradius (RAD) angezeigt.



**Anlaufstufen 1 - 9.** Stufe 9 = kürzeste Anlaufzeit, Stufe 1 = längste Anlaufzeit.



**Bremsstufen 0 - 9.** Stufe 9 = kürzeste Auslaufzeit, Stufe 1 = lange Auslaufzeit, Stufe 0 = längste Auslaufzeit (ungebremster Auslauf).

#### PROG STO Programmplatz auf dem das Programm gespeichert wird.

Es können 9 Programme gespeichert werden (Programmplätze 1 bis 9).

 Auf dem Programmplatz # sollten keine Programme gespeichert werden.  
Der Programmplatz # dient als Zwischenspeicher, für geänderte Zentrifugations-Parameter.  
Die Zentrifugations-Parameter auf Programmplatz # werden jedesmal überschrieben, wenn ein Zentrifugationslauf mit geänderten Zentrifugations-Parametern durchgeführt wird, die nicht auf einem Programmplatz gespeichert wurden.

## 15 Programmierung



Auf dem Programmplatz # sollten keine Programme gespeichert werden.

Der Programmplatz # dient als Zwischenspeicher, für geänderte Zentrifugations-Parameter.

Werden Zentrifugations-Parameter geändert, anschließend aber nicht auf einem Programmplatz gespeichert, wird in der Anzeige anstelle der Programmplatz-Nummer ein Strich "-" angezeigt. Nach Start des Zentrifugationslaufes werden diese Zentrifugations-Parameter dann automatisch auf Programmplatz # gespeichert.

Die Zentrifugations-Parameter auf Programmplatz # werden jedesmal überschrieben, wenn ein Zentrifugationslauf mit geänderten Zentrifugations-Parametern durchgeführt wird, die nicht auf einem Programmplatz gespeichert wurden.

### 15.1 Programme eingeben oder ändern



Um den Dauerlauf einzustellen müssen die Parameter **t/min** und **t/sec** auf Null gestellt werden. In der Zeit-Anzeige (t/min:s) erscheint "--:--".

Beispiel:



Die relative Zentrifugalbeschleunigung (RCF) ist vom Zentrifugerradius (RAD) abhängig. Eine korrekte Berechnung ist nur möglich, wenn der richtige Zentrifugerradius eingestellt ist. Während der Eingabe der RCF wird der eingestellte Zentrifugerradius angezeigt.

Beispiel:



Die Anzeige und Eingabe der relativen Zentrifugalbeschleunigung (RCF) und des Zentrifugerradius (RAD) sind nur möglich, wenn die RCF-Anzeige (>RCF<) angewählt ist.

Wird nach der Anwahl oder während der Eingabe von Parametern 8 Sekunden lang keine Taste gedrückt, werden in der Anzeige wieder die vorherigen Werte angezeigt. Die Eingabe der Parameter muss dann erneut durchgeführt werden.

Die Eingabe der Parameter kann jederzeit durch Drücken der Taste  abgebrochen werden. In diesem Fall werden die Einstellungen nicht gespeichert.



- Die Taste drücken.  
**PROG RCL** : Programmplatz der angezeigten Zentrifugations-Parameter.



- Mit den Tasten den Programmplatz einstellen, dessen Zentrifugations-Parameter angezeigt werden sollen.



- Die Taste drücken.  
Die Zentrifugations-Parameter werden angezeigt.



Fortsetzung nächste Seite

#### Beispiel: RPM-Anzeige (RPM)





#### Beispiel: RCF-Anzeige (>RCF<)



	<ul style="list-style-type: none"> <li>Bei Bedarf die Taste drücken, um die RPM-Anzeige (RPM) oder die RCF-Anzeige (&gt;RCF&lt;) anzuwählen. Die LED oberhalb der Taste leuchtet, wenn die RCF-Anzeige (&gt;RCF&lt;) angewählt ist.</li> </ul>	<b>Beispiel: RPM-Anzeige (RPM)</b>	<b>Beispiel: RCF-Anzeige (&gt;RCF&lt;)</b>	
↓		<ul style="list-style-type: none"> <li>Die Taste so oft drücken bis der gewünschte Zentrifugations-Parameter angezeigt wird. Beispiel: <b>t/min</b> : Laufzeit, Minuten.</li> </ul>		
↓		<ul style="list-style-type: none"> <li>Mit den Tasten den gewünschten Wert einstellen.</li> </ul>		
↓		<ul style="list-style-type: none"> <li>Nacheinander alle gewünschten Zentrifugations-Parameter eingeben.</li> </ul>		
↓		<ul style="list-style-type: none"> <li>Nacheinander alle gewünschten Zentrifugations-Parameter eingeben.</li> </ul>		
↓		<ul style="list-style-type: none"> <li>Die Taste so oft drücken bis folgende Anzeige erscheint. <b>PROG STO</b> : Programmplatz auf dem die Zentrifugations-Parameter gespeichert werden.</li> </ul>		
↓		<ul style="list-style-type: none"> <li>Mit den Tasten den gewünschten Programmplatz einstellen.</li> </ul>		
↓		<ul style="list-style-type: none"> <li>Die Taste drücken. Die Zentrifugations-Parameter werden auf dem Programmplatz gespeichert.</li> </ul>		

## 15.2 Programme abrufen

- 
  - Die Taste drücken.  
**PROG RCL** : Programmplatz der angezeigten Zentrifugations-Parameter.
- ↓

  - Mit den Tasten den Programmplatz einstellen, dessen Zentrifugations-Parameter angezeigt werden sollen.
- ↓

  - Die Taste drücken.  
Die Zentrifugations-Parameter werden angezeigt.

### Beispiel: RPM-Anzeige (RPM)

PROG	>RCF<	RPM	t/min:s
PROG	RCL	=	2

PROG	>RCF<	RPM	t/min:s
PROG	RCL	=	1

PROG	>RCF<	RPM	t/min:s
*** OK ***			

PROG	>RCF<	RPM	t/min:s
1	a	4500	5:00

### Beispiel: RCF-Anzeige (>RCF<)

PROG	>RCF<	RPM	t/min:s
PROG	RCL	=	2

PROG	>RCF<	RPM	t/min:s
PROG	RCL	=	1

PROG	>RCF<	RPM	t/min:s
*** OK ***			

PROG	>RCF<	RPM	t/min:s
1	a>	2853<	5:00

## 15.3 Programme speichern

- 
  - Die Taste zweimal drücken.  
**PROG STO** : Programmplatz auf dem die Zentrifugations-Parameter gespeichert werden.
- ↓

  - Mit den Tasten den Programmplatz einstellen, auf dem die Zentrifugations-Parameter gespeichert werden sollen.
- ↓

  - Die Taste drücken.  
Die Zentrifugations-Parameter werden auf dem Programmplatz gespeichert.

### Beispiel: RPM-Anzeige (RPM)

PROG	>RCF<	RPM	t/min:s
PROG	STO	=	3

PROG	>RCF<	RPM	t/min:s
PROG	STO	=	1

PROG	>RCF<	RPM	t/min:s
*** OK ***			

PROG	>RCF<	RPM	t/min:s
1	a	4500	5:00

### Beispiel: RCF-Anzeige (>RCF<)

PROG	>RCF<	RPM	t/min:s
PROG	STO	=	3

PROG	>RCF<	RPM	t/min:s
PROG	STO	=	1

PROG	>RCF<	RPM	t/min:s
*** OK ***			

PROG	>RCF<	RPM	t/min:s
1	a>	2853<	5:00

## 16 Zentrifugation



Während eines Zentrifugationslaufes dürfen sich gemäß EN / IEC 61010-2-020, in einem Sicherheitsbereich von 300 mm um die Zentrifuge herum, keine Personen, Gefahrstoffe und Gegenstände befinden.



Nach jedem Zentrifugationslauf, während dem Entriegeln des Deckels, wird kurzzeitig die verbleibende Anzahl der Laufzyklen (Zentrifugationsläufe) angezeigt.

Beispiel:



Wurde der zulässige Gewichtsunterschied innerhalb der Beladung des Rotors überschritten, wird der Zentrifugationslauf während des Anlaufs abgebrochen und es erscheint folgende Anzeige:



Ein Zentrifugationslauf kann jederzeit durch Drücken der Taste  abgebrochen werden.

Während eines Zentrifugationslaufes können Zentrifugations-Parameter angewählt und geändert werden. Die geänderten Werte werden auf Programmplatz # gespeichert.

Mit der Taste  kann jederzeit zwischen der RPM-Anzeige (RPM) und der RCF-Anzeige (>RCF<) umgeschaltet werden. Wird mit der RCF-Anzeige (>RCF<) gearbeitet, ist die Eingabe des Zentrifugerradius notwendig.

Erscheint folgende Anzeige



so ist eine weitere Bedienung der Zentrifuge erst nach Öffnen des Deckels möglich.

Bedienfehler und Störungen werden angezeigt (siehe Kapitel "Störungen").

- Den Netzschalter einschalten. Schalterstellung I.
- Den Rotor beladen und den Zentrifugendeckel schließen.

### 16.1 Zentrifugation mit Zeitvorwahl



- Bei Bedarf die Taste drücken, um die RPM-Anzeige (RPM) oder die RCF-Anzeige (>RCF<) anzuwählen. Die LED oberhalb der Taste leuchtet, wenn die RCF-Anzeige (>RCF<) angewählt ist.



- Die gewünschten Zentrifugations-Parameter eingeben (siehe Kapitel "Programmierung").



- Die Taste drücken. Der Zentrifugationslauf wird gestartet. Während des Zentrifugationslaufes werden die Drehzahl des Rotors oder der daraus resultierende RCF-Wert, und die verbleibende Zeit angezeigt.



Fortsetzung nächste Seite

Beispiel:  
RPM-Anzeige (RPM)



Beispiel:  
RCF-Anzeige (>RCF<)





- Nach Ablauf der Zeit oder bei Abbruch des Zentrifugationslaufes durch Drücken der Taste , erfolgt der Auslauf mit der eingestellten Bremsstufe. Die Bremsstufe wird angezeigt. Beispiel  $\sim 7$

### 16.2 Dauerlauf



- Bei Bedarf die Taste drücken, um die RPM-Anzeige (RPM) oder die RCF-Anzeige (>RCF<) anzuwählen. Die LED oberhalb der Taste leuchtet, wenn die RCF-Anzeige (>RCF<) angewählt ist.



- Die gewünschten Zentrifugations-Parameter eingeben. Die Parameter *t/min* und *t/sec* auf Null stellen (siehe Kapitel "Programmierung").



- Die Taste drücken. Der Zentrifugationslauf wird gestartet. Während des Zentrifugationslaufes werden die Drehzahl des Rotors oder der daraus resultierende RCF-Wert, und die gelaufene Zeit angezeigt.



- Die Taste drücken. Der Zentrifugationslauf wird beendet. Der Auslauf erfolgt mit der eingestellten Bremsstufe. Die Bremsstufe wird angezeigt. Beispiel  $\sim 7$

Beispiel:  
RPM-Anzeige (RPM)



Beispiel:  
RCF-Anzeige (>RCF<)



Beispiel:  
RPM-Anzeige (RPM)



Beispiel:  
RCF-Anzeige (>RCF<)



## 16.3 Kurzzeitzentrifugation



- Bei Bedarf die Taste drücken, um die RPM-Anzeige (RPM) oder die RCF-Anzeige (>RCF<) anzuwählen. Die LED oberhalb der Taste leuchtet, wenn die RCF-Anzeige (>RCF<) angewählt ist.



- Die gewünschten Zentrifugations-Parameter eingeben (siehe Kapitel "Programmierung").



- Die Taste drücken und gedrückt halten. Während des Zentrifugationslaufes werden die Drehzahl des Rotors oder der daraus resultierende RCF-Wert, und die gelaufene Zeit angezeigt.



- Die Taste wieder loslassen. Der Zentrifugationslauf wird beendet. Der Auslauf erfolgt mit der eingestellten Bremsstufe. Die Bremsstufe wird angezeigt. Beispiel  $\sim 7$ .

### Beispiel: RPM-Anzeige (RPM)

PROG	>RCF<	RPM	t/min:s
1	▣	4500	5:00

PROG	>RCF<	RPM	t/min:s
1	▣	4000	5:00

PROG	>RCF<	RPM	t/min:s
1	▣	4000	0:24

PROG	>RCF<	RPM	t/min:s
1	▣	3980	$\sim 7$

### Beispiel: RCF-Anzeige (>RCF<)

PROG	>RCF<	RPM	t/min:s
1	>	2853<	5:00

PROG	>RCF<	RPM	t/min:s
1	>	2254<	5:00

PROG	>RCF<	RPM	t/min:s
1	>	2254<	0:24

PROG	>RCF<	RPM	t/min:s
1	>	2231<	$\sim 7$

## 17 Not-Stopp



- Die Taste zweimal drücken. Beim Not-Stopp erfolgt der Auslauf mit Bremsstufe 9 (kürzeste Auslaufzeit). Die Bremsstufe  $\sim 9$  wird angezeigt.

### Beispiel: RPM-Anzeige (RPM)

PROG	>RCF<	RPM	t/min:s
1	▣	4270	$\sim 9$

### Beispiel: RCF-Anzeige (>RCF<)

PROG	>RCF<	RPM	t/min:s
1	>	2568<	$\sim 9$

## 18 Rotorerkennung

Die Zentrifuge ist mit einer automatischen Rotorerkennung ausgestattet.

Nach Start eines jeden Zentrifugationslaufes wird eine Rotorerkennung durchgeführt.

Wenn der Rotorcode eines Rotors zum ersten Mal von der Rotorerkennung eingelesen wird, dann stoppt der Zentrifugationslauf nach der Rotorerkennung automatisch. Der Rotorcode (R) und die, für diese Zentrifuge zugelassene, maximale Drehzahl (maxRPM) des Rotors werden angezeigt.

Beispiel:



Nach Stillstand des Rotors (die linke LED in der Taste  leuchtet) muss eine beliebige Taste gedrückt werden. Danach wird die maximal zulässige Anzahl der Laufzyklen angezeigt.

Beispiel:



Nun muss die maximal zulässige Anzahl der Laufzyklen des Rotors bzw. der Gehänge eingestellt werden (siehe Kapitel "Zyklenzähler").

Bei Verwendung eines Rotors, dessen Rotorcode schon einmal von der Rotorerkennung eingelesen wurde, wird nach Start des Zentrifugationslaufes kurzzeitig die, für diese Zentrifuge zugelassene, maximale Drehzahl (ROTOR MAX) des Rotors angezeigt.

Beispiel:



Wenn die eingestellte Drehzahl größer als die, für diese Zentrifuge zugelassene, maximale Drehzahl des Rotors ist, wird der Zentrifugationslauf nach der Rotorerkennung abgebrochen, und es erscheinen im Wechsel folgende Anzeigen:

Beispiel:



In diesem Fall muss die Drehzahl in der Anzeige überprüft und an die maximale Drehzahl des Rotor angepasst werden.

## 19 Zyklenzähler



Die Verwendungsdauer von bestimmten Rotoren und Gehängen ist auf eine maximale Anzahl von Laufzyklen (Zentrifugationsläufe) begrenzt. Die betreffenden Rotoren und Gehänge sind mit der maximal zulässigen Anzahl der Laufzyklen gekennzeichnet.

Die Zentrifuge ist mit einem Zyklenzähler ausgestattet, der die Laufzyklen (Zentrifugationsläufe) der verschiedenen Rotorcodes zählt (siehe auch Kapitel "Rotorerkennung").

Nach jedem Zentrifugationslauf, während dem Entriegeln des Deckels, wird kurzzeitig die verbleibende Anzahl der Laufzyklen (Zentrifugationsläufe) angezeigt.

Beispiel:

PROG | >RCF< | RPM | U/min:s  
RemCycles= 16703

Ist die maximal zulässige Anzahl der Laufzyklen überschritten, erscheint nach jedem Start eines Zentrifugationslaufes folgende Anzeige und der Zentrifugationslauf muss erneut gestartet werden.

PROG | >RCF< | RPM | U/min:s  
Cycles passed



Erscheint die Anzeige

PROG | >RCF< | RPM | U/min:s  
Cycles passed

muss der betreffende Rotor bzw. die betreffenden Gehänge aus Sicherheitsgründen sofort gegen einen neuen Rotor bzw. neue Gehänge ausgetauscht werden.

Nachdem der Rotor bzw. die Gehänge ausgetauscht wurden, muss der Zyklenzähler des betreffenden Rotorcodes wieder auf Null zurückgesetzt werden (siehe Kapitel "Zyklenzähler auf Null zurücksetzen").

Wenn der Rotorcode eines Rotors zum ersten Mal von der Rotorerkennung eingelesen wird, dann stoppt der Zentrifugationslauf nach der Rotorerkennung automatisch. Der Rotorcode (R) und die, für diese Zentrifuge zugelassene, maximale Drehzahl (maxRPM) des Rotors werden angezeigt.

Anschließend muss die maximal zulässige Anzahl der Laufzyklen des Rotors bzw. der Gehänge eingestellt werden.



Bei Ausschwingrotoren muss immer die maximal zulässige Anzahl der Laufzyklen der Gehänge eingestellt werden.

Die maximal zulässige Anzahl der Laufzyklen des Rotors bzw. der Gehänge muss wie folgt eingestellt werden:

**Beispiel:**

Anzeige nach der Rotorerkennung.

**R** : Rotorcode des Rotors.

**maxRPM** : Die, für diese Zentrifuge zugelassene, maximale Drehzahl des Rotors.

PROG | >RCF< | RPM | U/min:s  
R 3 maxRPM 5000

Eine beliebige Taste drücken.

- Warten bis die linke LED in der Taste  leuchtet.

- Eine beliebige Taste drücken. Die maximal zulässige Anzahl der Laufzyklen wird angezeigt.

PROG | >RCF< | RPM | U/min:s  
Cyc lim=< 50000



Fortsetzung nächste Seite

**Beispiel:**

- Überprüfen, ob die angezeigte maximal zulässige Anzahl der Laufzyklen mit den Angaben auf dem Rotor bzw. den Gehängen übereinstimmt. Wenn nicht, muss die auf dem Rotor bzw. den Gehängen angegebene maximal zulässige Anzahl der Laufzyklen eingestellt werden.



- Bei Rotoren und Gehängen, deren Verwendungsdauer nicht auf eine maximale Anzahl von Laufzyklen (Zentrifugationsläufe) begrenzt ist, muss Null eingestellt werden.

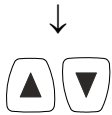

- Mit den Tasten den korrekten Wert einstellen.



- Die Taste drücken. Die maximal zulässige Anzahl der Laufzyklen wird gespeichert.



**20 Einstellungen und Abfragen**

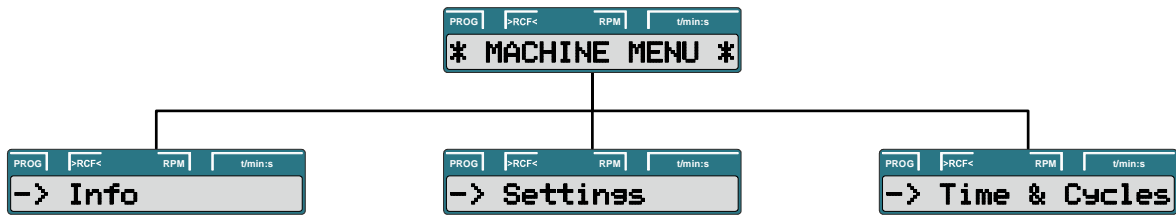

**Abfrage:**

- System-Informationen (Kapitel 20.1)

**Einstellung:**

- Akustisches Signal (Kapitel 20.2)
- Automatisches Entriegeln des Deckels nach dem Zentrifugationslauf (Kapitel 20.4)
- Automatische Abschaltung der Hintergrundbeleuchtung (Kapitel 20.5)
- Optisches Signal nach Beendigung des Zentrifugationslaufes (Kapitel 20.3)
- Angezeigte Zentrifugations-Parameter nach dem Einschalten des Gerätes (Kapitel 20.6)
- Funktion "Dual time" aktivieren/ deaktivieren (Kapitel 20.7)

**Abfrage:**

- Betriebsstunden (Kapitel 20.8)
- Anzahl der durchgeführten Zentrifugationsläufe (Kapitel 20.8)

**Einstellung:**

- Zyklenzähler (Kapitel 20.9)





















## 20.1 System-Informationen abfragen

Folgende System-Informationen können abgefragt werden:

- Zentrifugen-Modell,
- Die maximalen Drehzahlen der verschiedenen Rotorcodes,
- Programmversion der Zentrifuge,
- Typ des Frequenzumrichters,
- Programmversion des Frequenzumrichters

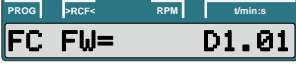
Die Abfrage kann, bei Stillstand des Rotors, wie folgt durchgeführt werden:

 Der Vorgang kann jederzeit durch Drücken der Taste  abgebrochen werden.

	• Die Taste 8 Sekunden gedrückt halten.		
↓			
	• Die Taste drücken.		
↓			
	• Die Taste drücken. Zentrifugen-Modell		
↓			
	• Die Taste drücken. <b>R</b> : Rotorcode des Rotors. <b>*</b> : Der Rotorcode des momentan verwendeten Rotors ist mit einem Stern gekennzeichnet. <b>RPMmax</b> : Die, für diese Zentrifuge zugelassene, maximale Drehzahl des Rotors.	Beispiel: 	
↓			
	• Mit den Tasten können die maximalen Drehzahlen der verschiedenen Rotorcodes angezeigt werden.	Beispiel: 	
↓			
	• Die Taste drücken. Programmversion der Zentrifuge.	Beispiel: 	
↓			
	• Die Taste drücken. Typ des Frequenzumrichters.	Beispiel: 	
↓			
	• Die Taste drücken. Programmversion des Frequenzumrichters.	Beispiel: 	
↓			
	• Die Taste zweimal drücken, um das Menü "-> Info" zu verlassen oder dreimal drücken, um das "* MACHINE MENU *" zu verlassen.	Beispiel: 	

## 20.2 Akustisches Signal

























Das akustische Signal ertönt:

- nach Auftreten einer Störung im 2 s-Intervall.
- nach Beendigung des Zentrifugationslaufes und Stillstand des Rotors im 30 s-Intervall.

Durch Drücken einer beliebigen Taste wird das akustische Signal beendet.

Das akustische Signal kann, bei Stillstand des Rotors, wie folgt eingestellt werden:

 Der Vorgang kann jederzeit durch Drücken der Taste  abgebrochen werden. In diesem Fall werden die Einstellungen nicht gespeichert.

	<ul style="list-style-type: none"> <li>• Die Taste 8 Sekunden gedrückt halten.</li> </ul>		
↓			
	<ul style="list-style-type: none"> <li>• Die Taste so oft drücken bis folgende Anzeige erscheint.</li> </ul>		
↓			
	<ul style="list-style-type: none"> <li>• Die Taste drücken. <b>End beep</b> : Akustisches Signal nach Beendigung des Zentrifugationslaufes. <b>off</b> : Signal deaktiviert. <b>on</b> : Signal aktiviert.</li> </ul>		
↓			
	<ul style="list-style-type: none"> <li>• Mit den Tasten <b>off</b> (aus) oder <b>on</b> (ein) einstellen.</li> </ul>		
↓			
	<ul style="list-style-type: none"> <li>• Die Taste drücken. <b>Error beep</b> : Akustisches Signal nach Auftreten einer Störung. <b>off</b> : Signal deaktiviert. <b>on</b> : Signal aktiviert.</li> </ul>		
↓			
	<ul style="list-style-type: none"> <li>• Mit den Tasten <b>off</b> (aus) oder <b>on</b> (ein) einstellen.</li> </ul>		
↓			
	<ul style="list-style-type: none"> <li>• Die Taste drücken. <b>Beep volume</b> : Lautstärke des akustischen Signals. <b>min</b> : leise <b>mid</b> : mittel <b>max</b> : laut</li> </ul>		
↓			
	<ul style="list-style-type: none"> <li>• Mit den Tasten <b>min</b>, <b>mid</b>, oder <b>max</b> einstellen.</li> </ul>		
↓			
			

Fortsetzung nächste Seite



- Die Taste drücken, um die Einstellung zu speichern.

PROG | >RCF< | RPM | U/min:s  
Store settings...

PROG | >RCF< | RPM | U/min:s  
-> Settings



- Die Taste einmal drücken, um das Menü "-> Settings" zu verlassen oder zweimal drücken, um das "\* MACHINE MENU \*" zu verlassen.

PROG | >RCF< | RPM | U/min:s  
\* MACHINE MENU \*

Beispiel:

PROG | >RCF< | RPM | U/min:s  
1 6 4500 5:00

### 20.3 Optisches Signal nach Beendigung des Zentrifugationslaufes

Die Hintergrundbeleuchtung der Anzeige blinkt nach dem Zentrifugationslauf, um optisch zu signalisieren, dass der Zentrifugationslauf beendet ist.

Das optische Signal kann, bei Stillstand des Rotors, wie folgt ein- oder ausgeschaltet werden:



Der Vorgang kann jederzeit durch Drücken der Taste  abgebrochen werden.



- Die Taste 8 Sekunden gedrückt halten.

PROG | >RCF< | RPM | U/min:s  
\* MACHINE MENU \*



- Die Taste so oft drücken bis folgende Anzeige erscheint.

PROG | >RCF< | RPM | U/min:s  
-> Settings



- Die Taste drücken.

PROG | >RCF< | RPM | U/min:s  
End beep =off

PROG | >RCF< | RPM | U/min:s  
End beep =on



- Die Taste so oft drücken bis eine der beiden Anzeigen erscheint.  
**End blinking** : Blinken der Hintergrundbeleuchtung der Anzeige nach dem Zentrifugationslauf.  
**off** : Hintergrundbeleuchtung blinkt nicht.  
**on** : Hintergrundbeleuchtung blinkt.

PROG | >RCF< | RPM | U/min:s  
End blinking=off

PROG | >RCF< | RPM | U/min:s  
End blinking=on



- Mit den Tasten **off** (aus) oder **on** (ein) einstellen.

PROG | >RCF< | RPM | U/min:s  
End blinking=off

PROG | >RCF< | RPM | U/min:s  
End blinking=on



- Die Taste drücken, um die Einstellung zu speichern.

PROG | >RCF< | RPM | U/min:s  
Store settings...

PROG | >RCF< | RPM | U/min:s  
-> Settings



- Die Taste einmal drücken, um das Menü "-> Settings" zu verlassen oder zweimal drücken, um das "\* MACHINE MENU \*" zu verlassen.

PROG | >RCF< | RPM | U/min:s  
\* MACHINE MENU \*

Beispiel:

PROG | >RCF< | RPM | U/min:s  
1 6 4500 5:00





















## 20.4 Automatisches Entriegeln des Deckels nach dem Zentrifugationslauf

Es kann eingestellt werden, ob der Deckel, nach dem Zentrifugationslauf, automatisch entriegelt oder nicht.

Bei Stillstand des Rotors kann dies wie folgt eingestellt werden:



 Der Vorgang kann jederzeit durch Drücken der Taste  abgebrochen werden. In diesem Fall werden die Einstellungen nicht gespeichert.



















	• Die Taste 8 Sekunden gedrückt halten.		
↓			
	• Die Taste so oft drücken bis folgende Anzeige erscheint.		
↓			
	• Die Taste drücken.		
↓			
	• Die Taste so oft drücken bis eine der beiden Anzeigen erscheint. <b>Lid AutoOpen</b> : Automatisches Entriegeln des Deckels nach dem Zentrifugationslauf. <b>off</b> : Deckel entriegelt nicht automatisch. <b>on</b> : Deckel entriegelt automatisch.		
↓			
	• Mit den Tasten <b>off</b> oder <b>on</b> einstellen.		
↓			
	• Die Taste drücken, um die Einstellung zu speichern.		
↓			
↓			
	• Die Taste einmal drücken, um das Menü " <b>-&gt; Settings</b> " zu verlassen oder zweimal drücken, um das " <b>* MACHINE MENU *</b> " zu verlassen.		Beispiel: 

## 20.5 Hintergrundbeleuchtung der Anzeige

Zum Einsparen von Energie kann eingestellt werden, dass nach einem Zentrifugationslauf, die Hintergrundbeleuchtung der Anzeige nach 2 Minuten ausschaltet.

Bei Stillstand des Rotors kann dies wie folgt eingestellt werden:



 Der Vorgang kann jederzeit durch Drücken der Taste  abgebrochen werden. In diesem Fall werden die Einstellungen nicht gespeichert.



















	<ul style="list-style-type: none"> <li>Die Taste 8 Sekunden gedrückt halten.</li> </ul>		
↓			
	<ul style="list-style-type: none"> <li>Die Taste so oft drücken bis folgende Anzeige erscheint.</li> </ul>		
↓			
	<ul style="list-style-type: none"> <li>Die Taste drücken.</li> </ul>		
↓			
	<ul style="list-style-type: none"> <li>Die Taste so oft drücken bis eine der beiden Anzeigen erscheint.  <b>Power save</b> : Automatische Abschaltung der Hintergrundbeleuchtung.  <b>off</b> : Automatische Abschaltung deaktiviert.  <b>on</b> : Automatische Abschaltung aktiviert.</li> </ul>		
↓			
	<ul style="list-style-type: none"> <li>Mit den Tasten <b>off</b> (aus) oder <b>on</b> (ein) einstellen.</li> </ul>		
↓			
	<ul style="list-style-type: none"> <li>Die Taste drücken, um die Einstellung zu speichern.</li> </ul>		
↓			
	<ul style="list-style-type: none"> <li>Die Taste einmal drücken, um das Menü "-&gt; Settings" zu verlassen oder zweimal drücken, um das "* MACHINE MENU *" zu verlassen.</li> </ul>		<p>Beispiel:</p> 

## 20.6 Angezeigte Zentrifugations-Parameter nach dem Einschalten des Gerätes

Es kann eingestellt werden, ob nach dem Einschalten des Gerätes die Zentrifugations-Parameter des zuletzt benutzten Programms oder des Programms 1 angezeigt werden.

Bei Stillstand des Rotors kann dies wie folgt eingestellt werden:



 Der Vorgang kann jederzeit durch Drücken der Taste  abgebrochen werden. In diesem Fall werden die Einstellungen nicht gespeichert.



















	<ul style="list-style-type: none"> <li>Die Taste 8 Sekunden gedrückt halten.</li> </ul>		
↓			
	<ul style="list-style-type: none"> <li>Die Taste so oft drücken bis folgende Anzeige erscheint.</li> </ul>		
↓			
	<ul style="list-style-type: none"> <li>Die Taste drücken.</li> </ul>		
↓			
	<ul style="list-style-type: none"> <li>Die Taste so oft drücken bis eine der beiden Anzeigen erscheint.  <b>Start Pr</b> : Angezeigtes Programm nach dem Einschalten.  <b>First</b> : Programm 1.  <b>Last</b> : zuletzt benutztes Programm.</li> </ul>		
↓			
	<ul style="list-style-type: none"> <li>Mit den Tasten <b>First</b> oder <b>Last</b> einstellen.</li> </ul>		
↓			
	<ul style="list-style-type: none"> <li>Die Taste drücken, um die Einstellung zu speichern.</li> </ul>		
			
↓			
	<ul style="list-style-type: none"> <li>Die Taste einmal drücken, um das Menü <b>"-&gt; Settings"</b> zu verlassen oder zweimal drücken, um das <b>"* MACHINE MENU *</b> zu verlassen.</li> </ul>		<p>Beispiel:</p> 

## 20.7 Funktion "Dual time" aktivieren/deaktivieren

Um die Zählung der Laufzeit (Parameter **Begins at START** und Parameter **Begins at SPEED**) einstellen zu können, muss die Funktion "Dual time" aktiviert sein. Die Funktion ist ab Werk aktiviert.

Bei Stillstand des Rotors kann dies wie folgt eingestellt werden:

 Der Vorgang kann jederzeit durch Drücken der Taste  abgebrochen werden. In diesem Fall werden die Einstellungen nicht gespeichert.

	<ul style="list-style-type: none"> <li>Die Taste 8 Sekunden gedrückt halten.</li> </ul>		
↓			
	<ul style="list-style-type: none"> <li>Die Taste so oft drücken bis folgende Anzeige erscheint.</li> </ul>		
↓			
	<ul style="list-style-type: none"> <li>Die Taste drücken.</li> </ul>		
↓			
	<ul style="list-style-type: none"> <li>Die Taste so oft drücken bis eine der beiden Anzeigen erscheint. <b>Dual time</b> : Zählung der Laufzeit. <b>on</b> : Funktion aktiviert. <b>off</b> : Funktion deaktiviert.</li> </ul>		
↓			
	<ul style="list-style-type: none"> <li>Mit den Tasten <b>off</b> (aus) oder <b>on</b> (ein) einstellen.</li> </ul>		
↓			
	<ul style="list-style-type: none"> <li>Die Taste drücken, um die Einstellung zu speichern.</li> </ul>		
↓			
	<ul style="list-style-type: none"> <li>Die Taste einmal drücken, um das Menü "-&gt; Settings" zu verlassen oder zweimal drücken, um das "* MACHINE MENU *" zu verlassen.</li> </ul>		<p>Beispiel:</p> 

## 20.8 Die Betriebsstunden und die Anzahl der Zentrifugationsläufe abfragen

Die Betriebsstunden sind in interne und externe Betriebsstunden aufgeteilt.

Interne Betriebsstunden: Gesamte Zeit, die das Gerät eingeschaltet war.

Externe Betriebsstunden: Gesamte Zeit der bisherigen Zentrifugationsläufe.

Die Abfrage kann, bei Stillstand des Rotors, wie folgt durchgeführt werden:

 Der Vorgang kann jederzeit durch Drücken der Taste  abgebrochen werden.



- Die Taste 8 Sekunden gedrückt halten.

```

PROG | PRCF< | RPM | t/min:s
* MACHINE MENU *
  
```



- Die Taste so oft drücken bis folgende Anzeige erscheint.

```

PROG | PRCF< | RPM | t/min:s
-> Time & Cycles
  
```



- Die Taste drücken.  
**TimeExt** : Externe Betriebsstunden.

Beispiel:

```

PROG | PRCF< | RPM | t/min:s
TimeExt= 1543 h
  
```



- Die Taste drücken.  
**TimeInt** : Interne Betriebsstunden.

Beispiel:

```

PROG | PRCF< | RPM | t/min:s
TimeInt= 1760 h
  
```



- Die Taste drücken.  
**Starts** : Anzahl aller Zentrifugationsläufe.

Beispiel:

```

PROG | PRCF< | RPM | t/min:s
Starts = 8325
  
```



- Die Taste zweimal drücken, um das Menü "-> Time & Cycles" zu verlassen oder dreimal drücken, um das "\* MACHINE MENU \*" zu verlassen.

```

PROG | PRCF< | RPM | t/min:s
* MACHINE MENU *
  
```

Beispiel:

```

PROG | PRCF< | RPM | t/min:s
1 4 4500 5:00
  
```

## 20.9 Zyklenzähler auf Null zurücksetzen

Nachdem der Rotor bzw. die Gehänge ausgetauscht wurden, muss der Zyklenzähler des betreffenden Rotorcodes wieder auf Null zurückgesetzt werden.

 Der Zyklenzähler darf nur auf Null zurückgesetzt werden, wenn zuvor der Rotor bzw. die Gehänge gegen einen neuen Rotor bzw. neue Gehänge ausgetauscht wurde.

Der Zyklenzähler kann, bei Stillstand des Rotors, wie folgt zurückgesetzt werden:

 Der Vorgang kann jederzeit durch Drücken der Taste  abgebrochen werden. In diesem Fall werden die Einstellungen nicht gespeichert.



- Die Taste 8 Sekunden gedrückt halten.

PROG | >RCF< | RPM | t/min:s  
\* MACHINE MENU \*



- Die Taste so oft drücken bis folgende Anzeige erscheint.

PROG | >RCF< | RPM | t/min:s  
-> Time & Cycles



- Die Taste drücken.

Beispiel:  
PROG | >RCF< | RPM | t/min:s  
TimeExt= 1543 h



- Die Taste so oft drücken bis folgende Anzeige erscheint.  
**Cyc sum** : Anzahl der durchgeführten Laufzyklen.

PROG | >RCF< | RPM | t/min:s  
Cyc sum= 50001



- Die Taste drücken.

PROG | >RCF< | RPM | t/min:s  
Cyc sum=< 50001 >



- Die Taste drücken.  
Die Anzahl der durchgeführten Laufzyklen wird auf Null zurückgesetzt.

PROG | >RCF< | RPM | t/min:s  
Cyc sum=< 0 >



- Die Taste drücken, um die Einstellung zu speichern.

PROG | >RCF< | RPM | t/min:s  
Store cycles ...

PROG | >RCF< | RPM | t/min:s  
Cyc sum= 0



- Die Taste zweimal drücken, um das Menü "-> Time & Cycles" zu verlassen oder dreimal drücken, um das "\* MACHINE MENU \*" zu verlassen.

PROG | >RCF< | RPM | t/min:s  
\* MACHINE MENU \*

Beispiel:

PROG | >RCF< | RPM | t/min:s  
1 6 4500 5:00

## 21 Relative Zentrifugalbeschleunigung (RCF)

Die relative Zentrifugalbeschleunigung (RCF) wird als Vielfaches der Erdbeschleunigung (g) angegeben. Sie ist ein einheitsfreier Zahlenwert und dient zum Vergleich der Trenn- und Sedimentationsleistung.

Die Berechnung erfolgt nach der Formel:

$$\text{RCF} = \left( \frac{\text{RPM}}{1000} \right)^2 \times r \times 1,118 \quad \Rightarrow \quad \text{RPM} = \sqrt{\frac{\text{RCF}}{r \times 1,118}} \times 1000$$

RCF = Relative Zentrifugalbeschleunigung

RPM = Drehzahl

r = Zentrifugerradius in mm = Abstand von der Mitte der Drehachse bis zum Zentrifugiergefäßboden.  
Zentrifugerradius siehe Kapitel "Anhang/Appendix, Rotoren und Zubehör/  
Rotors and accessories".



Die relative Zentrifugalbeschleunigung (RCF) ist von der Drehzahl und dem Zentrifugerradius abhängig.

## 22 Zentrifugation von Stoffen oder Stoffgemischen mit einer höheren Dichte als 1,2 kg/dm<sup>3</sup>

Bei der Zentrifugation mit maximaler Drehzahl darf die Dichte der Stoffe oder Stoffgemische 1,2 kg/dm<sup>3</sup> nicht überschreiten.

Bei Stoffen oder Stoffgemischen mit einer höheren Dichte muss die Drehzahl reduziert werden.

Die erlaubte Drehzahl lässt sich nach folgender Formel berechnen:

$$\text{Reduzierte Drehzahl (n}_{\text{red}}) = \sqrt{\frac{1,2}{\text{höhere Dichte [kg/dm}^3]}} \times \text{maximale Drehzahl [RPM]}$$

z.B.: Maximale Drehzahl 4000 RPM, Dichte 1,6 kg/dm<sup>3</sup>

$$n_{\text{red}} = \sqrt{\frac{1,2 \text{ kg/dm}^3}{1,6 \text{ kg/dm}^3}} \times 4000 \text{ RPM} = 3464 \text{ RPM}$$

Bei eventuellen Unklarheiten ist Auskunft beim Hersteller einzuholen.

## 23 Notentriegelung

Bei einem Stromausfall kann der Deckel nicht motorisch entriegelt werden. Es muss eine Notentriegelung von Hand durchgeführt werden.



Zur Notentriegelung die Zentrifuge vom Netz trennen.  
Den Deckel nur bei Stillstand des Rotors öffnen.



VORSICHT! Beschädigung des Verschlusses, während der Notentriegelung, durch Drehen des Sechskant-Stiftschlüssels im Uhrzeigersinn (nach rechts).  
Der Sechskant-Stiftschlüssel darf nur entgegen dem Uhrzeigersinn (nach links) gedreht werden, siehe Abbildung.

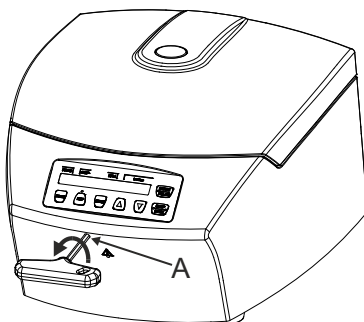

- Den Netzschalter ausschalten (Schalterstellung "0").
- Durch das Fenster im Deckel schauen, um sich zu vergewissern, dass der Rotor stillsteht.
- Den Sechskant-Stiftschlüssel waagrecht in die Bohrung (A) einführen und solange vorsichtig entgegen dem Uhrzeigersinn (nach links) drehen, bis der Deckel öffnet.
- Den Sechskant-Stiftschlüssel wieder aus der Bohrung herausziehen.

## 24 Pflege und Wartung



Das Gerät kann kontaminiert sein.



Vor der Reinigung den Netzstecker ziehen.

Bevor ein anderes als das vom Hersteller empfohlene Reinigungs- oder Dekontaminationsverfahren angewandt wird, hat sich der Benutzer beim Hersteller zu vergewissern, dass das vorgesehene Verfahren das Gerät nicht schädigt.

- Zentrifugen, Rotoren und das Zubehör dürfen nicht in Spülmaschinen gereinigt werden.
- Es darf nur eine Handreinigung und eine Flüssig-Desinfektion durchgeführt werden.
- Die Wassertemperatur muss 20 – 25°C betragen.
- Es dürfen nur Reinigungs- oder Desinfektionsmittel verwendet werden, die:
  - im pH-Bereich 5 - 8 liegen,
  - keine Ätzalkalien, Peroxide, Chlorverbindungen, Säuren und Laugen enthalten.
- Um Korrosionserscheinungen durch Reinigungs- oder Desinfektionsmittel zu vermeiden sind die speziellen Anwendungshinweise vom Hersteller des Reinigungs- oder Desinfektionsmittels unbedingt zu beachten.

### 24.1 Zentrifuge (Gehäuse, Deckel und Schleuderraum)

#### 24.1.1 Oberflächenreinigung und -pflege

- Das Gehäuse der Zentrifuge und den Schleuderraum regelmäßig säubern und bei Bedarf mit Seife oder einem milden Reinigungsmittel und einem feuchten Tuch reinigen. Dies dient zum einen der Hygiene und es verhindert Korrosion durch anhaftende Verunreinigungen.
- Inhaltsstoffe geeigneter Reinigungsmittel:  
Seife, anionische Tenside, nichtionische Tenside.
- Nach dem Einsatz von Reinigungsmitteln, die Reste des Reinigungsmittels, durch Nachwischen mit einem feuchten Tuch, entfernen.
- Die Flächen müssen unmittelbar nach der Reinigung getrocknet werden.
- Bei Bildung von Kondenswasser den Schleuderraum, durch Auswischen mit einem saugfähigen Tuch, trocknen.
- Die Gummidichtung des Schleuderraums nach jeder Reinigung mit Talkum-Puder oder einem Gummi-Pflegemittel leicht einreiben.
- Der Schleuderraum ist jährlich auf Schäden zu überprüfen.



Werden sicherheitsrelevante Schäden festgestellt, darf die Zentrifuge nicht mehr in Betrieb genommen werden. In diesem Fall ist der Kundendienst zu benachrichtigen.

#### 24.1.2 Oberflächendesinfektion

- Gelangt infektiöses Material in den Schleuderraum, so ist dieser umgehend zu desinfizieren.
- Inhaltsstoffe geeigneter Desinfektionsmittel:  
Äthanol, n-Propanol, Ethylhexanol, anionische Tenside, Korrosionsinhibitoren.
- Nach dem Einsatz von Desinfektionsmitteln, die Reste des Desinfektionsmittels, durch Nachwischen mit einem feuchten Tuch, entfernen.
- Die Flächen müssen unmittelbar nach der Desinfektion getrocknet werden.

#### 24.1.3 Entfernen radioaktiver Verunreinigungen

- Das Mittel muss speziell für das Entfernen radioaktiver Verunreinigungen ausgewiesen sein.
- Inhaltsstoffe geeigneter Mittel für das Entfernen radioaktiver Verunreinigungen:  
Anionische Tenside, nichtionische Tenside, polyhydrierter Äthanol.
- Nach dem Entfernen der radioaktiven Verunreinigungen, die Reste des Mittels, durch Nachwischen mit einem feuchten Tuch, entfernen.
- Die Flächen müssen unmittelbar nach dem Entfernen der radioaktiven Verunreinigungen getrocknet werden.



## 24.2 Rotoren und Zubehör

### 24.2.1 Reinigung und Pflege

- Um einer Korrosion und Materialveränderungen vorzubeugen müssen die Rotoren und das Zubehör regelmäßig mit Seife oder einem milden Reinigungsmittel und einem feuchten Tuch gereinigt werden. Die Reinigung wird mindestens einmal wöchentlich empfohlen. Verschmutzungen müssen sofort entfernt werden.
- Inhaltsstoffe geeigneter Reinigungsmittel:  
Seife, anionische Tenside, nichtionische Tenside.
- Nach dem Einsatz von Reinigungsmitteln, die Reste des Reinigungsmittels, durch Nachspülen mit Wasser (nur außerhalb der Zentrifuge) oder Nachwischen mit einem feuchten Tuch, entfernen.
- Die Rotoren und das Zubehör müssen unmittelbar nach der Reinigung getrocknet werden.
- Winkelrotoren, Behälter und Gehänge aus Aluminium sind nach dem Trocknen mit säurefreiem Fett z.B. Vaseline leicht einzufetten.
- Die Rotoren und das Zubehör sind wöchentlich auf Verschleiß und Korrosionsschäden zu überprüfen.



Rotoren und Zubehör dürfen bei Anzeichen von Verschleiß oder Korrosion nicht mehr verwendet werden.

### 24.2.2 Desinfektion

- Gelangt infektiöses Material auf die Rotoren oder auf das Zubehör, so muss eine geeignete Desinfektion durchgeführt werden.
- Inhaltsstoffe geeigneter Desinfektionsmittel:  
Äthanol, n-Propanol, Ethylhexanol, anionische Tenside, Korrosionsinhibitoren.
- Nach dem Einsatz von Desinfektionsmitteln, die Reste des Desinfektionsmittels, durch Nachspülen mit Wasser (nur außerhalb der Zentrifuge) oder Nachwischen mit einem feuchten Tuch, entfernen.
- Die Rotoren und das Zubehör müssen unmittelbar nach der Desinfektion getrocknet werden.

### 24.2.3 Entfernen radioaktiver Verunreinigungen

- Das Mittel muss speziell für das Entfernen radioaktiver Verunreinigungen ausgewiesen sein.
- Inhaltsstoffe geeigneter Mittel für das Entfernen radioaktiver Verunreinigungen:  
Anionische Tenside, nichtionische Tenside, polyhydrierter Äthanol.
- Nach dem Entfernen der radioaktiven Verunreinigungen, die Reste des Mittels, durch Nachspülen mit Wasser (nur außerhalb der Zentrifuge) oder Nachwischen mit einem feuchten Tuch, entfernen.
- Die Rotoren und das Zubehör müssen unmittelbar nach dem Entfernen der radioaktiven Verunreinigungen getrocknet werden.

### 24.2.4 Rotoren und Zubehör mit begrenzter Verwendungsdauer

Die Verwendung von bestimmten Rotoren, Gehängen und Zubehörteilen ist zeitlich begrenzt.

Diese sind mit der maximal erlaubten Anzahl der Laufzyklen oder dem Ablaufdatum und der maximalen Anzahl der Laufzyklen oder nur mit dem Ablaufdatum gekennzeichnet, z.B.:

- "usable until end of month/year: 10/2024" (einsetzbar bis Ende Monat/Jahr: 10/2024)
- "max. cycles: 40000" (max. Laufzyklen: 40000)



Aus Sicherheitsgründen dürfen die Rotoren, Gehänge und Zubehörteile nicht mehr verwendet werden, wenn entweder die darauf gekennzeichnete maximal erlaubte Anzahl der Laufzyklen oder das darauf gekennzeichnete Ablaufdatum erreicht ist.

Die Zentrifuge ist mit einem Zyklenzähler ausgestattet, der die Laufzyklen (Zentrifugationsläufe) der verschiedenen Rotorcodes zählt. Beschreibung siehe Kapitel "Zyklenzähler".

### 24.3 Autoklavieren

Das folgende Zubehör darf bei 121°C / 250°F (20 min) autoklaviert werden:

- Ausschwingrotoren ohne Gehänge
- Reduzierungen

Über den Sterilitätsgrad kann keine Aussage gemacht werden.



Das Autoklavieren beschleunigt den Alterungsprozess von Kunststoffen. Außerdem kann es bei Kunststoffen Farbveränderungen verursachen

### 24.4 Zentrifugiergefäße

- Bei Undichtigkeit oder nach dem Bruch von Zentrifugiergefäßen, sind zerbrochene Gefäßteile, Glassplitter und ausgelaufenes Zentrifugiergut vollständig zu entfernen.
- Die Gummieinlagen sowie die Kunststoff-Hülsen der Rotoren sind nach einem Glasbruch zu ersetzen.



Verbleibende Glassplitter verursachen weiteren Glasbruch !

- Handelt es sich um infektiöses Material so ist umgehend eine Desinfektion durchzuführen.

## 25 Störungen

Lässt sich der Fehler laut Störungstabelle nicht beheben, so ist der Kundendienst zu benachrichtigen.

Bitte den Zentrifugentyp und die Seriennummer angeben. Beide Nummern sind auf dem Typenschild der Zentrifuge ersichtlich.



Einen NETZ-RESET durchführen:

- Den Netzschalter ausschalten (Schalterstellung "0").
- Mindestens 10 Sekunden lang warten und anschließend den Netzschalter wieder einschalten (Schalterstellung "I").

Anzeige		Ursache	Beseitigung
keine Anzeige		keine Spannung. Netzeingangssicherungen defekt.	<ul style="list-style-type: none"> <li>- Versorgungsspannung überprüfen.</li> <li>- Netzeingangssicherungen überprüfen, siehe Kapitel "Netzeingangssicherungen wechseln".</li> <li>- Netzschalter EIN.</li> </ul>
IMBALANCE		Der Rotor ist ungleichmäßig beladen.	<ul style="list-style-type: none"> <li>- Nach Stillstand des Rotors den Deckel öffnen.</li> <li>- Die Beladung des Rotors überprüfen, siehe Kapitel "Beladen des Rotors".</li> <li>- Den Zentrifugationslauf wiederholen.</li> </ul>
RPM > ROTOR MAX		Drehzahl im angewählten Programm größer als die maximale Drehzahl des Rotors.	<ul style="list-style-type: none"> <li>- Drehzahl überprüfen und korrigieren.</li> </ul>
MAINS INTERRUPT		Netzunterbrechung während des Zentrifugationslaufes. (Der Zentrifugationslauf wurde nicht beendet.)	<ul style="list-style-type: none"> <li>- Nach Stillstand des Rotors den Deckel öffnen.</li> <li>- Taste  drücken.</li> <li>- Bei Bedarf den Zentrifugationslauf wiederholen.</li> </ul>
Rxxx WRONG ROTOR (xxx = Anzeige des Rotorcodes)		Der verwendete Rotor ist nicht für dieses Gerät zugelassen.	<ul style="list-style-type: none"> <li>- Einen Rotor einsetzen, der für dieses Gerät zugelassen ist.</li> </ul>
KEYBOARD ERROR		Fehler / Defekt Elektronik	<ul style="list-style-type: none"> <li>- Nach Stillstand des Rotors einen NETZ-RESET durchführen.</li> </ul>
TACHO ERROR	1, 2, 96.1	Ausfall der Drehzahlimpulse. Kein Rotor eingesetzt. Fehler / Defekt Elektronik	<ul style="list-style-type: none"> <li>- Nach Ablauf der angezeigten Wartezeit (150 Sekunden) einen NETZ-RESET durchführen.</li> <li>- Überprüfen, ob der Rotor eingesetzt ist.</li> </ul>
LID ERROR	4.1 – 4.127	Fehler Deckelverriegelung	<ul style="list-style-type: none"> <li>- Nach Stillstand des Rotors einen NETZ-RESET durchführen.</li> </ul>
OVER SPEED	5	Überdrehzahl	
ROTOR ERROR	10.1 – 10.6	Fehler Rotorcodierung	
VERSION ERROR	12	Falsches Zentrifugen-Modell erkannt. Fehler / Defekt Elektronik	
UNDER SPEED	13	Unterdrehzahl	

Anzeige		Ursache	Beseitigung
CTRL ERROR	22 – 25.4	Fehler / Defekt Elektronik	– Nach Stillstand des Rotors einen NETZ-RESET durchführen.
CRC ERROR	27, 27.1		
COM ERROR	31 – 36		
FC ERROR	60, 61.1 – 61.21, 61.64 – 61.142		
TACHO ERR	61.22	Fehler Drehzahlmessung	– Das Gerät darf nicht ausgeschaltet werden, solange die Meldung "Wait" angezeigt wird. Nachdem die Meldung "wait ...!" nicht mehr angezeigt wird, einen NETZ-RESET durchführen.
FC ERROR	61.23		
FC ERROR	61.153	Fehler / Defekt Elektronik	– Einen NETZ-RESET durchführen. – Die Beladung des Rotors überprüfen, siehe Kapitel "Beladen des Rotors". – Den Zentrifugationslauf wiederholen.
VERS. ERR	61.154	Ungültige Maschinenversion	– Einen NETZ-RESET durchführen.

## 26 Netzeingangssicherungen wechseln



Den Netzschalter ausschalten und das Gerät vom Netz trennen!

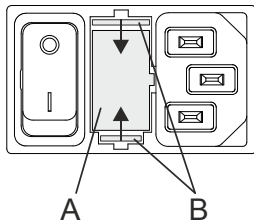

Der Sicherungshalter (A) mit den Netzeingangssicherungen befindet sich neben dem Netzschalter.

- Das Anschlusskabel aus dem Gerätestecker ziehen.
- Den Schnappverschluss (B) gegen den Sicherungshalter (A) drücken und diesen herausziehen.
- Defekte Netzeingangssicherungen austauschen.



Nur Sicherungen mit dem, für den Typ, festgelegten Nennwert verwenden, siehe nachfolgende Tabelle.

- Den Sicherungshalter wieder hineinschieben bis der Schnappverschluss einrastet.
- Das Gerät wieder ans Netz anschließen.

Modell	Typ	Sicherung	Best.-Nr.
EBA 280	1101	T 3,15 AH/250V	E997
EBA 280 S	1102	T 3,15 AH/250V	E997
EBA 280	1101-01	T 6,3 AH/250V	2266
EBA 280 S	1102-01	T 6,3 AH/250V	2266

## 27 Rücksendung von Geräten



Vor der Rücksendung des Gerätes muss die Transportsicherung eingebaut werden.

Wird das Gerät oder dessen Zubehör an die Firma Andreas Hettich GmbH & Co. KG zurückgesandt, so muss dieses, zum Schutz von Personen, Umwelt und Material, vor dem Versand dekontaminiert und gereinigt werden.

Eine Annahme von kontaminierten Geräten oder Zubehör behalten wir uns vor.

Anfallende Kosten für Reinigungs- und Desinfektionsmaßnahmen werden dem Kunden in Rechnung gestellt.

Wir bitten dafür um Ihr Verständnis.

## 28 Entsorgung

Vor der Entsorgung muss das Gerät, zum Schutz von Personen, Umwelt und Material, dekontaminiert und gereinigt werden.

Bei der Entsorgung des Geräts sind die jeweiligen gesetzlichen Vorschriften zu beachten.

Gemäß der Richtlinie 2002/96/EG (WEEE) dürfen alle nach dem 13.08.2005 gelieferten Geräte nicht mehr mit dem Hausmüll entsorgt werden. Das Gerät gehört zur Gruppe 8 (Medizinische Geräte) und ist in den Business-to-Business-Bereich eingeordnet.



Mit dem Symbol des durchgestrichenen Abfalleimers wird darauf hingewiesen, dass das Gerät nicht mit dem Hausmüll entsorgt werden darf.

Die Entsorgungsvorschriften der einzelnen EU-Länder können unterschiedlich sein. Im Bedarfsfall wenden Sie sich bitte an Ihren Lieferanten.

**Contents**

1	How to use these operating instructions .....	48
2	Symbol meanings .....	48
3	Intended use .....	48
4	Remaining risks .....	48
5	Technical specifications .....	49
6	Notes on safety .....	50
7	Transport and storage .....	51
7.1	Transport .....	51
7.2	Storage .....	51
8	Scope of delivery .....	51
9	Removing the transport securing device .....	52
10	Initial operation .....	52
11	Opening and closing the lid .....	53
11.1	Opening the lid .....	53
11.2	Closing the lid .....	53
12	Inserting and removing the rotor .....	54
13	Loading the rotor .....	55
14	Operating and display elements .....	56
14.1	Displayed symbols .....	56
14.2	Control panel keys .....	56
14.3	Setting options .....	57
15	Programming .....	58
15.1	Inputting or changing programs .....	58
15.2	Calling up programs .....	60
15.3	Saving programs .....	60
16	Centrifugation .....	61
16.1	Centrifugation with preset time .....	61
16.2	Continuous run .....	62
16.3	Short-term centrifugation .....	63
17	Emergency Stop .....	63
18	Rotor detection .....	64
19	Cycle counter .....	65
20	Settings and queries .....	66
20.1	Querying system information .....	67
20.2	Acoustic signal .....	68
20.3	Optical signal after ending the centrifugation run .....	69
20.4	Automatic unlocking of the lid after the centrifugation run .....	70
20.5	Backlighting of the display .....	71
20.6	Displayed centrifugation parameters after switching on the device .....	72
20.7	Activating/deactivating the "Dual time" function .....	73
20.8	Querying the hours of operation and the number of centrifugation runs .....	74
20.9	Resetting the cycle counter to zero .....	75
21	Relative centrifugal force (RCF) .....	76

22	Centrifugation of materials or mixtures of materials with a density higher than 1.2 kg/dm <sup>3</sup> .....	76
23	Emergency unlocking .....	76
24	Maintenance and servicing .....	77
24.1	Centrifuge (housing, lid and centrifuging chamber).....	77
24.1.1	Surface cleaning and care .....	77
24.1.2	Surface disinfection.....	77
24.1.3	Removal of radioactive contaminants .....	77
24.2	Rotors and Attachments.....	78
24.2.1	Cleaning and care.....	78
24.2.2	Disinfection .....	78
24.2.3	Removal of radioactive contaminants .....	78
24.2.4	Rotors and accessories with limited service lives .....	78
24.3	Autoclaving .....	79
24.4	Centrifuge containers .....	79
25	Faults .....	80
26	Change mains input fuses .....	82
27	Returning Devices .....	82
28	Disposal .....	82
29	Anhang / Appendix .....	160
29.1	Rotoren und Zubehör / Rotors and accessories.....	160

## 1 How to use these operating instructions

- Before using the centrifuge, read the operating instructions and observe them.
- The operating instructions are a part of the device. They must always be kept readily available.
- If the device is set up at a different location, the operating instructions must be provided with it.

## 2 Symbol meanings



Symbol on the device:

Attention, general hazard area.

Before using the device, make sure you read the operating instructions and observe the safety information!



Symbol in this document:

Attention, general hazard area.

This symbol refers to safety relevant warnings and indicates possibly dangerous situations.

The non-adherence to these warnings can lead to material damage and injury to personal.



Symbol on the device and in this document:

Beware of biohazard.



Symbol in this document:

This symbol refers to important circumstances.



Symbol on the device:

The symbol is on the housing, near the hinge.

Direction of rotation of the rotor.



Symbol on the device:

The symbol is located on the front of the housing, below the borehole.

The direction of rotation of the Allen key to unlock the lid in an emergency.



Symbol on the device and in this document:

Symbol for the separate collection of electric and electronic devices according to the guideline 2002/96/EG (WEEE). The device belongs to Group 8 (medical devices).

Applies in the countries of the European Union, as well as in Norway and Switzerland.

## 3 Intended use

This device is a medical product (laboratory centrifuge) within the context of the IVD Directive 98/79/EC.

The centrifuge was designed only for the separation of substances or mixtures with a density of no more than 1.2 kg/dm<sup>3</sup>, particularly of samples for preparation for human medical in-vitro diagnostics.

This especially includes the determination of potassium in blood serum. The running behaviour allows for gentle separation, thereby preventing the accumulation of additional erythrocytic potassium in the serum. This prevents the test results from being falsified.

The centrifuge is only meant for this purpose.

Another use or one which goes beyond this, is considered to be non-intended. The company Andreas Hettich GmbH & Co. KG is not liable for damage resulting from this.

Observing all information in the operating instructions and complying with the measures described therein is also a part of the intended use.

If the centrifuge is installed in another device or in a system, the manufacturer of the overall system is responsible for its safety.

## 4 Remaining risks

The device is built according to the state-of-the-art and the recognized safety regulations. If used and handled improperly, there could be life-threatening danger to the user or third parties, or the device could be impaired or there could be other property damage. The device is only to be used for its intended purpose and only when it is in safe working condition.

Malfunctions which could affect safety must be corrected immediately.



## 5 Technical specifications

Manufacturer	Andreas Hettich GmbH & Co. KG D-78532 Tuttlingen			
Model	EBA 280		EBA 280 S	
Type	1101	1101-01	1102	1102-01
Mains voltage ( $\pm 10\%$ )	200 - 240 V 1~	100 - 127 V 1~	200 - 240 V 1~	100 - 127 V 1~
Mains frequency	50 - 60 Hz	50 - 60 Hz	50 - 60 Hz	50 - 60 Hz
Connected load	185 VA	185 VA	330 VA	330 VA
Current consumption	0.85 A	1.75 A	1.6 A	3.0 A
Max. capacity	6 x 50 ml			
Allowed density	1.2 kg/dm <sup>3</sup>			
Speed (RPM)	6000			
Force (RCF)	4146		5031	
Kinetic energy	2700 Nm			
Obligatory inspection (BGR 500)	no			
Ambient conditions (EN / IEC 61010-1)	Indoors only Up to 2000 m above sea level 2°C to 40°C Maximum relative humidity 80% for temperatures up to 31°C, linearly decreasing to 50% relative humidity at 40°C.			
– Set-up site				
– Altitude				
– Ambient temperature				
– Humidity				
– Excess-voltage category (IEC 60364-4-443)	II			
– Pollution degree	2			
Device protection class	I			
Not suitable for use in explosion-endangered areas.				
EMC	EN / IEC 61326-1, Class B		FCC Class B	
– Emitted interference, Interference immunity	EN / IEC 61326-1, Klasse B		FCC Class B	
Noise level (dependent on rotor)	$\leq 51$ dB(A)		$\leq 56$ dB(A)	
Dimensions				
– Width	326 mm			
– Depth	389 mm			
– Height	242 mm			
Weight	approx. 11 kg			

## 6 Notes on safety



**No claim of warranty will be considered by the manufacturer unless ALL instructions in this manual have been followed.**



- **The centrifuge should be installed on a good, stable base.**
- **Before using the centrifuge, make sure you check that the rotor is engaged on the motor shaft.**
- **When the centrifuge is running, according to EN / IEC 61010-2-020, no persons, dangerous substances or objects may be within the safety margin of 300 mm around the centrifuge.**
- **Rotors, suspensions and accessories that possess traces of corrosion or mechanical damage or if their term of use has expired may not be used any longer.**
- **The centrifuge may no longer be put into operation when the centrifuging chamber has safety-related damages.**
- **For centrifuges without temperature control, when the room temperature is increased and/or if the device is frequently used, the centrifuging chamber could be heated up. Therefore, it can't be ruled out that the sample material might be changed due to the temperature.**

- **Before the initial operation of your centrifuge you should read and pay attention to the operating instructions. Only personnel that has read and understood the operating instructions are allowed to operate the device.**
- Along with the operating instructions and the legal regulations on accident prevention, you should also follow the recognised professional regulations for working in a safe and professional manner. These operating instructions should be read in conjunction with any other instructions concerning accident prevention and environmental protection based on the national regulations of the country where the device is to be used.
- This centrifuge is a state-of-the-art piece of equipment which is extremely safe to operate. However, it can lead to danger for users or others if used by untrained staff, in an inappropriate way or for a purpose other than that it was designed for.
- The centrifuge must not be moved or knocked during operation.
- In case of fault or emergency release, never touch the rotor before it has stopped turning.
- To avoid damage due to condensate, when changing from a cold to a warm room the centrifuge must either heat up for at least 3 hours in the warm room before being connected to the mains, or run hot for 30 minutes in the cold room.
- Only the rotors and accessories approved by the manufacturer for this device may be used (see chapter "Anhang/Appendix, Rotoren und Zubehör/Rotors and accessories"). Before centrifuge vessels are used which are not listed in the chapter "Appendix, Rotors and accessories", the user must make sure they can be used by asking the manufacturer.
- The centrifuge rotor may only be loaded in accordance with the chapter "Loading the rotor".
- When centrifuging with maxim revolutions per minute the density of the materials or the material mixtures may not exceed 1.2 kg/dm<sup>3</sup>.
- The centrifuge may only be operated when the balance is within the bounds of acceptability.
- The centrifuge may not be operated in explosion-endangered areas.
- The centrifuge must not be used with:
  - inflammable or explosive materials
  - materials that react with one another producing a lot of energy.
- If users have to centrifuge hazardous materials or compounds contaminated with toxic, radioactive or pathogenic micro-organisms, they must take appropriate measures.  
For hazardous substances centrifuge containers with special screw caps must strictly be used. In addition to the screw cap centrifuge containers, for materials in hazard category 3 and 4 a biosafety system must be used (see the World Health Organisation's "Laboratory Biosafety Manual").  
No biosafety systems are available for this centrifuge.
- The centrifuge must not be operated with highly corrosive substances which could impair the mechanical integrity of rotors, hangers and accessories.

- Repairs must only be carried out by personnel authorised to do so by the manufacturer.
- Only original spare parts and original accessories licensed by the Andreas Hettich GmbH & Co. KG company are allowed to be utilised.
- The following safety regulations apply:  
EN / IEC 61010-1 EN / IEC 61010-2-020 as well as their national deviations.
- The safe operation and reliability of the centrifuge can only be guaranteed if:
  - the centrifuge is operated in accordance with the operating instructions,
  - the electrical installation on the site where the centrifuge is installed conforms to the demands of EN / IEC stipulations,
  - the tests for device safety required in the respective countries, e.g. in Germany in acc. with BGV A1 and BGR 500, are carried out by an expert.

## 7 Transport and storage

### 7.1 Transport



Before transporting the device, the transport securing device must be installed.

When the device and accessories are transported, the following ambient conditions must be complied with:

- Ambient temperature: -20°C to +60°C
- Relative humidity: 20% to 80%, non-condensing

### 7.2 Storage



The device and the accessories may only be stored in closed and dry rooms.

When the device and accessories are stored, the following ambient conditions must be complied with:

- Ambient temperature: -20°C to +60°C
- Relative humidity: 20% to 80%, non-condensing

## 8 Scope of delivery

The following accessories are delivered with the centrifuge:

- 1 connecting cable
- 2 fuses
- 1 hex head wrench
- 1 copy of operating instructions
- 1 information sheet, transport securing device
- 1 information sheet, emergency unlocking

The rotor(s) and associated accessories are included in the delivery in the quantity ordered.

## 9 Removing the transport securing device



It is imperative that the transport securing device be removed.

Keep the transport securing device in a safe place since it must be installed again before transporting the device.

The device may only be transported with the transport securing device installed.

To protect the device from damage during transport, the motor is fixed in place.  
This transport securing device must be removed when the device is put into operation.

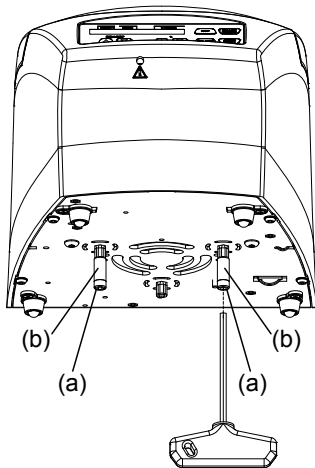

- Remove the two screws (a) and spacer sleeves (b).



The transport securing device is installed in the opposite order.

## 10 Initial operation

- Remove the transport securing device from the housing floor; see the "Removing the transport securing device" chapter.
- **Position the centrifuge in a stable and level manner in a suitable place. During set-up, the required safety margin of 300 mm around the centrifuge is to be kept according to EN / IEC 61010-2-020.**



**When the centrifuge is running, according to EN / IEC 61010-2-020, no persons, dangerous substances or objects may be within the safety margin of 300 mm around the centrifuge.**

- Do not place any object in front of the ventiduct.  
Keep a ventilation area of 300 mm around the ventiduct.
- Check whether the mains voltage tallies with the statement on the type plate.
- Connect the centrifuge with the connection cable to a standard mains socket. For connection ratings refer to Chapter "Technical specifications".
- Switch on the mains switch (switch position "I"). The LEDs will briefly light up.  
The following displays appear one after the other:
  1. The centrifuge model
  2. The type number and program version
  3. The rotor code (R) and the maximum speed of the rotor (maxRPM) of the last rotor detected by the rotor detector
  4. The centrifugation parameters of the last used program or program 1



If the lid is closed, the message "Open the lid" is displayed.  
In this case, open the lid to display the centrifugation parameters.

## 11 Opening and closing the lid

### 11.1 Opening the lid



The lid can only be opened if the centrifuge is switched on and the rotor is stationary. If this shouldn't be possible, see the "Emergency unlock" chapter.



When the cycle counter is activated, after a centrifugation run, while opening the lid, the remaining number of running cycles (centrifugation runs) is briefly displayed.

Example:

PROG	RCF<	RPM	t/min:s
RemCycles= 16703			



- Press the key.  
The lid is unlocked by the motor.  
 : Lid unlocked.  
The left LED in the key will go out.

Example:

PROG	RCF<	RPM	t/min:s
1	6	4500	5:00

### 11.2 Closing the lid



Do not reach with your fingers between the lid and housing.  
Do not slam the lid closed.

- Put the lid on and lightly press the front edge of the lid down.  
The lid is locked by the motor.  
 : Lid locked.

The left LED in the  key is illuminated.

Example:

PROG	RCF<	RPM	t/min:s
1	6	4500	5:00

## 12 Inserting and removing the rotor

### Rotor with unlocking knob

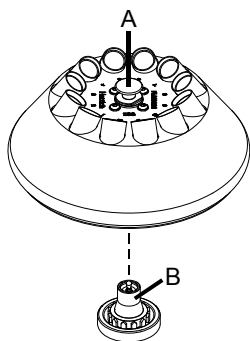

#### Inserting the rotor:



Dirt particles between the motor shaft and rotor prevent the rotor from having a perfect seat and cause it to run unsteadily. If necessary, clean the motor shaft (B) and the rotor hub before inserting the rotor.

- Lift up the rotor by the unlocking knob (A) and place horizontally on the motor shaft (B). The rotor will automatically engage on the motor shaft.
- Hold the rotor firmly at the left and right and pull up lightly to check whether it has properly engaged on the motor shaft.

#### Removing the rotor:

- Pull up the unlocking knob (A) on the rotor, hold onto it and lift the rotor from the motor shaft.

### Rotor without unlocking knob

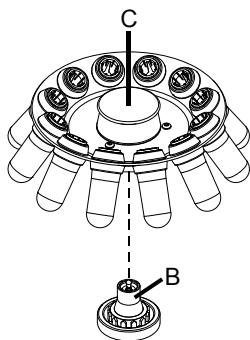

#### Inserting the rotor:



Dirt particles between the motor shaft and rotor prevent the rotor from having a perfect seat and cause it to run unsteadily. If necessary, clean the motor shaft (B) and the rotor hub before inserting the rotor.

- Lift up the rotor by the handle (C), place it horizontally on the motor shaft (B) and press down as far as it can go.

#### Removing the rotor:

- Hold the rotor firmly by the handle (C) and lift it off of the motor shaft.

### 13 Loading the rotor



Standard centrifuge containers of glass will not stand RCF values exceeding 4000 (DIN 58970, pg. 2).

- Hold the rotor firmly at the left and right and pull up lightly to check whether it has properly engaged on the motor shaft.
- With swing-out rotors all rotor positions must be lined with **identical** hangers.
- The rotors and hangers may only be loaded symmetrically. The centrifuge containers have to be distributed evenly on all rotor positions. For authorised combinations see Chapter "Anhang/Appendix, Rotoren und Zubehör/Rotors and accessories".  
In the case of angle rotors all possible rotor positions must be loaded, see chapter "Anhang/Appendix, Rotoren und Zubehör/Rotors and accessories".

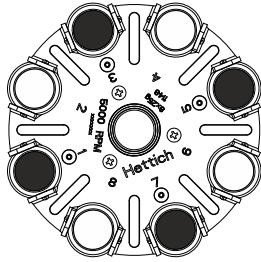

Rotor is evenly loaded

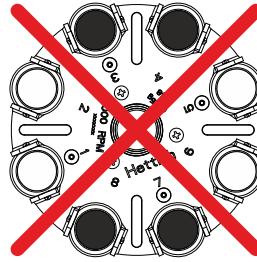

**Not permitted!**  
Rotor is not evenly loaded

- In containers with rubber inserts, the same number of rubber inserts must always be among the centrifuge containers.
- The centrifuge containers may only be filled outside of the centrifuge.
- The maximum filling quantity for the centrifuge containers specified by the manufacturer must not be exceeded.

In the case of angle rotors, the centrifuging vessels may only be filled so far that no fluid can be expelled from them while the centrifuge is running.

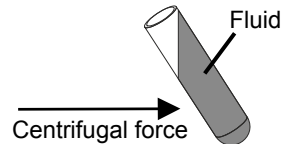

- When loading the angle rotors, no liquid may get into the angle rotors or centrifuging chamber.
- When loading the hangers and swing-out rotors and when swivelling out the hangers while the centrifuge is running, no liquid may enter the hangers or the centrifuging chamber.
- In order to maintain the weight differences within the centrifuge container as marginal as possible, a consistent fill level in the containers is to be heeded.
- The weight of the permissible filling quantity is specified on each rotor. This weight may not be exceeded.

## 14 Operating and display elements



### 14.1 Displayed symbols



Lid unlocked.



Lid locked.



Rotation display. The rotation display lights up, rotating counter clockwise, as long as the rotor is turning.

### 14.2 Control panel keys



- Calling up programs
- Save program.



- Switching between the RPM display (RPM) and RCF display (>RCF<). RCF values are displayed in parentheses >◀.
  - The LED above the key will light up if the RCF display is activated.
- RPM Speed  
RCF : Relative centrifugal acceleration



- Selection key for activating the individual parameters. Every time the key is pressed, the next parameter is activated.
- Call up the "MACHINE MENU" (keep the key pressed for 8 seconds).
- In the "Machine Menu", select the menus "-> Info", "-> Settings" and "-> Time & Cycles".
- Scroll forward in the menus.



- Change the value of a previously selected parameter.
- If the key is kept pressed, the value changes with increasing speed.



- Start the centrifugation run. The LED in the key will be illuminated during the centrifugation run as long as the rotor is turning.
- Short-term centrifugation. Centrifugation is run as long as the key is kept pressed. The LED in the key will be illuminated during the centrifugation run as long as the rotor is turning.
- Save inputs and changes.
- Call up the menus "-> Info", "-> Settings" and "-> Time & Cycles".



- Finish the centrifugation run. The rotor runs down with a pre-selected brake stage. The right LED in the button is illuminated until the rotor is still. After the rotor stops, the left LED in the key will light up. Pressing the key twice triggers the Emergency Stop.
- Unlock the lid. The left LED in the key will go out.



### 14.3 Setting options

**PROG RCL Program location of the program to be called**  
The program locations 1 to 9 and # can be called.

**t/min Runtime.** Adjustable from 1 - 99 min, in steps of 1 minute.

**t/sec Runtime.** Adjustable from 1 - 59 s, in steps of 1 second.

**Continuous run "--:--".** Set the parameters **t/min** and **t/sec** to zero.

**Begins at START Counting the runtime.**  
The runtime begins counting immediately after the centrifugation run begins.

**Begins at SPEED** The runtime only begins counting after reaching the set speed.

 This setting is only possible when the "Dual time" function is activated. See the "Activating/deactivating the 'Dual time' function" chapter. This function is activated ex works.

**RPM Speed**  
A number value from 200 rpm to the maximum speed of the rotor can be set.  
Settable in increments of 10.  
For the maximum rotor speed, see the chapter "Appendix, Rotors and accessories".

**RAD/mm Centrifuging radius**  
Adjustable from 10 mm to 330 mm, in steps of 1 mm.  
For the centrifuging radius, see the chapter "Appendix, Rotors and accessories".

 It is only possible to input the centrifuging radius if the RCF display (➤RCF◀) is activated.

**RCF Relative centrifugal acceleration**  
A number value can be set which results in a speed between 200 rpm and the maximum rotor speed.  
Settable in increments of 1.

 It is only possible to input the relative centrifugal acceleration (RCF) if the RCF display (➤RCF◀) is activated.  
The relative centrifugal acceleration (RCF) depends on the centrifuging radius (RAD). The relative centrifugal acceleration RCF and the set centrifuging radius (RAD) are displayed.



**Starting steps 1 - 9.** Step 9 = shortest starting time, Step 1 = longest starting time.



**Brake steps 0 - 9.** Step 9 = shortest run-down time, Step 1 = long run-down time, Step 0 = longest run-down time (brakeless run-down).

**PROG STO Program location where the program is stored.**  
9 different programs can be stored (program locations 1 to 9).

 No programs should be saved at program location #.  
The program location # serves as intermediate memory for changed centrifugation parameters.  
The centrifugation parameters at program location # are overwritten every time a centrifugation run is carried out with changed centrifugation parameters which were not saved to a program location.

## 15 Programming



No programs should be saved at program location #.

The program location # serves as intermediate memory for changed centrifugation parameters.

If centrifugation parameters are changed, but are not saved to a program location afterwards, the display shows a dash "-" instead of the program location number. After starting the centrifugation run, these centrifugation parameters are then automatically saved at program location #.

The centrifugation parameters at program location # are overwritten every time a centrifugation run is carried out with changed centrifugation parameters which were not saved to a program location.

### 15.1 Inputting or changing programs



In order to set the continuous run, the parameters **t/min** and **t/sec** must be set to zero. In the time display (t/min:s), "--:--" appears.

Example:



The relative centrifugal force (RCF) depends on the centrifuging radius (RAD). A correct calculation is only possible if the right centrifuging radius is set. During the input of the RCF, the set centrifuging radius is displayed.

Example:



It is only possible to display and input the relative centrifugal force (RCF) and the centrifuging radius (RAD) if the RCF display (>RCF<) is activated.

If no key is pressed for 8 seconds after selection or during parameter input, the previous values are shown on the display. The parameters must then be input again.

Entering parameters can be cancelled at any time by pressing the  key. In this case, the settings are not stored.



- Press the key.  
**PROG RCL** : Program location of the displayed centrifugation parameters.



- With the keys, set the program location whose centrifugation parameters are to be displayed.



- Press the key.  
The centrifugation parameters are displayed.

















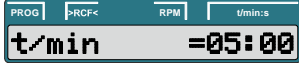

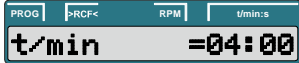
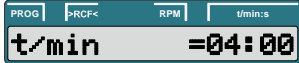

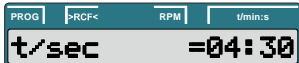
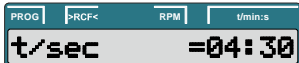

Continued on next page

#### Example: RPM display (RPM)





#### Example: RCF display (>RCF<)



	<ul style="list-style-type: none"> <li>Press the key to activate the RPM display (RPM) or the RCF display (&gt;RCF&lt;) as needed. The LED above the key is illuminated if the RCF display (&gt;RCF&lt;) is activated.</li> </ul>	<p><b>Example:</b> RPM display (RPM)</p> 	<p><b>Example:</b> RCF display (&gt;RCF&lt;)</p> 
↓			
	<ul style="list-style-type: none"> <li>Keep pressing the key until the desired centrifugation parameter is displayed. Example: <b>t/min</b> : Runtime, minutes.</li> </ul>		
↓			
	<ul style="list-style-type: none"> <li>Set the desired value with the keys.</li> </ul>		
↓			
	<ul style="list-style-type: none"> <li>Input all the desired centrifugation parameters in succession.</li> </ul>		
↓			
	<ul style="list-style-type: none"> <li>Press the key until the following is displayed: <b>PROG STO</b> : Program location where the centrifugation parameters are stored.</li> </ul>		
↓			
	<ul style="list-style-type: none"> <li>Set the desired program location with the keys.</li> </ul>		
↓			
	<ul style="list-style-type: none"> <li>Press the key. The centrifugation parameters are stored at the program location.</li> </ul>		
			

### 15.2 Calling up programs

- 
 • Press the key.  
**PROG RCL** : Program location of the displayed centrifugation parameters.
- ↓
   

 • With the keys, set the program location whose centrifugation parameters are to be displayed.
- ↓
   

 • Press the key.  
 The centrifugation parameters are displayed.



Example:  
RPM display (RPM)



Example:  
RCF display (>RCF<)



### 15.3 Saving programs

- 
 • Press the key twice.  
**PROG STO** : Program location where the centrifugation parameters are stored.
- ↓
   

 • With the keys, set the program location where the centrifugation parameters are to be stored.
- ↓
   

 • Press the key.  
 The centrifugation parameters are stored at the program location.

Example:  
RPM display (RPM)



Example:  
RCF display (>RCF<)



## 16 Centrifugation

 In accordance with EN / IEC 61010-2-020, no persons, hazardous substances or objects may be within a safety range 300 mm around the centrifuge during a centrifugation run.

 After each centrifugation run, while the lid is unlocking, the remaining number of running cycles (centrifugation runs) will be briefly displayed.

Example:



If the permissible weight difference within the rotor load is exceeded, the centrifugation run is aborted during the start-up and the following display appears:



A centrifugation run can be aborted at any time by pressing the  key.

During a centrifugation run, centrifugation parameters can be selected and changed. The changed values are stored at program location #.

With the  key, you can toggle between the RPM display (RPM) and RCF display (>RCF<) at any time. If the RCF display (>RCF<) is worked with, the centrifuging radius must be input.

The following is displayed:



Further operation of the centrifuge is then only possible after opening the lid.

Operation errors and malfunctions will be shown (see the chapter on "Malfunctions").

- Plug in the mains switch. Switch position I.
- Load the rotor and close the centrifuge lid.

### 16.1 Centrifugation with preset time



- Press the key to activate the RPM display (RPM) or the RCF display (>RCF<) as needed. The LED above the key is illuminated if the RCF display (>RCF<) is activated.



- Input the desired centrifugation parameters (see the "Programming" chapter).



- Press the key. The centrifugation run is started. During the centrifugation run, the rotor speed or the resulting RCF value and remaining time are displayed.





Continued on next page

Example:  
RPM display (RPM)



Example:  
RCF display (>RCF<)



- After the time elapses or if the centrifugation run is aborted by pressing the  key, the run-out occurs with the set brake stage. The brake stage is displayed. Example 

Example:  
RPM display (RPM)



Example:  
RCF display (>RCF<)



## 16.2 Continuous run



- Press the key to activate the RPM display (RPM) or the RCF display (>RCF<) as needed. The LED above the key is illuminated if the RCF display (>RCF<) is activated.



- Input the desired centrifugation parameters. Set the parameters **t/min** and **t/sec** to zero (see the "Programming" chapter).



- Press the key. The centrifugation run is started. During the centrifugation run, the rotor speed or the resulting RCF value and elapsed time are displayed.



- Press the key. The centrifugation run is ended. The run-out occurs with the set brake stage. The brake stage is displayed. Example 

Example:  
RPM display (RPM)



Example:  
RCF display (>RCF<)



### 16.3 Short-term centrifugation



- Press the key to activate the RPM display (RPM) or the RCF display (>RCF<) as needed. The LED above the key is illuminated if the RCF display (>RCF<) is activated.



- Input the desired centrifugation parameters (see the "Programming" chapter).



- Press the key and keep it pressed. During the centrifugation run, the rotor speed or the resulting RCF value and elapsed time are displayed.



- Release the key again. The centrifugation run is ended. The run-out occurs with the set brake stage. The brake stage is displayed. Example  $\sim\sim 7$ .

Example:  
RPM display (RPM)



Example:  
RCF display (>RCF<)

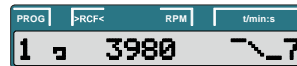

### 17 Emergency Stop



- Press the key twice. During the Emergency Stop, the run-out occurs at brake stage 9 (shortest run-out time). Brake stage  $\sim\sim 9$  is displayed.

Example:  
RPM display (RPM)



Example:  
RCF display (>RCF<)



## 18 Rotor detection

The centrifuge is equipped with automatic rotor detection.

Rotor detection is carried out after starting each centrifugation run.

If the rotor code of a rotor is read in for the first time by the rotor detection, the centrifugation run then stops automatically after rotor detection. The rotor code (R) and the maximum speed (maxRPM) of the rotor permitted for this centrifuge are displayed.

Example:



After the rotor comes to a standstill (the left LED in the  key is illuminated), press any key. Afterwards, the maximum permissible number of run cycles is displayed.

Example:



Now, the maximum permissible number of run cycles of the rotor/hangers must be set (see the "Cycle counter" chapter).

When using a rotor whose rotor code has already been read in by the rotor detection, after starting the centrifugation run, the maximum speed (ROTOR MAX) of the rotor permissible for this centrifuge is briefly displayed.

Example:



 If the set speed is greater than the maximum speed of the rotor permissible for this centrifuge, the centrifugation run is aborted after rotor detection and the following displays alternately appear:

Example:



In this case, the speed on the display must be checked and adapted to the maximum rotor speed.



## 19 Cycle counter



The period of use of certain rotors and hangers is limited to a maximum number of run cycles (centrifugation runs). The rotors and hangers in question are labeled with the maximum permissible number of run cycles.

The centrifuge is equipped with a cycle counter, which counts the running cycles (centrifugation runs) of the various rotor codes (see also the "Rotor detection" chapter).

After each centrifugation run, while the lid is unlocking, the remaining number of running cycles (centrifugation runs) will be briefly displayed.

Example:



If the maximum permissible number of running cycles has been exceeded, the following is displayed every time the centrifugation run is started, and the centrifugation run must be restarted.



If this display appears:



the rotor or hanger in question must be immediately exchanged for a new rotor/hanger for safety reasons.

After the rotor/hanger has been exchanged, the cycle counter of the respective rotor code must be reset to zero again (see "Resetting the cycle counter to zero" chapter).

If the rotor code of a rotor is read in for the first time by the rotor detection, the centrifugation run then stops automatically after rotor detection. The rotor code (R) and the maximum speed (maxRPM) of the rotor permitted for this centrifuge are displayed.

Afterwards, the maximum permissible number of run cycles of the rotor/hanger must be set.



In the case of swing-out rotors, the maximum permissible number of run cycles of the hangers must always be set.

The maximum permissible number of run cycles of the rotor/hanger must be set as follows.

### Example:

Display after rotor detection.

**R** : Rotor code of the rotor.

**maxRPM** : The maximum speed of the rotor permitted for this centrifuge.



Press any key.

- Wait until the left LED in the  key is illuminated.
- Press any key. The maximum permissible number of run cycles will be displayed.



Continued on next page

**Example:**

- Check whether the displayed maximum number of run cycles matches the specifications on the rotor/hangers.



If not, the maximum permissible number of run cycles specified on the rotor/hangers must be set.

- For rotors and hangers whose period of use is not limited to a maximum number of run cycles (centrifugation runs), zero must be set.



- Set the correct value with the keys.



- Press the key. The maximum permissible number of run cycles is saved.



**20 Settings and queries**

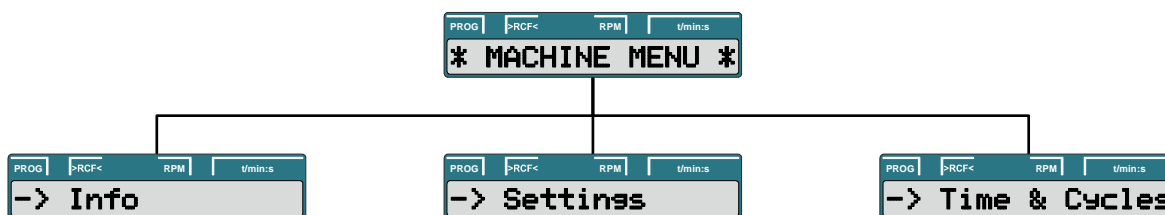

**Query:**

- System information (section 20.1)

**Setting:**

- Acoustical signal (section 20.2)
- Automatic unlocking of the lid after the centrifugation run (section 20.4)
- Automatic switch-off of the background lighting (section 20.5)
- Optical signal after ending the centrifugation run (section 20.3)
- Displayed centrifugation parameters after switching on the device (section 20.6)
- Activating/deactivating the "Dual time" function (section 20.7)

**Query:**

- Hours of operation (section 20.8)
- Number of carried-out centrifugation runs (section 20.8)

**Setting:**



- Cycle counter (section 20.9)

















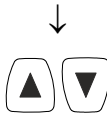

### 20.1 Querying system information

The following system information can be queried:

- Centrifuge model
- The maximum speeds of the various rotor codes,
- Centrifuge program version
- Frequency converter type
- Frequency converter program version

With the rotor at a standstill, the query can proceed as follows:

 The procedure can be aborted at any time by pressing the  key.

	<ul style="list-style-type: none"> <li>• Press and hold the button for eight seconds.</li> </ul>		
	<ul style="list-style-type: none"> <li>• Press the key.</li> </ul>		
	<ul style="list-style-type: none"> <li>• Press the key.</li> </ul>		
	<ul style="list-style-type: none"> <li>• Press the key.</li> <li>• <b>R</b> : Rotor code of the rotor.</li> <li>• <b>*</b> : The rotor code of the currently used rotor is marked with an asterisk.</li> <li>• <b>RPMmax</b> : The maximum speed of the rotor permitted for this centrifuge.</li> </ul>	<p>Example:</p> 	
	<ul style="list-style-type: none"> <li>• The maximum speeds of the various rotor codes can be displayed with the keys.</li> </ul>	<p>Example:</p> 	
	<ul style="list-style-type: none"> <li>• Press the key.</li> </ul>	<p>Example:</p> 	
	<ul style="list-style-type: none"> <li>• Press the key.</li> </ul>	<p>Example:</p> 	
	<ul style="list-style-type: none"> <li>• Press the key.</li> </ul>	<p>Example:</p> 	
	<ul style="list-style-type: none"> <li>• Press the key twice to exit the "-&gt; Info" menu or press three times to exit the "* MACHINE MENU *".</li> </ul>		<p>Example:</p> 



## 20.2 Acoustic signal























The acoustic signal sounds:

- after a malfunction occurs in a 2-second interval.
- after ending the centrifugation run and the rotor is at a standstill in a 30-second interval.

The acoustic signal is ended by pressing any key.

If the rotor is at a standstill, the acoustic signal can be set as follows:

 The procedure can be aborted at any time by pressing the  key. In this case, the settings are not stored.

	<ul style="list-style-type: none"> <li>• Press and hold the button for eight seconds.</li> </ul>	
↓		
	<ul style="list-style-type: none"> <li>• Press the key until the following is displayed:</li> </ul>	
↓		
	<ul style="list-style-type: none"> <li>• Press the key.  <b>End beep</b> : Acoustic signal after ending the centrifugation run.  <b>off</b> : Signal deactivated.  <b>on</b> : Signal activated.</li> </ul>	 
↓		
	<ul style="list-style-type: none"> <li>• Set with the <b>off</b> or <b>on</b> keys.</li> </ul>	 
↓		
	<ul style="list-style-type: none"> <li>• Press the key.  <b>Error beep</b> : Acoustic signal after a malfunction occurs.  <b>off</b> : Signal deactivated.  <b>on</b> : Signal activated.</li> </ul>	 
↓		
	<ul style="list-style-type: none"> <li>• Set with the <b>off</b> or <b>on</b> keys.</li> </ul>	 
↓		
	<ul style="list-style-type: none"> <li>• Press the key.  <b>Beep volume</b> : Volume of the acoustic signal.  <b>min</b> : soft  <b>mid</b> : medium  <b>max</b> : loud</li> </ul>	 
↓		
	<ul style="list-style-type: none"> <li>• Set with the <b>min</b>, <b>mid</b>, or <b>max</b> key.</li> </ul>	  

↓

Continued on next page



- Press the key to save the setting.



- Press the key once to exit the "-> Settings" menu or press twice to exit the "\* MACHINE MENU \*".



Example:



### 20.3 Optical signal after ending the centrifugation run

The backlighting of the display flashes after the centrifugation run to visually signalize that the centrifugation run has finished.

The optical signal can be switched on or off when the rotor is at a standstill:

The procedure can be aborted at any time by pressing the key.



- Press and hold the button for eight seconds.



- Press the key until the following is displayed:



- Press the key.



- Press the key until one of the following is displayed:  
**End blinking** : Backlighting of display flashes after the centrifugation run.  
**off** : Backlighting does not flash.  
**on** : Backlighting flashes.



- Set with the **off** or **on** keys.



- Press the key to save the setting.



- Press the key once to exit the "-> Settings" menu or press twice to exit the "\* MACHINE MENU \*".





Example:





















### 20.4 Automatic unlocking of the lid after the centrifugation run

It can be set whether the lid should automatically unlock or not after the centrifugation run.

With the rotor at a standstill, this can be set as follows:



 The procedure can be aborted at any time by pressing the  key. In this case, the settings are not stored.



















	<ul style="list-style-type: none"> <li>Press and hold the button for eight seconds.</li> </ul>		
↓			
	<ul style="list-style-type: none"> <li>Press the key until the following is displayed:</li> </ul>		
↓			
	<ul style="list-style-type: none"> <li>Press the key.</li> </ul>		
↓			
	<ul style="list-style-type: none"> <li>Press the key until one of the following is displayed:  <b>Lid AutoOpen</b> : Automatic unlocking of the lid after the centrifugation run.  <b>off</b> : Lid does not unlock automatically.  <b>on</b> : Lid unlocks automatically.</li> </ul>		
↓			
	<ul style="list-style-type: none"> <li>Set with the <b>off</b> or <b>on</b> keys.</li> </ul>		
↓			
	<ul style="list-style-type: none"> <li>Press the key to save the setting.</li> </ul>		
			
↓			
	<ul style="list-style-type: none"> <li>Press the key once to exit the "-&gt; Settings" menu or press twice to exit the "* MACHINE MENU *".</li> </ul>		<p>Example:</p> 

### 20.5 Backlighting of the display

To save energy, it can be set that, after a centrifugation run, the backlighting of the display switches off after 2 minutes.

With the rotor at a standstill, this can be set as follows:

 The procedure can be aborted at any time by pressing the  key. In this case, the settings are not stored.

	<ul style="list-style-type: none"> <li>Press and hold the button for eight seconds.</li> </ul>		
↓		<ul style="list-style-type: none"> <li>Press the key until the following is displayed:</li> </ul>	
↓		<ul style="list-style-type: none"> <li>Press the key.</li> </ul>	 
↓		<ul style="list-style-type: none"> <li>Press the key until one of the following is displayed:  <b>Power save</b> : Automatic shutdown of the backlighting.  <b>off</b> : Automatic shutdown deactivated.  <b>on</b> : Automatic shutdown activated.</li> </ul>	 
↓		<ul style="list-style-type: none"> <li>Set with the <b>off</b> or <b>on</b> keys.</li> </ul>	 
↓		<ul style="list-style-type: none"> <li>Press the key to save the setting.</li> </ul>	 
↓		<ul style="list-style-type: none"> <li>Press the key once to exit the "-&gt; Settings" menu or press twice to exit the "* MACHINE MENU *".</li> </ul>	



Example:



















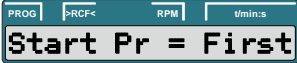
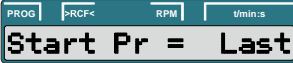

## 20.6 Displayed centrifugation parameters after switching on the device

It can be set whether the centrifugation parameters of the last used program or of program 1 should be displayed after switching on the device.

With the rotor at a standstill, this can be set as follows:

 The procedure can be aborted at any time by pressing the  key. In this case, the settings are not stored.



	<ul style="list-style-type: none"> <li>Press and hold the button for eight seconds.</li> </ul>		
↓			
	<ul style="list-style-type: none"> <li>Press the key until the following is displayed:</li> </ul>		
↓			
	<ul style="list-style-type: none"> <li>Press the key.</li> </ul>		
↓			
	<ul style="list-style-type: none"> <li>Press the key until one of the following is displayed:  <b>Start Pr</b> : Displayed program after switching on.  <b>First</b> : Program 1.  <b>Last</b> : Last used program.</li> </ul>		
↓			
	<ul style="list-style-type: none"> <li>Set <b>First</b> or <b>Last</b> with the keys.</li> </ul>		
↓			
	<ul style="list-style-type: none"> <li>Press the key to save the setting.</li> </ul>		
			
↓			
	<ul style="list-style-type: none"> <li>Press the key once to exit the "-&gt; Settings" menu or press twice to exit the "* MACHINE MENU *".</li> </ul>		<p>Example:</p> 





















### 20.7 Activating/deactivating the "Dual time" function

In order to be able to set the runtime counter (parameter **Begins at START** and parameter **Begins at SPEED**), the "Dual time" function must be activated. This function is activated ex works.

With the rotor at a standstill, this can be set as follows:

 The procedure can be aborted at any time by pressing the  key. In this case, the settings are not stored.

	<ul style="list-style-type: none"> <li>• Press and hold the button for eight seconds.</li> </ul>		
↓			
	<ul style="list-style-type: none"> <li>• Press the key until the following is displayed:</li> </ul>		
↓			
	<ul style="list-style-type: none"> <li>• Press the key.</li> </ul>		
↓			
	<ul style="list-style-type: none"> <li>• Press the key until one of the following is displayed:  <b>Dual time</b> : Counting the runtime.  <b>on</b> : Function activated.  <b>off</b> : Function deactivated.</li> </ul>		
↓			
	<ul style="list-style-type: none"> <li>• Set with the <b>off</b> or <b>on</b> keys.</li> </ul>		
↓			
	<ul style="list-style-type: none"> <li>• Press the key to save the setting.</li> </ul>		
↓			
	<ul style="list-style-type: none"> <li>• Press the key once to exit the "-&gt; Settings" menu or press twice to exit the "* MACHINE MENU *".</li> </ul>		<p>Example:</p> 



## 20.8 Querying the hours of operation and the number of centrifugation runs

The hours of operation are divided into internal and external hours of operation.

Internal hours of operation: Total time the device was switched on.

External hours of operation: Total time of the previous centrifugation runs.

With the rotor at a standstill, the query can proceed as follows:

 The procedure can be aborted at any time by pressing the  key.



- Press and hold the button for eight seconds.



- Press the key until the following is displayed:



- Press the key.  
**TimeExt** : External hours of operation.

Example:



- Press the key.  
**TimeInt** : Internal hours of operation.

Example:



- Press the key.  
**Starts** : Number of all centrifugation runs.

Example:



- Press the key twice to exit the "-> Time & Cycles" menu or press three times to exit the "\* MACHINE MENU \*".



Example:





















### 20.9 Resetting the cycle counter to zero

After the rotor/hanger has been exchanged, the cycle counter of the respective rotor code must be reset to zero again.

 The cycle counter may only be reset to zero if the rotor/hanger has been exchanged for a new rotor/hanger first.

With the rotor at a standstill, the cycle counter can be reset as follows:

 The procedure can be aborted at any time by pressing the  key. In this case, the settings are not stored.

	<ul style="list-style-type: none"> <li>Press and hold the button for eight seconds.</li> </ul>	
↓		
	<ul style="list-style-type: none"> <li>Press the key until the following is displayed:</li> </ul>	
↓		
	<ul style="list-style-type: none"> <li>Press the key.</li> </ul>	<p>Example:</p> 
↓		
	<ul style="list-style-type: none"> <li>Press the key until the following is displayed: <b>Cyc sum</b> : Number of completed run cycles.</li> </ul>	
↓		
	<ul style="list-style-type: none"> <li>Press the key.</li> </ul>	
↓		
	<ul style="list-style-type: none"> <li>Press the key. The number of completed run cycles is reset to zero.</li> </ul>	
↓		
	<ul style="list-style-type: none"> <li>Press the key to save the setting.</li> </ul>	 
↓		
	<ul style="list-style-type: none"> <li>Press the key twice to exit the "-&gt; Time &amp; Cycles" menu or press three times to exit the "* MACHINE MENU *".</li> </ul>	

Example:



## 21 Relative centrifugal force (RCF)

The relative centrifugal force (RCF) is given as a multiple of the acceleration of gravity (g). It is a unit-free value and serves to compare the separation and sedimentation performance.

These values are calculated using the formula below:

$$\text{RCF} = \left( \frac{\text{RPM}}{1000} \right)^2 \times r \times 1,118 \quad \Rightarrow \quad \text{RPM} = \sqrt{\frac{\text{RCF}}{r \times 1,118}} \times 1000$$

RCF = relative centrifugal force

RPM = rotational speed (revolutions per minute)

r = centrifugal radius in mm = distance from the centre of the turning axis to the bottom of the centrifuge.

For more on the centrifugal radius see the chapter "Anhang/Appendix, Rotoren und Zubehör/Rotors and accessories".



The relative centrifugal force (RCF) stands in relation to the revolutions per minute and the centrifugal radius.

## 22 Centrifugation of materials or mixtures of materials with a density higher than 1.2 kg/dm<sup>3</sup>

When centrifuging with maximum revolutions per minute the density of the materials or the material mixtures may not exceed 1.2 kg/dm<sup>3</sup>.

The speed must be reduced for materials or mixtures of materials with a higher density.

The permissible speed can be calculated using the following formula:

$$\text{Reduced speed (n}_{\text{red}}) = \sqrt{\frac{1.2}{\text{Greater density [kg/dm}^3]}} \times \text{maximum speed [RPM]}$$

e.g.: maximum speed RPM 4000, density 1.6 kg/dm<sup>3</sup>

$$n_{\text{red}} = \sqrt{\frac{1.2 \text{ kg/dm}^3}{1.6 \text{ kg/dm}^3}} \times 4000 \text{ RPM} = 3464 \text{ RPM}$$

If in doubt you should obtain clarification from the manufacturer.

## 23 Emergency unlocking

In the event of a power failure, the lid cannot be unlocked with the motor. Emergency unlocking must be done by hand.



To unlock in an emergency, disconnect the centrifuge from the mains.  
Open the lid only when the rotor is at a standstill.



CAUTION! Damage to the lock during emergency unlocking by turning the hexagon Allen key in clockwise direction (to the right).

The Allen key may only be turned counter clockwise (to the left); see figure.

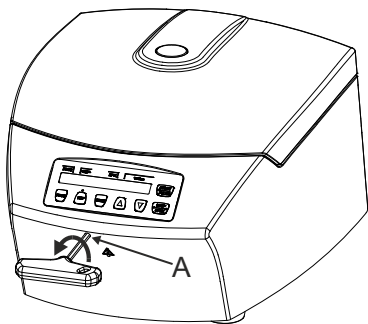

- Switch of the mains switch (switch setting "0").
- Look through the window in the lid to make sure that the rotor is at a standstill.
- Insert the Allen key horizontally in the bore (A) and turn carefully counter clockwise (to the left) until the lid opens.
- Pull the Allen key back out of the bore.

## 24 Maintenance and servicing



The device can be contaminated.



Pull the mains plug before cleaning.

Before any other cleaning or decontamination process other than that recommended by the manufacturer is applied, the user has to check with the manufacturer that the planned process does not damage the device.

- Centrifuges, rotors and accessories must not be cleaned in rinsing machines.
- They may only be cleaned by hand and disinfected with liquids.
- The water temperature must be between 20 – 25°C.
- Only detergents/disinfectants may be used which:
  - have a pH between 5 - 8
  - do not contain caustic alkalis, peroxides, chlorine compounds, acids and alkaline solutions
- In order to prevent appearances of corrosion through cleaning agents or disinfectants, the application guide from the manufacturer of the cleaning agent or disinfectant are absolutely to be heeded.

### 24.1 Centrifuge (housing, lid and centrifuging chamber)

#### 24.1.1 Surface cleaning and care

- Clean the centrifuge housing and the centrifuging chamber regularly, using soap or a mild detergent and a damp cloth if required. For one thing, this services purposes of hygiene, and it also prevents corrosion through adhering impurities.
- Ingredients of suitable detergents: soap, anionic tensides, non-ionic tensides.
- After using detergents, remove the detergent residue by wiping with a damp cloth.
- The surfaces must be dried immediately after cleaning.
- In the event of condensation water formation, dry the centrifugal chamber by wiping out with an absorbent cloth.
- Lightly rub the rubber seal of the centrifuge chamber with talcum powder or a rubber care product after each cleaning.
- The centrifuging chamber is to be checked for damage once a year.



If damage is found which is relevant to safety, the centrifuge may no longer be put into operation. In this case, notify Customer Service.

#### 24.1.2 Surface disinfection

- If infectious materials penetrates into the centrifugal chamber this is to be disinfected immediately.
- Ingredients of suitable disinfectants: ethanol, n-propanol, ethyl hexanol, anionic tensides, corrosion inhibitors.
- After using disinfectants, remove the disinfectant residue by wiping with a damp cloth.
- The surfaces must be dried immediately after disinfecting.

#### 24.1.3 Removal of radioactive contaminants

- The agent must be specifically labelled as being an agent for removing radioactive contaminants.
- Ingredients of suitable agents for removing radioactive contaminants: anionic tensides, non-ionic tensides, polyhydrated ethanol.
- After removing the radioactive contaminants, remove the agent residue by wiping with a damp cloth.
- The surfaces must be dried directly after removing the radioactive contaminants.

## 24.2 Rotors and Attachments

### 24.2.1 Cleaning and care

- In order to avoid corrosion and changes in materials, the rotors and accessories have to be cleaned regularly with soap or with a mild cleaning agent and a moist cloth. Cleaning is recommended at least once a week. Contaminants must be removed immediately.
- Ingredients of suitable detergents: soap, anionic tensides, non-ionic tensides.
- After using detergents, remove detergent residue by rinsing with water (only outside of the centrifuge) or wipe off with a damp cloth.
- The rotors and accessories must be dried directly after cleaning.
- Angle rotors, container and hanger made of aluminium are to be lightly greased after drying using acid-free grease, e.g. vaseline.
- The rotors and accessories have to be checked weekly for wear and corrosion.



Rotors and attachments may no longer be utilised upon indication of wear and tear or corrosion.

### 24.2.2 Disinfection

- If infectious material should get on the rotors or accessories, they must be appropriately disinfected.
- Ingredients of suitable disinfectants: ethanol, n-propanol, ethyl hexanol, anionic tensides, corrosion inhibitors.
- After using disinfectants, remove disinfectant residue by rinsing with water (only outside of the centrifuge) or wipe off with a damp cloth.
- The rotors and accessories must be dried directly after disinfection.

### 24.2.3 Removal of radioactive contaminants

- The agent must be specifically labelled as being an agent for the removal of radioactive contaminants.
- Ingredients of suitable agents for removing radioactive contaminants: anionic tensides, non-ionic tensides, polyhydrated ethanol.
- After removing the radioactive contaminants, remove agent residue by rinsing with water (only outside of the centrifuge) or wipe off with a damp cloth.
- The rotors and accessories must be dried directly after removing the radioactive contaminants.

### 24.2.4 Rotors and accessories with limited service lives

The use of certain rotors, hangers and accessory parts is limited by time.

These are marked with the maximum permitted number of operating cycles or with an expiration date and the maximum permitted number of operating cycles or just with the expiration date; e.g.:

- usable until end of month/year: 10/2024 ("usable until end of month/year: 10/2024")
- "max. cycles: 40000" (max. run cycles: 40000)



For safety reasons, rotors, hangers and accessory parts may no longer be used if either the indicated maximum number of operating cycles or the indicated expiration date has been reached.

The centrifuge is equipped with a cycle counter, which counts the running cycles (centrifugation runs) of the various rotor codes. For a description, see the "Cycle counter" chapter.

### 24.3 Autoclaving

The following accessory can be autoclaved at 121°C / 250°F (20 min):

- Swing-out rotors without hangers
- Reductions

No statement can be made about the degree of sterility.



Autoclaving accelerates the ageing process of plastics. In addition, autoclaving may discolour plastics.

### 24.4 Centrifuge containers

- With leakiness or after the breakage of centrifuging containers broken container parts and leaked centrifugation material are to be completely removed.
- The rubber inserts as well as the plastic sleeves of the rotors are to be replaced after a glass breakage.



Remaining glass splinters cause further glass breakage!

- If this concerns infectious material, a disinfection process is to be executed immediately.

## 25 Faults

If the fault cannot be eliminated with the help of the fault table, please inform Customer Service.

Please specify the type of centrifuge and the serial number. Both numbers can be found on the name plate of the centrifuge.



Perform a MAINS RESET:

- Switch off the mains switch (switch position "0").
- Wait at least 10 seconds and then switch on the mains switch again (switch position "1").

Message / fault		Cause	Remedy
No display		No voltage Mains input fuses defective.	<ul style="list-style-type: none"> <li>- Check distribution voltage.</li> <li>- Check mains power input fuse, refer to Chapter "Change mains input fuse".</li> <li>- Mains switch ON.</li> </ul>
IMBALANCE		The rotor is unevenly loaded.	<ul style="list-style-type: none"> <li>- Open the lid after the rotor is at a standstill.</li> <li>- Check the loading of the rotor, see chapter "Loading the rotor".</li> <li>- Repeat the centrifugation run.</li> </ul>
RPM > ROTOR MAX		Speed in the selected program greater than the maximum speed of the rotor.	<ul style="list-style-type: none"> <li>- Check the set speed.</li> <li>Reduce the set speed</li> </ul>
MAINS INTERRUPT		Power failure during the centrifugation run. (The centrifugation run was not finished.)	<ul style="list-style-type: none"> <li>- Open the lid after the rotor is at a standstill.</li> <li>- Push  button.</li> <li>- Repeat the centrifugation run if necessary.</li> </ul>
Rxxx WRONG ROTOR (xxx = Anzeige des Rotorcodes)		The used rotor is not approved for this device.	<ul style="list-style-type: none"> <li>- Use a rotor which is approved for this device.</li> </ul>
KEYBOARD ERROR		Error / defect electronics	<ul style="list-style-type: none"> <li>- Perform a MAINS RESET when the rotor has been stationary.</li> </ul>
TACHO ERROR	1, 2, 96.1	Failure of speed impulses during operation. No rotor inserted. Error / defect electronics	<ul style="list-style-type: none"> <li>- After the displayed waiting time expires (150 seconds), carry out a MAINS RESET.</li> <li>- Check whether the rotor is inserted.</li> </ul>
LID ERROR	4.1 – 4.127	Error in lid locking or lid closure.	<ul style="list-style-type: none"> <li>- Perform a MAINS RESET when the rotor has been stationary.</li> </ul>
OVER SPEED	5	Rotation too fast	
ROTOR ERROR	10.1 – 10.6	Incorrect rotor coding	
VERSION ERROR	12	Incorrect centrifuge model recognized. Error / defect electronics	
UNDER SPEED	13	Rotation too slow	



Message / fault		Cause	Remedy
CTRL ERROR	22 – 25.4	Error / defect electronics	– Perform a MAINS RESET when the rotor has been stationary.
CRC ERROR	27, 27.1		
COM ERROR	31 – 36		
FC ERROR	60, 61.1 – 61.21, 61.64 – 61.142		
TACHO ERR	61.22	Speed measurement error	– The device must not be switched off as long as the "wait" message is being displayed. After the message "wait ...!" is no longer displayed, carry out a MAINS RESET.
FC ERROR	61.23		
FC ERROR	61.153	Error / defect electronics	<ul style="list-style-type: none"> <li>– Perform a MAINS RESET.</li> <li>– Check the loading of the rotor, see chapter "Loading the rotor".</li> <li>– Repeat the centrifugation run.</li> </ul>
VERS. ERR	61.154	Invalid machine version	– Perform a MAINS RESET.

## 26 Change mains input fuses



Switch off the mains switch and separate the device from the mains!

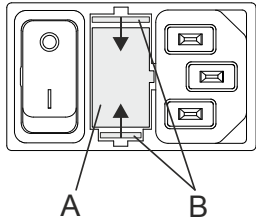

The fuse holder (A) with the mains input fuses is located next to the mains switch.

- Remove the connecting cable from the machine plug socket.
- Press the snap-fit (B) against the fuse holder (A) and remove.
- Exchange defective mains input fuses.



Only use fuses with the rating defined for the type. See the following table.

- Reinsert the fuse holder until the snap-fit clicks shut.
- Reconnect the device to the mains supply.

Model	Type	Fuse	Order no.
EBA 280	1101	T 3,15 AH/250V	E997
EBA 280 S	1102	T 3,15 AH/250V	E997
EBA 280	1101-01	T 6,3 AH/250V	2266
EBA 280 S	1102-01	T 6,3 AH/250V	2266

## 27 Returning Devices



Before returning the device, a transport securing device has to be installed.

If the device or its accessories are returned to Andreas Hettich GmbH & Co. KG, in order to provide protection for people, the environment and materials, it has to be decontaminated and cleaned before being shipped.

We reserve the right to refuse contaminated devices or accessories.

Costs incurred for cleaning and disinfection are to be charged to the customer.

We ask for your understanding in this matter.

## 28 Disposal

Before disposal, the device must be decontaminated and cleaned to protect people, the environment and property.

When you are disposing of the device, the respective statutory rules must be observed.

Pursuant to guideline 2002/96/EC (WEEE), all devices supplied after August 13, 2005 may not be disposed as part of domestic waste. The device belongs to group 8 (medical devices) and is categorized in the business-to-business field.



The icon of the crossed-out trash can shows that the device may not be disposed as part of domestic waste.

The waste disposal guidelines of the individual EC countries might vary. If necessary, contact your supplier.

## Table des matières

1	Utilisation de ce mode d'emploi .....	85
2	Signification des symboles.....	85
3	Utilisation conforme .....	86
4	Risques résiduels .....	86
5	Données techniques .....	87
6	Consignes de sécurité .....	88
7	Transport et stockage .....	89
7.1	Transport .....	89
7.2	Stockage.....	89
8	Etendue de la livraison.....	89
9	Retirer les dispositifs de sécurité pour le transport .....	90
10	Mise en service .....	90
11	Ouvrir et fermer le couvercle .....	91
11.1	Ouvrir le couvercle .....	91
11.2	Fermer le couvercle .....	91
12	Insérer et retirer le rotor.....	92
13	Chargement du rotor .....	93
14	Éléments de commande et d'affichage.....	94
14.1	Pictogrammes .....	94
14.2	Touches du champ de commande.....	94
14.3	Réglages possibles .....	95
15	Programmation.....	96
15.1	Entrer ou modifier des programmes.....	96
15.2	Appeler des programmes.....	98
15.3	Enregistrer les programmes.....	98
16	Centrifugation .....	99
16.1	Centrifugation avec présélection temps .....	99
16.2	Fonctionnement continu.....	100
16.3	Cycle de centrifugation court.....	101
17	Arrêt d'urgence .....	101
18	Reconnaissance du rotor .....	102
19	Compteur de cycles.....	103
20	Réglages et demandes .....	104
20.1	Demander des informations sur le système .....	105
20.2	Signal sonore .....	106
20.3	Signal optique à la fin du cycle de centrifugation .....	107
20.4	Déverrouillage automatique du couvercle après le cycle de centrifugation.....	108
20.5	Eclairage d'arrière-plan de l'affichage .....	109
20.6	Paramètres de centrifugation affichés après activation de l'appareil.....	110
20.7	Activer/désactiver la fonction "Dual time".....	111
20.8	Demander les heures de fonctionnement et le nombre de cycles de centrifugation .....	112
20.9	Remettre le compteur de cycles à zéro.....	113
21	Accélération centrifuge relative (RCF).....	114

22	Centrifugation de matières et de mélanges d'une densité supérieure à 1,2 kg/dm <sup>3</sup> .....	114
23	Déverrouillage de secours.....	114
24	Entretien et maintenance .....	115
24.1	Centrifugeuse (boîtier, couvercle et cuve) .....	115
24.1.1	Entretien et nettoyage des surfaces .....	115
24.1.2	Désinfection des surfaces.....	115
24.1.3	Décontamination de substances radioactives.....	115
24.2	Rotors et accessoires .....	116
24.2.1	Nettoyage et entretien .....	116
24.2.2	Désinfection .....	116
24.2.3	Décontamination de substances radioactives.....	116
24.2.4	Rotors et accessoires à durée d'utilisation limitée .....	116
24.3	Autoclavage .....	117
24.4	Réservoirs de centrifugation .....	117
25	Défauts.....	118
26	Changer les fusibles d'entrée de secteur .....	120
27	Renvoi d'appareils au fabricant .....	120
28	Élimination des déchets .....	120
29	Anhang / Appendix.....	160
29.1	Rotoren und Zubehör / Rotors and accessories.....	160

## 1 Utilisation de ce mode d'emploi

- Lisez et respectez impérativement les consignes et indications contenues dans le mode d'emploi avant d'utiliser la centrifugeuse.
- Le mode d'emploi fait partie intégrante de l'appareil. Vous devez le conserver de manière à toujours être à portée de main.
- Si vous changez l'appareil de place, le mode d'emploi doit suivre l'appareil.

## 2 Signification des symboles



Symbole sur l'appareil :

Attention, zone de danger général.

Avant utilisation de l'appareil, il est indispensable de lire le mode d'emploi et de respecter les consignes relatives à la sécurité!



Symbole dans ce document:

Attention, zone de danger général.

Ce symbole indique des consignes de sécurité et signale des situations pouvant être sources de danger. Le non-respect de ces instructions peut entraîner des dégâts matériels et personnels.



Symbole sur l'appareil et dans ce document:

Avertissement de menace biologique pour l'environnement.



Symbole dans ce document:

Ce symbole signale des informations importantes.



Symbole sur l'appareil :

Le symbole se trouve sur le boîtier, à proximité de la charnière.

Sens de rotation du rotor.



Symbole sur l'appareil :

Le symbole se trouve sur le devant du boîtier, sous l'ouverture.

Sens de rotation de la clé hexagonale pour le déverrouillage d'urgence du couvercle.



Symbole sur l'appareil et dans ce document:

Symbole pour la collecte séparée des appareils électriques et électroniques, conformément à la directive 2002/96(EG (WEEE). L'appareil fait partie du groupe 8 (appareils de médecine).

Utilisation dans les pays de l'Union Européenne ainsi qu'en Norvège et en Suisse.

### 3 Utilisation conforme

L'appareil dont il est question est un produit médical (centrifugeuse de laboratoire) dans l'esprit de la directive IVD 98/79/CE.

La centrifugeuse sert à la séparation de substances ou mélanges de substances d'une densité maximum de 1,2 kg/dm<sup>3</sup>, en particulier de prélèvements pour préparer le diagnostic in-vitro médical.

La détermination du potassium dans le sérum sanguin en fait partie spécialement. Le comportement lors du fonctionnement provoque une séparation minutieuse et empêche ainsi l'accumulation de potassium érythrocytaire supplémentaire dans le sérum. Cela permet d'empêcher une falsification des résultats des tests.

La centrifugeuse est exclusivement destinée à cette plage d'utilisation.

Toute utilisation en dehors ou au delà de ce cadre est considérée comme non conforme. L'entreprise Andreas Hettich GmbH & Co. KG décline toute responsabilité pour tout dommage en résultant.

L'utilisation conforme comprend également le respect de toutes les indications contenues dans le mode d'emploi et des travaux d'inspection et d'entretien.

Si la centrifugeuse est montée dans un autre appareil ou intégrée dans un système, c'est le fabricant du système complet qui est responsable de sa sécurité.

### 4 Risques résiduels

L'appareil est construit conformément au niveau actuel de la technologie et des règles de sécurité éprouvées. L'utilisation et la manipulation non conforme de cet appareil risquent de menacer la santé et l'intégrité corporelle de l'utilisateur ou de tierces personnes, ou de détériorer l'appareil ou autres biens matériels. Utilisez exclusivement l'appareil conformément à l'usage pour lequel il a été conçu et uniquement s'il est dans un état de fonctionnement technique irréprochable.

Remédier sans attendre à tout dérangement susceptible de porter atteinte à la sécurité.

## 5 Données techniques

Fabricant	Andreas Hettich GmbH & Co. KG D-78532 Tuttlingen			
Modèle	EBA 280		EBA 280 S	
Type	1101	1101-01	1102	1102-01
Tension du réseau ( $\pm 10\%$ )	200 - 240 V 1~	100 - 127 V 1~	200 - 240 V 1~	100 - 127 V 1~
Fréquence du réseau	50 - 60 Hz	50 - 60 Hz	50 - 60 Hz	50 - 60 Hz
Charge de connexion	185 VA	185 VA	330 VA	330 VA
Consommation de courant	0.85 A	1.75 A	1.6 A	3.0 A
Capacité max.	6 x 50 ml			
Densité admise	1.2 kg/dm <sup>3</sup>			
Vitesse de rotation (RPM)	6000			
Accélération (RCF)	4146		5031	
Energie cinétique	2700 Nm			
Obligation de contrôle (BGR 500)	non			
Conditions ambiantes (EN / IEC 61010-1)	<p>uniquement dans les intérieurs</p> <p>Jusqu'à 2000 m au dessus du niveau de la mer</p> <p>2°C à 40°C</p> <p>humidité de l'air max. relative 80% pour températures jusqu'à 31°C, décroissant en linéaire jusqu'à 50% de l'humidité relative pour 40°C.</p>			
– Emplacement				
– Hauteur				
– Température ambiante				
– Humidité de l'air				
– Catégorie de surtension (IEC 60364-4-443)	II			
– Degré d'encrassement	2			
Catégorie de protection de l'appareil	I			
Non approprié pour l'usage dans un environnement exposé aux explosions.				
EMV	EN / IEC 61326-1, catégorie B		FCC Class B	
– Emission de parasites, Résistance aux interférences	EN / IEC 61326-1, catégorie B		FCC Class B	
Niveau du bruit (en fonction du rotor)	$\leq 51$ dB(A)		$\leq 56$ dB(A)	
Dimensions				
– Largeur	326 mm			
– Profondeur	389 mm			
– Hauteur	242 mm			
Poids	env. 11 kg			

## 6 Consignes de sécurité



**Aucune demande garantie ne pourra être revendiquée auprès du fabricant si les indications données dans ce mode d'emploi ne sont pas toutes respectées.**



- **Veiller à la stabilité de la centrifugeuse.**
- **Avant d'utiliser la centrifugeuse, impérativement vérifier si le rotor est enclenché sur l'arbre moteur.**
- **Durant un processus de centrifugation, aucune personne, matière dangereuse et aucun objet ne doivent se trouver dans une zone de sécurité de 300 mm autour de la centrifugeuse selon EN / IEC 61010-2-020.**
- **Les rotors, balanciers et accessoires qui présentent d'importantes traces de corrosion ou des défauts mécaniques ou dont la durée d'utilisation a expiré ne doivent plus être utilisés.**
- **Suspendre immédiatement l'utilisation de la centrifugeuse si la cuve de centrifugeuse présente des dommages susceptibles de porter atteinte à la sécurité.**
- **Concernant les centrifugeuses sans réglage de température, il peut y avoir un réchauffement dans la cuve de centrifugeuse en cas de température ambiante élevée et/ou d'utilisation fréquente de l'appareil. Il n'est donc pas possible d'exclure une modification de l'échantillon due à la température.**

- **Il importe de lire et de respecter le mode d'emploi avant la mise en service de la centrifugeuse. Seules les personnes ayant lu et compris le mode d'emploi sont autorisées à manipuler l'appareil.**
- Outre le mode d'emploi et les réglementations contraignantes relatives à la prévention des accidents, il importe également de respecter les règles spécifiques et communément admises en matière de sécurité et de travail. Le mode d'emploi doit être complété des dispositions nationales applicables à la prévention des accidents et à la protection de l'environnement.
- La centrifugeuse a été construite conformément à l'état actuel de la technique et son fonctionnement est sûr. Elle peut cependant présenter des dangers pour l'utilisateur ou des tiers si son utilisation n'est pas confiée à un personnel dûment formé, est inadéquate ou non conforme à sa destination.
- Pendant le fonctionnement, la centrifugeuse ne devra pas être déplacée ou être heurtée.
- En cas de défaillance ou en cas de déverrouillage d'urgence, ne jamais intervenir dans l'appareil lorsque le rotor tourne.
- Afin d'éviter les dommages causés par la condensation en passant d'un local froid à un local chaud, il faut soit réchauffer la centrifugeuse en la laissant pendant au moins 3 heures dans le local chaud avant de la raccorder au secteur, soit la faire fonctionner pendant 30 minutes dans le local froid pour la chauffer.
- Pour cet appareil, vous ne devez utiliser que des rotors et des accessoires homologués par le fabricant (voir chapitre "Anhang/Appendix, Rotoren und Zubehör/Rotors and accessories"). Avant d'utiliser des récipients de centrifugation qui ne sont pas présentés dans le chapitre "Annexe/Appendix, rotors et accessoire/Rotors and accessories", l'utilisateur doit s'assurer auprès du fabricant qu'il peut les utiliser.
- Le rotor de la centrifugeuse doit uniquement être chargé conformément au chapitre "Chargement du rotor".
- Dans le cas de la centrifugation à la vitesse maximale, la densité des substances et des mélanges de substances ne doit pas excéder  $1,2 \text{ kg/dm}^3$ .
- Il est interdit de procéder à des centrifugations en présence de défauts d'équilibrage.
- La centrifugeuse ne doit pas être exploitée dans un environnement explosif.
- Il est interdit de procéder à des centrifugations :
  - avec des matières inflammables ou explosives,
  - avec des matières susceptibles de réagir chimiquement ou de dégager d'importantes quantités d'énergie.
- En cas de centrifugation de substances dangereuses ou de substances mixtes toxiques, radioactives ou contaminées par des micro-organismes pathogènes, il incombe à l'utilisateur de prendre les mesures ad hoc. Il faut systématiquement utiliser des récipients de centrifugation avec des bouchons spéciaux à vis destinés aux substances dangereuses. Dans le cas des substances des groupes de risques 3 et 4, il faut utiliser un système



de sécurité biologique en plus des récipients de centrifugation pouvant être obturés (voir le manuel "Laboratory Biosafety Manual" publié par l'Organisation Mondiale de la Santé).  
 Cette centrifugeuse ne dispose pas de système de sécurité biologique.

- Il est interdit de centrifuger des matières fortement corrosives pouvant réduire la résistance mécanique des rotors, des supports et des accessoires.
- Les réparations ne peuvent être effectuées que par une personne autorisée à cet effet par le fabricant.
- Utiliser uniquement les pièces de rechange originales et les accessoires d'origine homologués par les Etablissements Andreas Hettich GmbH & Co. KG.
- Les dispositions de sécurité suivantes font foi :  
 EN / IEC 61010-1 et EN / IEC 61010-2-020 ainsi que les dérogations nationales.
- La sécurité et la fiabilité de la centrifugeuse seront uniquement garanties si :
  - la centrifugeuse est utilisée conformément aux instructions du mode d'emploi,
  - l'installation électrique du site de la centrifugeuse est conforme aux prescriptions EN / IEC,
  - les contrôles prescrits dans les différents pays en matière de sécurité de l'appareil, par ex. en Allemagne selon BGV A1 et BGR 500 sont effectués par un professionnel.

## 7 Transport et stockage

### 7.1 Transport



Installer le dispositif de sécurité pour le transport avant de transporter l'appareil.

Respecter les conditions ambiantes suivantes pour transporter l'appareil et ses accessoires :

- Température ambiante : -20°C à +60°C
- Humidité relative de l'air : 20% à 80%, non condensante

### 7.2 Stockage



Ne stocker l'appareil et ses accessoires que dans une pièce fermée au sec.

Respecter les conditions ambiantes suivantes pour stocker l'appareil et ses accessoires :

- Température ambiante : -20°C à +60°C
- Humidité relative de l'air : 20% à 80%, non condensante

## 8 Etendue de la livraison

Les accessoires suivants sont fournis avec la centrifugeuse:

- 1 câble de raccordement
- 2 fusibles
- 1 clé mâle six-pans
- 1 mode d'emploi
- 1 fiche de notes concernant la sécurité du transport
- 1 fiche de notes concernant le déverrouillage de secours

Le(s) rotor(s) et accessoires correspondant sont livrés selon les spécifications de la commande.

## 9 Retirer les dispositifs de sécurité pour le transport



Retirez impérativement les dispositifs de sécurité pour le transport.

Conservez ces dispositifs de sécurité afin de les réutiliser lors du transport ultérieur de l'appareil (leur montage est obligatoire).

Le transport de l'appareil est exclusivement autorisé avec les dispositifs de sécurité correspondants.

Pour protéger l'appareil pendant le transport, on fixe le moteur.

Retirez impérativement ces dispositifs de sécurité pour le transport avant la mise en service de l'appareil.

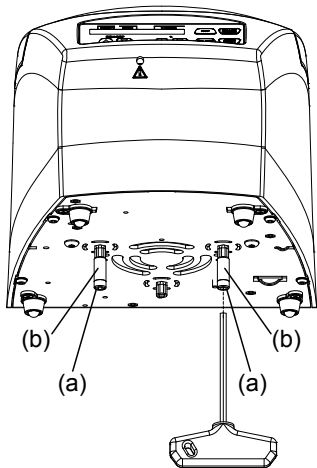

- Enlevez les deux vis (a) et douilles d'écartement (b).



Pour remonter les dispositifs de sécurité pour le transport, procédez dans l'enchaînement inverse.

## 10 Mise en service

- Retirez les dispositifs de sécurité pour le transport au fond du boîtier, voir chapitre "Retirer les dispositifs de sécurité pour le transport".
- **Placer la centrifugeuse sur un emplacement approprié de manière à ce qu'elle soit stable et mettre de niveau. Lors de la mise en place, il faut respecter la zone de sécurité exigée de 300mm autour de la centrifugeuse selon EN / IEC 61010-2-020.**



**Durant un processus de centrifugation, aucune personne, matière dangereuse et aucun objet ne doivent se trouver dans une zone de sécurité de 300 mm autour de la centrifugeuse selon EN / IEC 61010-2-020.**

- Ne pas placer d'objet devant la grille de ventilation.  
Ménager un espace de ventilation de 300 mm autour de la grille.
- Vérifier que la tension de secteur est identique à la mention de la plaque signalétique.
- Raccorder la centrifugeuse à une prise de secteur normalisée au moyen du câble de connexion. Puissance connectée voir chapitre "Données techniques".
- Allumer l'interrupteur de réseau (position du commutateur "I"). Les LEDs s'allument brièvement. Vous voyez s'afficher successivement :
  1. le modèle de centrifugeuse
  2. le numéro type et la version du programme
  3. le code du rotor (R) et la vitesse maximale de rotation du rotor (maxRPM) qui a été reconnu en dernier par la reconnaissance du rotor
  4. les paramètres de centrifugation du dernier programme utilisé ou du programme 1



Quand le couvercle est fermé, le message "Open the lid" s'affiche.  
Dans ce cas, ouvrir le couvercle pour afficher les paramètres de centrifugation.

## 11 Ouvrir et fermer le couvercle

### 11.1 Ouvrir le couvercle



Vous ne pouvez ouvrir le couvercle que si la centrifugeuse est en marche et le rotor à l'arrêt. Si cela n'est pas possible, consulter le chapitre "Déverrouillage d'urgence".



Si le compteur de cycles est activé, le nombre de cycles de centrifugation restants s'affiche brièvement, après un cycle de centrifugation, pendant l'ouverture du couvercle.

Exemple :

PROG	RCF<	RPM	t/min:s
RemCycles= 16703			



- Appuyer sur la touche. Le couvercle se déverrouille de manière motorisée.  
 : couvercle déverrouillé.  
 La DEL gauche de la touche s'éteint.

Exemple :

PROG	RCF<	RPM	t/min:s
1	6	4500	5:00

### 11.2 Fermer le couvercle



Ne pas mettre les doigts entre le couvercle et le boîtier.  
 Ne pas fermer le couvercle violemment.

- Poser le couvercle et appuyer légèrement sur le bord avant du couvercle. Le couvercle se verrouille de manière motorisée.  
 : couvercle verrouillé.

La DEL gauche de la touche  brille.

Exemple :

PROG	RCF<	RPM	t/min:s
1	6	4500	5:00

## 12 Insérer et retirer le rotor

### Rotor avec bouton de déverrouillage

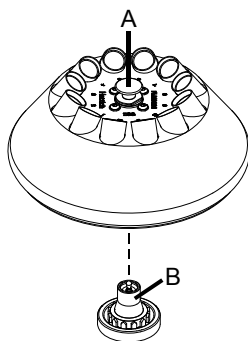

#### Insérer le rotor :



La présence d'impuretés entre l'arbre moteur et le rotor empêche au rotor d'avoir une position parfaite, et provoque un fonctionnement irrégulier du rotor.

Si besoin est, nettoyer l'arbre moteur (B) et le moyeu du rotor avant d'insérer le rotor.

- Soulever le rotor au bouton de déverrouillage (A) et le poser à l'horizontale sur l'arbre moteur (B). Le rotor s'enclenche automatiquement sur l'arbre moteur.
- Tenir le rotor à gauche et à droite, et tirer légèrement vers le haut pour vérifier s'il est bien enclenché sur l'arbre moteur.

#### Retirer le rotor :

- Tirer le bouton de déverrouillage (A) du rotor vers le haut, bien tenir et ôter le rotor de l'arbre moteur.

### Rotor sans bouton de déverrouillage

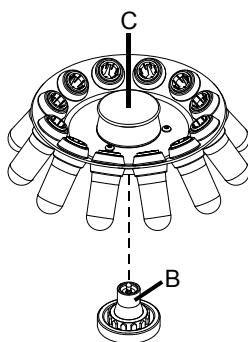

#### Insérer le rotor :



La présence d'impuretés entre l'arbre moteur et le rotor empêche au rotor d'avoir une position parfaite, et provoque un fonctionnement irrégulier du rotor.

Si besoin est, nettoyer l'arbre moteur (B) et le moyeu du rotor avant d'insérer le rotor.

- Soulever le rotor sur la poignée (C), le poser à l'horizontale sur l'arbre moteur (B) et appuyer dessus jusqu'à la butée.

#### Retirer le rotor :

- Bien tenir le rotor à la poignée (C) et l'ôter de l'arbre moteur.

### 13 Chargement du rotor



Des récipients standard de centrifugation en verre sont résistants jusqu' à un ACR de 4000 (DIN 58970, partie 2).

- Tenir le rotor à gauche et à droite, et tirer légèrement vers le haut pour vérifier s'il est bien enclenché sur l'arbre moteur.
- Dans le cas des rotors à balanciers, toutes les positions des rotors doivent être équipées avec les **mêmes** balanciers.
- Le chargement des rotors et des balanciers doit être nécessairement symétrique. Les conteneurs de centrifugation doivent être uniformément répartis sur toutes les positions du rotor. Pour les combinaisons possibles, voir le Chapitre "Anhang/Appendix, Rotoren und Zubehör/Rotors and accessories". Dans le cas des rotors à angle fixe, il faut charger tous les logements possibles du rotor, voir au chapitre "Annexe/Appendix, Rotors et accessoires/Rotors and accessories".

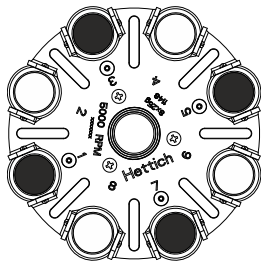

Rotor uniformément chargé

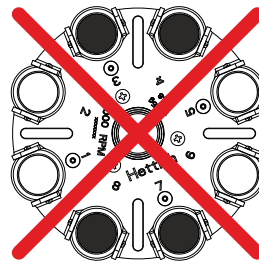

**Non autorisé !**

Rotor irrégulièrement chargé

- Dans le cas des récipients à garniture de caoutchouc, les récipients de centrifugation doivent avoir le même nombre de garnitures dans la partie inférieure.
- Remplissez les réservoirs de centrifugation uniquement en dehors de la centrifugeuse.
- La quantité maximale de remplissage indiquée par le fabricant pour les récipients de centrifugation ne doit pas être dépassée.

Pour les rotors angulaires, remplir les réservoirs de centrifugation de sorte que du liquide ne puisse pas être projeté à l'extérieur pendant le cycle de centrifugation

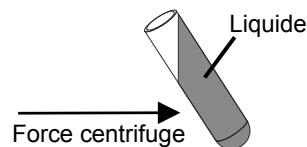

- Aucun fluide ne doit pénétrer dans les rotors angulaires et dans la cuve de centrifugeuse lors du chargement des rotors angulaires.
- Pendant le chargement de la suspension des balanciers, et pendant le balancement de la suspension dans le cycle de centrifugation, aucun fluide ne doit pénétrer dans la cuve de centrifugeuse..
- La hauteur de remplissage des récipients sera autant que possible égale pour maintenir les différences de poids entre les récipients de centrifugation aussi réduites que possible.
- Le poids du volume de remplissage autorisé est indiqué sur chaque rotor. Il est interdit de dépasser cette tare.

## 14 Éléments de commande et d'affichage



### 14.1 Pictogrammes



Couvercle déverrouillé.



Couvercle verrouillé.



Affichage de la rotation. L'affichage de rotation brille en tournant dans le sens inverse des aiguilles d'une montre tant que le rotor tourne.

### 14.2 Touches du champ de commande



- Appeler des programmes
- Enregistrer les programmes.



- Passer de l'affichage RPM (RPM) à l'affichage RCF (>RCF<) et inversement. Les valeurs RCF s'affichent entre parenthèses ><. La LED située au-dessus de la touche brille quand l'affichage RCF est sélectionné.
- RPM: Vitesse de rotation  
RCF : Accélération centrifuge relative



- Touche de sélection de chaque paramètre. Chaque pression supplémentaire de la touche permet de sélectionner le paramètre suivant.
- Appeler "MACHINE MENU" (appuyer sur la touche pendant 8 secondes).
- Dans "Machine Menu", sélectionner les menus "→ Info", "→ Settings" et "→ Time & Cycles".
- Faire défiler les menus vers l'avant.



- Modifier la valeur d'un paramètre sélectionné auparavant. Pour faire défiler plus rapidement les valeurs, maintenez la touche enfoncée.



- Lancer le cycle de centrifugation. La LED dans la touche brille au cours d'un cycle de centrifugation tant que le rotor tourne.
- Cycle de centrifugation court. Le cycle de centrifugation tourne tant que vous appuyez la touche. La LED dans la touche brille au cours d'un cycle de centrifugation tant que le rotor tourne.
- Enregistrer les données et les modifications.
- Appeler les menus "→ Info", "→ Settings" et "→ Time & Cycles".



- Terminer le cycle de centrifugation. Le rotor s'arrête avec le niveau de freinage présélectionné. La LED à droite dans la touche brille jusqu'à ce que le rotor soit arrêté. La LED à gauche dans la touche brille une fois que le rotor est arrêté. Appuyer deux fois sur la touche pour déclencher l'arrêt d'urgence.
- Déverrouiller le couvercle. La DEL gauche de la touche s'éteint.

### 14.3 Réglages possibles

**PROG RCL Emplacement de programme devant être appelé.**

Vous pouvez appeler les emplacements de programme 1 à 9 et #.

**t/min** **Durée de fonctionnement.** Réglable de 1 à 99 min, en étapes de 1 minute.

**t/sec** **Durée de fonctionnement.** Réglable de 1 à 59 s, en étapes de 1 seconde.

**Fonctionnement continu "--:--".** Mettre les paramètres **t/min** et **t/sec** sur zéro.

**Begins at** **Compter la durée du cycle.**

**START** La durée du cycle commence à compter immédiatement après le démarrage du cycle de centrifugation.

**Begins at** La durée du cycle commence à compter seulement une fois la vitesse de rotation programmée atteinte.  
**SPEED**



Vous ne pouvez régler ce paramètre que si la fonction "Dual time" est activée, voir chapitre "Activer/désactiver la fonction Dual time". La fonction a été activée en usine.

**RPM** **Vitesse de rotation**

Vous pouvez saisir une valeur numérique pour paramétrer un régime de 200 RPM jusqu'à vitesse maximum du rotor.

Réglable par pas de 10.

Vitesse maximum du rotor, voir chapitre "Annexe/Appendix, rotors et accessoires/Rotors and accessories".

**RAD/mm** **Rayon de centrifugation**

Réglable de 10 mm à 330 mm, en étapes de 1 millimètre.

Rayon de centrifugation, voir chapitre "Annexe/Appendix, rotors et accessoires/Rotors and accessories".



La saisie du rayon de centrifugation n'est possible que si l'affichage RCF (>RCF<) est sélectionné.

**RCF** **Accélération centrifuge relative**

Vous pouvez saisir une valeur numérique pour paramétrer un régime de 200 RPM jusqu'à vitesse maximum du rotor.

Réglable par pas de 1.



La saisie des données pour l'accélération centrifuge relative (RCF) n'est possible que si l'affichage RCF (>RCF<) est sélectionné.

L'accélération centrifuge relative (RCF) dépend du rayon de centrifugation (RAD).

L'accélération relative de la centrifugeuse (RCF) et le rayon de centrifugation programmé (RAD) s'affichent.



Etages de montée en puissance de 1 à 9. Etage 9 = temps de montée en puissance le plus court, étage 1 = temps de montée en puissance le plus long.



Etages de décélération de 0 à 9. Etage 9 = temps de décélération le plus court, étage 1 = étage de décélération long, étage 0 = étage de décélération le plus long (décélération par inertie, sans freinage).

**PROG STO** **Emplacement sur lequel enregistrer le programme.**

Il est possible d'enregistrer 9 programmes (emplacements de programme 1 à 9).



Ne pas enregistrer de programmes sur l'emplacement #.

L'emplacement de programme # sert à enregistrer provisoirement les paramètres de centrifugation modifiés.

Les paramètres de centrifugation sur l'emplacement de programme # sont écrasés chaque fois qu'un cycle de centrifugation est exécuté avec des paramètres modifiés qui n'ont pas été enregistrés.

## 15 Programmation



Ne pas enregistrer de programmes sur l'emplacement #.

L'emplacement de programme # sert à enregistrer provisoirement les paramètres de centrifugation modifiés.

Si vous ne confirmez pas l'enregistrement des paramètres de centrifugation modifiés sur un emplacement de programme, l'écran affichera alors un tiret "-" au lieu du numéro de l'emplacement de programme. Après démarrage du cycle de centrifugation, ces paramètres de centrifugation sont automatiquement enregistrés sur l'emplacement de programme #.

Les paramètres de centrifugation sur l'emplacement de programme # sont écrasés chaque fois qu'un cycle de centrifugation est exécuté avec des paramètres modifiés qui n'ont pas été enregistrés.

### 15.1 Entrer ou modifier des programmes



Pour tourner en fonctionnement continu il faut mettre les paramètres **t/min** et **t/sec** sur zéro. L'affichage temps (t/min:s) indique "--:--".

Exemple:

PROG	>RCF<	RPM	t/min:s
1		4500	--:--

L'accélération centrifuge relative (RCF) dépend du rayon de centrifugation (RAD). Le calcul n'est correct que si le rayon de centrifugation est correctement configuré. Pendant la saisie des données de l'accélération RCF, le rayon de centrifugation configuré s'affiche.

Exemple:

PROG	>RCF<	RPM	t/min:s
R: 126	RCF=	2853	

Affichage et saisie de l'accélération centrifuge relative (RCF) et du rayon de centrifugation (RAD) ne sont possibles que si vous avez sélectionné l'affichage correspondant (>RCF<).

Si, après ou pendant la saisie de paramètres, vous n'appuyez pas de touche pendant 8 secondes, les paramètres précédents réapparaissent. Vous devez alors recommencer la saisie des paramètres.

Vous pouvez à tout moment interrompre la saisie des paramètres en appuyant la touche . Auquel cas, les réglages ne seront pas enregistrés.



- Appuyer la touche. **PROG RCL**: emplacement de programme pour les paramètres de centrifugation affichés.

Exemple:  
affichage RPM (RPM)

PROG	>RCF<	RPM	t/min:s
PROG RCL =		2	

Exemple:  
affichage RCF (>RCF<)

PROG	>RCF<	RPM	t/min:s
PROG RCL =		2	



- Avec ces touches, configurer l'emplacement de programme dont il faut afficher les paramètres de centrifugation.

PROG	>RCF<	RPM	t/min:s
PROG RCL =		1	

PROG	>RCF<	RPM	t/min:s
PROG RCL =		1	



- Appuyer la touche. Les paramètres de centrifugation s'affichent.

PROG	>RCF<	RPM	t/min:s
*** OK ***			

PROG	>RCF<	RPM	t/min:s
*** OK ***			

PROG	>RCF<	RPM	t/min:s
1		4500	5:00

PROG	>RCF<	RPM	t/min:s
1	>	2853<	5:00



Suite page suivante





- Au besoin, appuyez la touche pour sélectionner l'affichage RPM (RPM) ou l'affichage RCF (>RCF<). La LED située au-dessus de la touche brille quand l'affichage (>RCF<) est sélectionné.



- Appuyer sur la touche jusqu'à ce que le paramètre de centrifugation souhaité s'affiche.  
Exemple: **t/min** : durée de fonctionnement, minutes.



- Réglez la valeur souhaitée avec les touches.



- Saisir successivement tous les paramètres de centrifugation souhaités.



- Appuyer sur la touche jusqu'à affichage de l'écran suivant.  
**PROG STO**: emplacement du programme où sauvegarder les paramètres de centrifugation.



- Avec ces touches, configurer l'emplacement de programme souhaité.



- Appuyer la touche.  
Les paramètres de centrifugation sont ensuite enregistrés sur l'emplacement du programme.

### Exemple: affichage RPM (RPM)

PROG	>RCF<	RPM	U/min.s
1	▣	4500	5:00

PROG	>RCF<	RPM	U/min.s
t/min		=05:00	

PROG	>RCF<	RPM	U/min.s
t/min		=04:00	

PROG	>RCF<	RPM	U/min.s
t/sec		=04:30	

PROG	>RCF<	RPM	U/min.s
PROG STO	=	1	

PROG	>RCF<	RPM	U/min.s
PROG STO	=	3	

PROG	>RCF<	RPM	U/min.s
*** OK ***			

PROG	>RCF<	RPM	U/min.s
3	▣	4500	4:30

### Exemple: affichage RCF (>RCF<)

PROG	>RCF<	RPM	U/min.s
1	▣>	2853<	5:00

PROG	>RCF<	RPM	U/min.s
t/min		=05:00	

PROG	>RCF<	RPM	U/min.s
t/min		=04:00	

PROG	>RCF<	RPM	U/min.s
t/sec		=04:30	

PROG	>RCF<	RPM	U/min.s
PROG STO	=	1	

PROG	>RCF<	RPM	U/min.s
PROG STO	=	3	

PROG	>RCF<	RPM	U/min.s
*** OK ***			

PROG	>RCF<	RPM	U/min.s
3	▣>	2853<	4:30

## 15.2 Appeler des programmes



- Appuyer la touche.  
**PROG RCL**: emplacement de programme pour les paramètres de centrifugation affichés.



- Avec ces touches, configurer l'emplacement de programme dont il faut afficher les paramètres de centrifugation.



- Appuyer la touche.  
Les paramètres de centrifugation s'affichent.

Exemple:  
affichage RPM (RPM)

PROG	>RCF<	RPM	t/min:s
PROG	RCL	=	2

Exemple:  
affichage RCF (>RCF<)

PROG	>RCF<	RPM	t/min:s
PROG	RCL	=	2

PROG	>RCF<	RPM	t/min:s
PROG	RCL	=	1

PROG	>RCF<	RPM	t/min:s
PROG	RCL	=	1

PROG	>RCF<	RPM	t/min:s
***	OK	***	

PROG	>RCF<	RPM	t/min:s
***	OK	***	

PROG	>RCF<	RPM	t/min:s
1	⊞	4500	5:00

PROG	>RCF<	RPM	t/min:s
1	⊞	> 2853<	5:00

## 15.3 Enregistrer les programmes



- Appuyer la touche deux fois.  
**PROG STO**: emplacement du programme où sauvegarder les paramètres de centrifugation.



- Avec les touches, configurer l'emplacement de programme sur lequel enregistrer les paramètres de centrifugation.



- Appuyer la touche.  
Les paramètres de centrifugation sont ensuite enregistrés sur l'emplacement du programme.

Exemple:  
affichage RPM (RPM)

PROG	>RCF<	RPM	t/min:s
PROG	STO	=	3

Exemple:  
affichage RCF (>RCF<)

PROG	>RCF<	RPM	t/min:s
PROG	STO	=	3

PROG	>RCF<	RPM	t/min:s
PROG	STO	=	1

PROG	>RCF<	RPM	t/min:s
PROG	STO	=	1

PROG	>RCF<	RPM	t/min:s
***	OK	***	

PROG	>RCF<	RPM	t/min:s
***	OK	***	

PROG	>RCF<	RPM	t/min:s
1	⊞	4500	5:00

PROG	>RCF<	RPM	t/min:s
1	⊞	> 2853<	5:00

## 16 Centrifugation



Pendant un cycle de centrifugation, conformément à la norme européenne/ IEC 61010-2-020, veuillez à ce que personne, ni substance dangereuse ni objet, ne se trouve dans la zone de sécurité de 300 mm autour de la centrifugeuse.



Après chaque cycle de centrifugation, pendant le déverrouillage du couvercle, le nombre de cycles de centrifugation restants s'affiche brièvement.

Exemple:



En cas de dépassement de la différence de poids autorisée pendant le chargement du rotor, le cycle de centrifugation s'arrête au démarrage et le message suivant s'affiche:



Vous pouvez à tout moment interrompre un cycle de centrifugation en appuyant la touche .

Vous pouvez sélectionner et modifier les paramètres de centrifugation pendant un cycle de centrifugation. Enregistrement des valeurs modifiées sur emplacement de programme #.

Avec la touche , vous pouvez à tout moment commuter entre l'affichage RPM (RPM) et l'affichage RCF (>RCF<). Pour travailler avec l'affichage RCF (>RCF<), il faut saisir les données du rayon de centrifugation.

Si le message suivant s'affiche,



cela signifie que vous ne pourrez continuer à utiliser la centrifugeuse qu'après ouverture du couvercle.

Erreurs de commande et dérangements s'affichent (voir chapitre "Dérangements").

- Allumer l'interrupteur de réseau. Position du commutateur I.
- Charger le rotor et fermer le couvercle de la centrifugeuse.

### 16.1 Centrifugation avec présélection temps



- Au besoin, appuyez la touche pour sélectionner l'affichage RPM (RPM) ou l'affichage RCF (>RCF<). La LED située au-dessus de la touche brille quand l'affichage (>RCF<) est sélectionné.



- Saisir les paramètres de centrifugation souhaités (voir chapitre "Programmation").



- Appuyer la touche. Le cycle de centrifugation démarre. Pendant le cycle de centrifugation, l'écran affiche la vitesse de rotation du rotor ou la valeur RCF en résultant, ainsi que le temps restant.



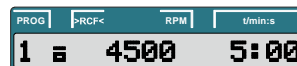

Suite page suivante

Exemple:  
affichage RPM (RPM)

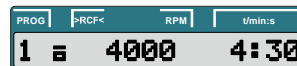

Exemple:  
affichage RCF (>RCF<)



- A échéance du temps paramétré ou en cas d'arrêt du cycle de centrifugation avec la touche , l'arrêt se déclenche avec le niveau de freinage paramétré. Le niveau de freinage s'affiche. Exemple 

## 16.2 Fonctionnement continu



- Au besoin, appuyez la touche pour sélectionner l'affichage RPM (RPM) ou l'affichage RCF (>RCF<). La LED située au-dessus de la touche brille quand l'affichage (>RCF<) est sélectionné.



- Saisir les paramètres de centrifugation souhaités. Mettre les paramètres **t/min** et **t/sec** sur zéro (voir chapitre "Programmation").



- Appuyer la touche. Le cycle de centrifugation démarre. Pendant le cycle de centrifugation, l'écran affiche la vitesse de rotation du rotor ou la valeur RCF en résultant, ainsi que le temps écoulé.



- Appuyer la touche. Le cycle de centrifugation s'arrête. L'arrêt se déroule avec le niveau de freinage réglé. Le niveau de freinage s'affiche. Exemple 

### Exemple: affichage RPM (RPM)



### Exemple: affichage RCF (>RCF<)



### Exemple: affichage RPM (RPM)



### Exemple: affichage RCF (>RCF<)



### 16.3 Cycle de centrifugation court



- Au besoin, appuyez la touche pour sélectionner l'affichage RPM (RPM) ou l'affichage RCF (>RCF<). La LED située au-dessus de la touche brille quand l'affichage (>RCF<) est sélectionné.



- Saisir les paramètres de centrifugation souhaités (voir chapitre "Programmation").



- Appuyer la touche et maintenez la enfoncée.  
Pendant le cycle de centrifugation, l'écran affiche la vitesse de rotation du rotor ou la valeur RCF en résultant, ainsi que le temps écoulé.



- Relâcher la touche.  
Le cycle de centrifugation s'arrête.  
L'arrêt se déroule avec le niveau de freinage réglé. Le niveau de freinage s'affiche. Exemple  $\sim\sim 7$ .

#### Exemple: affichage RPM (RPM)



#### Exemple: affichage RCF (>RCF<)



### 17 Arrêt d'urgence



- Appuyer la touche deux fois.  
En cas d'arrêt d'urgence, le système s'arrête avec le niveau de freinage 9 (temps d'arrêt le plus court). Le niveau de freinage  $\sim\sim 9$  s'affiche.

#### Exemple: affichage RPM (RPM)



#### Exemple: affichage RCF (>RCF<)



## 18 Reconnaissance du rotor

La centrifugeuse est équipée d'une reconnaissance automatique du rotor.

Après démarrage de chaque cycle de centrifugation, le système exécute un cycle de reconnaissance du rotor.

A la première lecture du code d'un rotor par le système de reconnaissance du rotor, le cycle de centrifugation s'arrête automatiquement après reconnaissance du rotor. Le code du rotor (R) et la vitesse maximum (maxRPM) du rotor autorisée pour cette centrifugeuse s'affichent.

Exemple:



Après arrêt du rotor (la LED gauche de la touche  brille), appuyer n'importe quelle touche. Le nombre maximum de cycles autorisés pour le rotor s'affiche.

Exemple:



Il faut maintenant configurer le nombre maximum de cycles autorisés pour le rotor respect. la suspension (voir chapitre "Compteur de cycles").

En cas d'utilisation d'un rotor dont le code a déjà été mémorisé par la reconnaissance du rotor, sa vitesse maximum autorisée (ROTOR MAX) pour cette centrifugeuse s'affiche brièvement après démarrage du cycle de centrifugation.

Exemple:



Si la vitesse réglée est supérieure à la vitesse maximum de rotor autorisée pour cette centrifugeuse, le cycle de centrifugation s'arrête après reconnaissance du rotor et les messages suivants s'affichent en alternance:

Exemple:



Dans ce cas, il faut vérifier la vitesse de rotation affichée et l'ajuster sur la vitesse maximum du rotor.

## 19 Compteur de cycles



La durée d'utilisation de certains rotors et suspensions est limitée sur un nombre maximum de cycles de centrifugation. Les rotors et suspensions correspondants sont spécifiés par le nombre maximum de cycles autorisés.

La centrifugeuse est équipée d'un compteur qui compte les cycles de centrifugation des différents codes du rotor (voir également chapitre "Reconnaissance du rotor").

Après chaque cycle de centrifugation, pendant le déverrouillage du couvercle, le nombre de cycles de centrifugation restants s'affiche brièvement.

Exemple:



Lorsque le nombre maximum de cycles autorisés pour le rotor est atteint, l'écran affiche le message suivant à chaque démarrage d'un cycle de centrifugation, et vous devez relancer le cycle.



Si le message s'affiche



remplacer immédiatement le rotor, respect. les suspensions concernées par un rotor neuf, respect. une suspension neuve, pour des raisons de sécurité.

Après remplacement du rotor, respect. de la suspension, il faut remettre le compteur de cycles du code-rotor correspondant sur zéro (voir chapitre "Remettre compteur de cycles à zéro").

À la première lecture du code d'un rotor par le système de reconnaissance du rotor, le cycle de centrifugation s'arrête automatiquement après reconnaissance du rotor. Le code du rotor (R) et la vitesse maximum (maxRPM) du rotor autorisée pour cette centrifugeuse s'affichent.

Puis il faut ajuster le nombre maximum de cycles autorisés pour le rotor respect. la suspension.



Pour les rotors libres, il faut toujours régler le nombre maximum de cycles autorisés pour la suspension.

Configurer le nombre maximum de cycles autorisés pour le rotor, respect. la suspension, en procédant comme suit:

### Exemple:

Affichage après reconnaissance du rotor.

**R:** code du rotor.

**maxRPM:** vitesse maximum de rotor autorisée pour cette centrifugeuse.



Appuyer n'importe quelle touche.

- Patienter jusqu'à ce que la LED gauche



de la touche brille.

- Appuyer n'importe quelle touche. Le nombre maximum de cycles autorisés s'affiche.



Suite page suivante

**Exemple:**

- Vérifier si le nombre maximum de cycles autorisés affiché concorde avec les données du rotor, respect. des suspensions.

PROG | >RCF< | RPM | | u/min.s  
Cyc lim=< 50000>

Dans le cas contraire, configurer le nombre maximum de cycles autorisés en fonction des données spécifiées pour le rotor, respect. les suspensions.

- ☞ Pour les rotors et suspensions dont la durée d'utilisation n'est pas limitée à un nombre maximum de cycles de centrifugation, il faut les mettre sur zéro.



- Ajuster la valeur correcte avec les touches.

PROG | >RCF< | RPM | | u/min.s  
Cyc lim=< 50000>



- Appuyer la touche. Enregistrement du nombre maximum de cycles autorisés.

PROG | >RCF< | RPM | | u/min.s  
1 4500 5:00

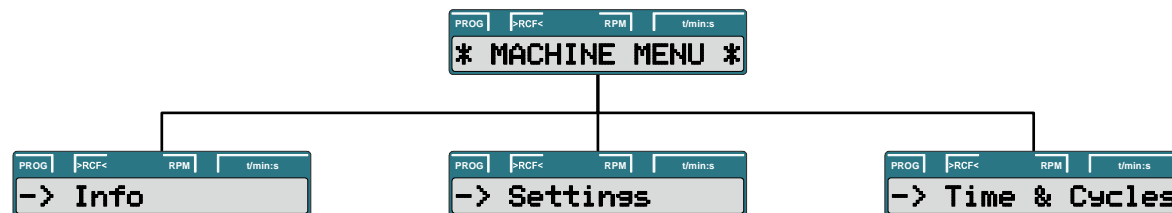
**20 Réglages et demandes****Demande:**

- Informations système (chapitre 20.1)

**Réglage:**

- Signal sonore (chapitre 20.2)
- Déverrouillage automatique du couvercle après le cycle de centrifugation (chapitre 20.4)
- Désactivation automatique de l'éclairage d'arrière-plan (chapitre 20.5)
- Signal optique à la fin du cycle de centrifugation (chapitre 20.3)
- Paramètres de centrifugation affichés après enclenchement de l'appareil (chapitre 20.6)
- Activer/désactiver la fonction "Dual time" (chapitre 20.7)

**Demande:**

- Heures de fonctionnement (chapitre 20.8)
- Nombre de cycles de centrifugation exécutés (chapitre 20.8)

**Réglage:**

- Compteur de cycles (chapitre 20.9)





## 20.1 Demander des informations sur le système

Vous pouvez demander les informations-système suivantes:

- modèle de centrifugeuse,
- vitesses maximum des différents codes-rotor,
- version du programme de la centrifugeuse,
- type du convertisseur de fréquence,
- version du programme du convertisseur de fréquence

Lorsque le rotor est à l'arrêt, procédez comme suit pour vos demandes d'informations:

 Vous pouvez à tout moment interrompre la procédure en appuyant la touche .



- Appuyer la touche pendant 8 secondes.

PROG | >RCF< | RPM | U/min.s  
\* MACHINE MENU \*



- Appuyer la touche.

PROG | >RCF< | RPM | U/min.s  
-> Info



- Appuyer la touche.  
Modèle de centrifugeuse

PROG | >RCF< | RPM | U/min.s  
EBA 280

PROG | >RCF< | RPM | U/min.s  
EBA 280S



- Appuyer la touche.  
**R**: code du rotor.  
**\***: le code du rotor en cours d'utilisation est signalé par une étoile.  
**RPMmax**: vitesse maximum de rotor autorisée pour cette centrifugeuse.

Exemple:

PROG | >RCF< | RPM | U/min.s  
R 3\*RPMmax 5000



- avec les touches, vous pouvez afficher les vitesses maximum des différents codes-rotor.

Exemple:

PROG | >RCF< | RPM | U/min.s  
R 10 RPMmax 6000



- Appuyer la touche.  
Version du programme de la centrifugeuse.

Exemple:

PROG | >RCF< | RPM | U/min.s  
CP FW= V01.00



- Appuyer la touche.  
Type du convertisseur de fréquence.

Exemple:

PROG | >RCF< | RPM | U/min.s  
FC type LC 300VA



- Appuyer la touche.  
Version du programme du convertisseur de fréquence.

Exemple:

PROG | >RCF< | RPM | U/min.s  
FC FW= D1.01



- Appuyer deux fois la touche pour quitter le menu "-> Info" ou trois fois pour quitter le "\*MACHINE MENU\*".

PROG | >RCF< | RPM | U/min.s  
\* MACHINE MENU \*

Exemple:

PROG | >RCF< | RPM | U/min.s  
1 4 4500 5:00



## 20.2 Signal sonore























Le signal sonore retentit:

- en intervalles de 2 secondes en cas de dérangement.
- en intervalles de 30 secondes une fois le cycle de centrifugation terminé et le rotor arrêté.

Appuyer n'importe quelle touche pour arrêter le signal sonore.

Lorsque le rotor est à l'arrêt, vous pouvez régler le signal sonore en procédant comme suit :

 Vous pouvez à tout moment interrompre la procédure en appuyant la touche . Auquel cas, les réglages ne seront pas enregistrés.

	• Appuyer la touche pendant 8 secondes.		
↓			
	• Appuyer sur la touche jusqu'à affichage de l'écran suivant.		
↓			
	• Appuyer la touche. <b>End beep</b> : Signal sonore à la fin du cycle de centrifugation. <b>off</b> : signal désactivé. <b>on</b> : signal activé.		
↓			
	• Paramétrer avec les touches <b>off</b> (Arrêt) ou <b>on</b> (Marche).		
↓			
	• Appuyer la touche. <b>Error beep</b> : signal sonore dès apparition d'un dérangement. <b>off</b> : signal désactivé. <b>on</b> : signal activé.		
↓			
	• Paramétrer avec les touches <b>off</b> (Arrêt) ou <b>on</b> (Marche).		
↓			
	• Appuyer la touche. <b>Beep volume</b> : volume du signal sonore. <b>min</b> : bas <b>mid</b> : moyen <b>max</b> : fort		
↓			
	• Paramétrer avec les touches <b>min</b> , <b>mid</b> , ou <b>max</b> .		
↓			
			

↓  
Suite page suivante



- Appuyer la touche pour enregistrer le réglage.



- Appuyer cette touche une fois pour quitter le menu  
"-> Settings" ou deux fois pour quitter le  
"\* MACHINE MENU \*".



Exemple:



### 20.3 Signal optique à la fin du cycle de centrifugation

A la fin du cycle de centrifugation, l'éclairage en arrière-plan de l'affichage clignote pour vous signaler optiquement que le cycle de centrifugation est terminé.

Lorsque le rotor est à l'arrêt, vous pouvez activer ou désactiver le signal optique comme suit:



Vous pouvez à tout moment interrompre la procédure en appuyant la touche



- Appuyer la touche pendant 8 secondes.



- Appuyer sur la touche jusqu'à affichage de l'écran suivant.



- Appuyer la touche.



- Appuyer sur la touche jusqu'à affichage de l'un des deux écrans.  
**End blinking** : clignotement de l'éclairage d'arrière-plan après le cycle de centrifugation.  
**off** : l'éclairage d'arrière-plan ne clignote pas.  
**on** : l'éclairage d'arrière-plan clignote.



- Paramétrer avec les touches **off** (Arrêt) ou **on** (Marche).



- Appuyer la touche pour enregistrer le réglage.



- Appuyer cette touche une fois pour quitter le menu  
"-> Settings" ou deux fois pour quitter le  
"\* MACHINE MENU \*".



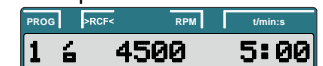

Exemple:





















## 20.4 Déverrouillage automatique du couvercle après le cycle de centrifugation

Vous pouvez paramétrer si le couvercle doit se déverrouiller automatiquement ou pas après le cycle de centrifugation.

Lorsque le rotor est à l'arrêt, vous pouvez procéder comme suit pour ce faire:



 Vous pouvez à tout moment interrompre la procédure en appuyant la touche . Auquel cas, les réglages ne seront pas enregistrés.



















	<ul style="list-style-type: none"> <li>Appuyer la touche pendant 8 secondes.</li> </ul>		
↓			
	<ul style="list-style-type: none"> <li>Appuyer sur la touche jusqu'à affichage de l'écran suivant.</li> </ul>		
↓			
	<ul style="list-style-type: none"> <li>Appuyer la touche.</li> </ul>		
↓			
	<ul style="list-style-type: none"> <li>Appuyer sur la touche jusqu'à affichage de l'un des deux écrans.  <b>Lid AutoOpen</b> : déverrouillage automatique du couvercle après le cycle de centrifugation.  <b>off</b> : pas de déverrouillage automatique du couvercle.  <b>on</b> : déverrouillage automatique du couvercle.</li> </ul>		
↓			
	<ul style="list-style-type: none"> <li>Paramétrer avec les touches <b>off</b> ou <b>on</b>.</li> </ul>		
↓			
	<ul style="list-style-type: none"> <li>Appuyer la touche pour enregistrer le réglage.</li> </ul>		
↓			
↓			
	<ul style="list-style-type: none"> <li>Appuyer cette touche une fois pour quitter le menu            "-&gt; Settings" ou deux fois pour quitter le menu            "* MACHINE MENU *".</li> </ul>		<p>Exemple:</p> 

## 20.5 Eclairage d'arrière-plan de l'affichage

Pour économiser de l'énergie, vous pouvez paramétrer si, après un cycle de centrifugation, l'éclairage d'arrière-plan de l'affichage doit s'éteindre au bout de 2 minutes.

Lorsque le rotor est à l'arrêt, vous pouvez procéder comme suit pour ce faire:



 Vous pouvez à tout moment interrompre la procédure en appuyant la touche . Auquel cas, les réglages ne seront pas enregistrés.

	• Appuyer la touche pendant 8 secondes.		
↓			
	• Appuyer sur la touche jusqu'à affichage de l'écran suivant.		
↓			
	• Appuyer la touche.		
↓			
	• Appuyer sur la touche jusqu'à affichage de l'un des deux écrans. <b>Power save</b> : arrêt automatique de l'éclairage d'arrière-plan. <b>off</b> : arrêt automatique désactivé. <b>on</b> : arrêt automatique activé.		
↓			
	• Paramétrer avec les touches <b>off</b> (Arrêt) ou <b>on</b> (Marche).		
↓			
	• Appuyer la touche pour enregistrer le réglage.		
↓			
↓			
	• Appuyer cette touche une fois pour quitter le menu "-> Settings" ou deux fois pour quitter le "* MACHINE MENU *".		Exemple: 

## 20.6 Paramètres de centrifugation affichés après activation de l'appareil

Après activation de l'appareil, les paramètres de centrifugation du dernier programme utilisé ou du programme 1 s'affichent.

Lorsque le rotor est à l'arrêt, vous pouvez procéder comme suit pour ce faire:

 Vous pouvez à tout moment interrompre la procédure en appuyant la touche . Auquel cas, les réglages ne seront pas enregistrés.

- 

• Appuyer la touche pendant 8 secondes.

- ↓





• Appuyer sur la touche jusqu'à affichage de l'écran suivant.

- ↓





• Appuyer la touche.



- ↓

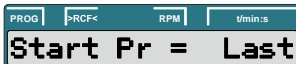



• Appuyer sur la touche jusqu'à affichage de l'un des deux écrans.  
**Start Pr:** programme affiché après activation.  
**First:** programme 1.  
**Last:** dernier programme utilisé .



- ↓





• Régler **First** ou **Last** avec les touches.



- ↓



• Appuyer la touche pour enregistrer le réglage.



- ↓



• Appuyer cette touche une fois pour quitter le menu  
"-> Settings" ou deux fois pour quitter le  
"\* MACHINE MENU \*".





Exemple:





















## 20.7 Activer/désactiver la fonction "Dual time"

Pour régler la durée de marche (paramètre **Begins at START** et paramètre **Begins at SPEED**), la fonction "Dual time" doit être activée. La fonction a été activée en usine.

Lorsque le rotor est à l'arrêt, vous pouvez procéder comme suit pour ce faire:

 Vous pouvez à tout moment interrompre la procédure en appuyant la touche . Auquel cas, les réglages ne seront pas enregistrés.

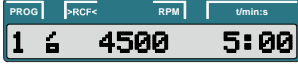
 ↓  ↓  ↓  ↓  ↓  ↓ 	<ul style="list-style-type: none"> <li>• Appuyer la touche pendant 8 secondes.</li> <li>• Appuyer sur la touche jusqu'à affichage de l'écran suivant.</li> <li>• Appuyer la touche.</li> <li>• Appuyer sur la touche jusqu'à affichage de l'un des deux écrans. <b>Dual time:</b> Compter la durée du cycle. <b>on</b> : Fonction activée. <b>off</b> : Fonction désactivée.</li> <li>• Paramétrer avec les touches <b>off</b> (Arrêt) ou <b>on</b> (Marche).</li> <li>• Appuyer la touche pour enregistrer le réglage.</li> <li>• Appuyer cette touche une fois pour quitter le menu "<b>-&gt; Settings</b>" ou deux fois pour quitter le "<b>* MACHINE MENU *</b>".</li> </ul>	                 <b>Exemple:</b> 
---	--	--



## 20.8 Demander les heures de fonctionnement et le nombre de cycles de centrifugation

Les heures de fonctionnement sont réparties en heures de service internes et externes.

Heures de service internes: durée totale pendant laquelle l'appareil était enclenché.

Heures de service externes: durée totale des cycles de centrifugation effectués jusque maintenant.

Lorsque le rotor est à l'arrêt, procédez comme suit pour vos demandes d'informations:

 Vous pouvez à tout moment interrompre la procédure en appuyant la touche .



- Appuyer la touche pendant 8 secondes.

PROG | >RCF< | RPM | t/min:s  
\* MACHINE MENU \*



- Appuyer sur la touche jusqu'à affichage de l'écran suivant.

PROG | >RCF< | RPM | t/min:s  
-> Time & Cycles



- Appuyer la touche.  
**TimeExt** : heures de service externes.

Exemple:

PROG | >RCF< | RPM | t/min:s  
TimeExt= 1543 h



- Appuyer la touche.  
**TimeInt** : heures de service internes.

Exemple:

PROG | >RCF< | RPM | t/min:s  
TimeInt= 1760 h



- Appuyer la touche.  
**Starts** : nombre total des cycles de centrifugation.

Exemple:

PROG | >RCF< | RPM | t/min:s  
Starts = 8325



- Appuyer la touche deux fois pour quitter le menu "-> Time & Cycles" ou trois fois pour quitter le "\* MACHINE MENU \*".

PROG | >RCF< | RPM | t/min:s  
\* MACHINE MENU \*

Exemple:

PROG | >RCF< | RPM | t/min:s  
1 6 4500 5:00



## 20.9 Remettre le compteur de cycles à zéro

Après remplacement du rotor, respect. de la suspension, il faut remettre le compteur de cycles pour le code du rotor correspondant sur zéro.



Ne remettez le compteur de cycles à zéro qu'après remplacement du rotor, respect. de la suspension, par un rotor neuf, respect. une nouvelle suspension.

Lorsque le rotor est à l'arrêt, vous pouvez réinitialiser le compteur de cycles comme suit:



Vous pouvez à tout moment interrompre la procédure en appuyant la touche . Auquel cas, les réglages ne seront pas enregistrés.



- Appuyer la touche pendant 8 secondes.



- Appuyer sur la touche jusqu'à affichage de l'écran suivant.



- Appuyer la touche.

Exemple:



- Appuyer sur la touche jusqu'à affichage de l'écran suivant.  
**Cyc sum** : nombre de cycles effectués.



- Appuyer la touche.



- Appuyer la touche.  
Remise à zéro du nombre de cycles effectués.



- Appuyer la touche pour enregistrer le réglage.



- Appuyer la touche deux fois pour quitter le menu "-> Time & Cycles" ou trois fois pour quitter le "\* MACHINE MENU \*".



Exemple:



## 21 Accélération centrifuge relative (RCF)

L'accélération centrifuge relative (RCF) est indiquée en tant que multiple de l'accélération gravitationnelle (g). Il s'agit d'une valeur dépourvue d'unité, qui sert à la comparaison entre la puissance de séparation et de sédimentation.

Le calcul s'effectue à l'aide de la formule suivante:

$$RCF = \left( \frac{RPM}{1000} \right)^2 \times r \times 1,118 \quad \Rightarrow \quad RPM = \sqrt{\frac{RCF}{r \times 1,118}} \times 1000$$

RCF = accélération centrifuge relative

RPM = régime

r = rayon de centrifugation en mm = distance qui sépare le centre de l'axe de rotation du fond de la cuve de centrifugation. Rayon de centrifugation voir chapitre "Anhang/Appendix, Rotoren und Zubehör/Rotors and accessories".



L'accélération centrifuge relative (RCF) est dépendante du régime et du rayon de centrifugation.

## 22 Centrifugation de matières et de mélanges d'une densité supérieure à 1,2 kg/dm<sup>3</sup>

Dans le cas de la centrifugation à la vitesse maximale, la densité des substances et des mélanges de substances ne doit pas excéder 1,2 kg/dm<sup>3</sup>. Réduire la vitesse de rotation pour les matières et mélanges ayant une densité supérieure.

La vitesse de rotation autorisée se calcule de la manière suivante:

$$\text{Vitesse de centrifugation lente (n}_{red}\text{)} = \sqrt{\frac{1,2}{\text{densité supérieure [kg/dm}^3\text{]}}} \times \text{Vitesse de rotation maximum [RPM]}$$

Exemple: Vitesse de rotation maximum RPM 4000, densité 1,6 kg/dm<sup>3</sup>

$$n_{red} = \sqrt{\frac{1,2 \text{ kg/dm}^3}{1,6 \text{ kg/dm}^3}} \times 4000 \text{ RPM} = 3464 \text{ RPM}$$

En cas d'incertitude, prendre contact avec le fabricant.

## 23 Déverrouillage de secours

En cas de panne de courant, il est impossible de déverrouiller le couvercle par voie moteur. Il faut donc procéder à un déverrouillage de secours manuel.



Pour un déverrouillage de secours, débranchez la centrifugeuse du réseau.  
N'ouvrez le couvercle que si le rotor est à l'arrêt.



**PRUDENCE!** Lors du déverrouillage de secours, si vous tournez la clé six-pans dans le sens des aiguilles d'une montre (à droite), vous endommagez le verrou.  
Ne tournez la clé six-pans que dans le sens inverse des aiguilles d'une montre (vers la gauche), voir illustration.

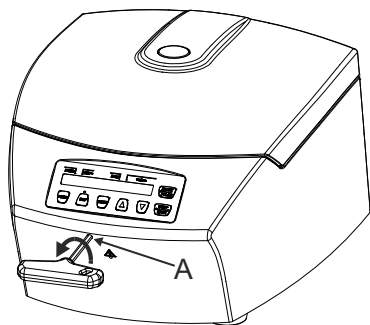

- Débranchez la tension du réseau en mettant l'interrupteur en position "0".
- Vérifiez par la fenêtre du couvercle que le rotor est bien à l'arrêt.
- Insérez la clé six-pans à l'horizontale dans l'ouverture A et tournez-la avec précaution dans le sens inverse des aiguilles d'une montre (vers la gauche) jusqu'à ouverture du couvercle.
- Retirez la clé six-pans de l'ouverture.

## 24 Entretien et maintenance



L'appareil est peut-être contaminé.



Retirer la prise de secteur avant de nettoyer.

Avant d'utiliser une procédure de nettoyage ou de décontamination autre que celle recommandée par le fabricant, l'utilisateur vérifiera auprès du fabricant que la procédure prévue n'endommage pas l'appareil.

- Ne pas nettoyer centrifuges, rotors et accessoires dans un lave-vaisselle.
- Seul le nettoyage manuel et une désinfection liquide sont autorisés.
- La température de l'eau doit être située entre 20 et 25°C.
- Utiliser exclusivement des agents de nettoyage ou de désinfection qui :
  - ont un pH de 5 à 8,
  - ne contiennent pas de substances caustiques, de peroxyde, composés chlorés, acides ni alcalins.
- Respecter impérativement les consignes spéciales d'utilisation données par le fabricant des agents de nettoyage et de désinfection, afin de prévenir la corrosion par les agents de nettoyage et de désinfection.

### 24.1 Centrifugeuse (boîtier, couvercle et cuve)

#### 24.1.1 Entretien et nettoyage des surfaces

- Nettoyer régulièrement le boîtier de la centrifugeuse et le compartiment de centrifugation et les laver en cas de besoin avec du savon ou un détergent doux et un chiffon humide. Ces opérations sont nécessaires pour garantir l'hygiène et pour prévenir la corrosion par la présence durable d'impuretés.
- Substances des nettoyeurs adéquats :  
savon, agents anioniques et non ioniques.
- Après utilisation des nettoyeurs, enlevez les résidus en essuyant l'appareil avec un chiffon humide.
- Séchez immédiatement les surfaces après nettoyage.
- Sécher le bol avec un chiffon absorbant en cas de dépôt d'eau de condensation dans le bol de la centrifugeuse.
- Frotter légèrement le joint d'étanchéité en caoutchouc du compartiment de centrifugation, après chaque nettoyage, avec de la poudre de talc ou un produit d'entretien pour caoutchouc.
- Vérifiez tous les ans le bon état de la cuve.



N'utilisez plus la centrifugeuse si elle présente des dommages susceptibles de porter atteinte à la sécurité. Auquel cas, contactez le service après-vente.

#### 24.1.2 Désinfection des surfaces

- Le bol de la centrifugeuse doit être nettoyé immédiatement dans le cas où un matériau infectieux a pénétré dans le bol de la centrifugeuse.
- Substances des désinfectants adéquats :  
éthanol, n-propanol, éthylènehexanol, agents anioniques, inhibiteurs de corrosion.
- Après utilisation de désinfectants, enlevez les résidus en essuyant l'appareil avec un chiffon humide.
- Séchez immédiatement les surfaces après désinfection.

#### 24.1.3 Décontamination de substances radioactives

- L'agent employé doit expressément convenir pour une décontamination de substances radioactives.
- Substances des agents adaptés à une décontamination des substances radioactives :  
agents anioniques, non ioniques agents, éthanol polyhydre.
- Après décontamination des substances radioactives, enlevez les résidus en essuyant l'appareil avec un chiffon humide.
- Séchez immédiatement les surfaces après décontamination des substances radioactives.

## 24.2 Rotors et accessoires

### 24.2.1 Nettoyage et entretien

- Afin de prévenir la corrosion et toute modification des matériaux, il faut nettoyer régulièrement les rotors et les accessoires avec du savon ou un détergent doux et un chiffon humide. Il est vivement recommandé d'effectuer un nettoyage au moins une fois par semaine. Enlevez immédiatement les impuretés.
- Substances des nettoyeurs adéquats :  
savon, agents anioniques et non ioniques.
- Après utilisation de nettoyeurs, enlevez les résidus en rinçant à l'eau claire (uniquement à l'extérieur de la centrifugeuse) ou en essuyant les surfaces avec un chiffon humide.
- Séchez rotors et accessoires immédiatement après nettoyage.
- Après séchage, les rotors d'angle, les réservoirs et la suspension en aluminium seront enduits d'une pellicule de graisse sans acide, par exemple la vaseline.
- Vérifier une fois par semaine l'état des rotors et des accessoires afin de détecter les éventuelles détériorations issues de l'usure et l'oxydation.



Les rotors et les accessoires usés et endommagés par la corrosion ne doivent plus être utilisés.

### 24.2.2 Désinfection

- Si les rotors ou accessoires sont infectés, procédez à une désinfection appropriée.
- Substances des désinfectants adéquats :  
éthanol, n-propanol, éthylènehexanol, agents anioniques, inhibiteurs de corrosion.
- Après utilisation de désinfectants, enlevez les résidus en rinçant à l'eau claire (uniquement à l'extérieur de la centrifugeuse) ou en essuyant les surfaces avec un chiffon humide.
- Séchez rotors et accessoires immédiatement après désinfection.

### 24.2.3 Décontamination de substances radioactives

- L'agent employé doit expressément convenir pour une décontamination de substances radioactives.
- Substances des agents adaptés à une décontamination des substances radioactives :  
agents anioniques, agents non ioniques, éthanol polyhydre.
- Après décontamination des substances radioactives, enlevez les résidus en rinçant à l'eau claire (uniquement à l'extérieur de la centrifugeuse) ou en essuyant les surfaces avec un chiffon humide.
- Séchez immédiatement rotors et accessoire après décontamination des substances radioactives.

### 24.2.4 Rotors et accessoires à durée d'utilisation limitée

L'utilisation de certains rotors, balanciers et accessoires est limitée dans le temps.

Ces limites sont indiquées par le nombre maximum de cycles ou la date limite d'utilisation et le nombre maximum de cycles, ou simplement la date limite d'utilisation, par ex. :

- usable until end of month/year: 10/2024" (utilisation autorisée jusqu'à la fin du mois/année: 10/2024)
- max. cycles: 40000" (nombre max. de cycles: 40000)



Pour des raisons de sécurité, l'utilisation de rotors, balanciers et accessoires n'est plus autorisée dès que le nombre maximum de cycles désigné ou la date limite d'utilisation inscrite sont atteints.

La centrifugeuse est équipée d'un compteur qui compte les cycles de centrifugation des différents codes-rotor. Description voir chapitre "Compteur de cycles".

### 24.3 Autoclavage

Les matériels suivants peuvent être autoclavés à 121° C / 250° F (20 min) :

- Rotors libres sans suspension
- Réducteurs

Le degré de stérilité ne peut pas être indiqué.



L'autoclavage provoque l'accélération du vieillissement des plastiques et peut provoquer des décolorations des plastiques.

### 24.4 Réservoirs de centrifugation

- En cas de fuite ou de rupture de récipients de centrifugation, il faut éliminer tous les morceaux de récipients cassés, les fragments de verre et les substances centrifugées écoulées.
- Les amortisseurs antivibrations ainsi que les caoutchouc intermédiaires des rotors doivent être remplacés après un bris de verre.



Les fragments de verre restants peuvent entraîner d'autres bris de verre !

- S'il s'agit d'un matériau infectieux, exécuter immédiatement une désinfection.

## 25 Défaits

Si l'erreur ne peut pas être éliminée d'après le tableau des défauts, il faut alors avertir le service après-vente. Veuillez indiquer le type de centrifuge et le numéro de série. Les deux numéros sont indiqués sur la plaque signalétique de la centrifugeuse.



Effectuer une RÉINITIALISATION DU SECTEUR :

- Couper l'interrupteur de secteur (position de l'interrupteur "0").
- Attendre au moins 10 secondes et refermer ensuite l'interrupteur de secteur (position de l'interrupteur "I").

Message / Erreur		Origine	Solution
Pas d'affichage		Pas de tension Défaut des fusibles sur l'entrée de secteur.	<ul style="list-style-type: none"> <li>- Vérifier l'alimentation en tension.</li> <li>- Vérifier les fusibles d'entrée du secteur, voir au chapitre "Changer les fusibles d'entrée de secteur".</li> <li>- Interrupteur du secteur sur MARCHE</li> </ul>
IMBALANCE		Le rotor est chargé de manière non symétrique.	<ul style="list-style-type: none"> <li>- Ouvrez le couvercle lorsque le rotor est arrêté.</li> <li>- Vérifier le chargement du rotor, voir au chapitre "Chargement du rotor".</li> <li>- Répéter le cycle de centrifugation.</li> </ul>
RPM > ROTOR MAX		Vitesse de rotation paramétrée dans le programme sélectionné supérieure à la vitesse maximale de rotation du rotor.	<ul style="list-style-type: none"> <li>- Vérifier la vitesse du programme sélectionnée</li> <li>- Corriger la vitesse du programme sélectionnée .</li> </ul>
MAINS INTERRUPT		Interruption du secteur pendant le cycle de centrifugation. (Le cycle de centrifugation n'est pas terminé.)	<ul style="list-style-type: none"> <li>- Ouvrez le couvercle lorsque le rotor est arrêté.</li> <li>- Appuyer sur la touche .</li> <li>- En cas de besoin, répéter le cycle de centrifugation.</li> </ul>
Rxxx WRONG ROTOR (xxx = Anzeige des Rotorcodes)		Le rotor utilisé n'est pas autorisé pour cet appareil.	<ul style="list-style-type: none"> <li>- Insérer un rotor autorisé pour cet appareil.</li> </ul>
KEYBOARD ERROR		Défaut / Panne de l'électronique.	<ul style="list-style-type: none"> <li>- Effectuer une RÉINITIALISATION DU SECTEUR après l'immobilisation du rotor.</li> </ul>
TACHO ERROR	1, 2, 96.1	Défaillance des impulsions de rotation pendant une opération. Pas de rotor inséré. Défaut / Panne de l'électronique.	<ul style="list-style-type: none"> <li>- Après écoulement du temps d'attente affiché (150 secondes), réinitialiser le réseau (NETZ-RESET).</li> <li>- Vérifier si le rotor est inséré.</li> </ul>
LID ERROR	4.1 – 4.127	Erreur du verrouillage ou de la fermeture du capot.	<ul style="list-style-type: none"> <li>- Effectuer une RÉINITIALISATION DU SECTEUR après l'immobilisation du rotor.</li> </ul>
OVER SPEED	5	Survitesse	
ROTOR ERROR	10.1 – 10.6	Erreur codage du rotor	
VERSION ERROR	12	Modèle de centrifugeuse détecté incorrect. Défaut / Panne de l'électronique.	
UNDER SPEED	13	Vitesse trop basse	

Message / Erreur		Origine	Solution
CTRL ERROR	22 – 25.4	Défaut / Panne de l'électronique.	– Effectuer une RÉINITIALISATION DU SECTEUR après l'immobilisation du rotor.
CRC ERROR	27, 27.1		
COM ERROR	31 – 36		
FC ERROR	60, 61.1 – 61.21, 61.64 – 61.142		
TACHO ERR	61.22	Vitesse de rotation mesurée erronée	– Ne pas éteindre l'appareil tant que le message d'invitation à attendre "Wait" est affiché. Lorsque le message d'invitation à attendre ""wait ...!" n'est plus affiché, réinitialiser le réseau (NETZ-RESET).
FC ERROR	61.23		
FC ERROR	61.153	Défaut / Panne de l'électronique.	– Effectuer une RÉINITIALISATION DU SECTEUR. – Vérifier le chargement du rotor, voir au chapitre "Chargement du rotor". – Répéter le cycle de centrifugation..
VERS. ERR	61.154	Version de machine non valide	– Effectuer une RÉINITIALISATION DU SECTEUR.

## 26 Changer les fusibles d'entrée de secteur



Déclencher l'interrupteur de secteur et couper l'appareil du réseau!

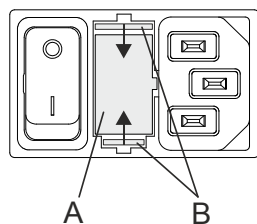

Le porte-fusible (A) avec les fusibles d'entrée de secteur se trouve à côté de l'interrupteur secteur.

- Retirer le câble de raccordement de la prise d'appareil.
- Appuyer la fermeture rapide (B) contre le porte-fusible (A) et extraire celui-ci.
- Remplacer les fusibles d'entrée du réseau défectueux.



N'utilisez que des fusibles avec la valeur nominale, fixée pour le type, voir tableau suivant.

- Remettre en place le porte-fusible et pousser jusqu'à encastrement de la fermeture rapide.
- Rebrancher l'appareil sur le réseau.

Modèle	Type	Fusible	N° de commande
EBA 280	1101	T 3,15 AH/250V	E997
EBA 280 S	1102	T 3,15 AH/250V	E997
EBA 280	1101-01	T 6,3 AH/250V	2266
EBA 280 S	1102-01	T 6,3 AH/250V	2266

## 27 Renvoi d'appareils au fabricant



Avant de renvoyer l'appareil, il faut monter le dispositif de fixation pour le transport.

Dans le cas où l'appareil ou ses accessoires doivent être retournés à la société Andreas Hettich GmbH & Co. KG, il faut les décontaminer et les nettoyer avant expédition, dans le but d'assurer la protection des personnes, de l'environnement et du matériel.

Nous nous réservons le droit de refuser des appareils ou des accessoires contaminés.

Nous facturons au client les frais de nettoyage et de désinfection.

Vous voudrez bien manifester votre compréhension pour cette réglementation.

## 28 Élimination des déchets

Avant de mettre l'appareil au rebut, vous devez le décontaminer et le nettoyer pour la protection des personnes, de l'environnement et du matériel.

Les dispositions légales en vigueur doivent être respectées lors de l'élimination de l'appareil.

Conformément à la directive 2002/96/CE (WEEE), tous les appareils livrés après le 13.08.2005 ne doivent plus être jetés avec les déchets ménagers. L'appareil fait partie du groupe 8 (dispositifs médicaux) et est classé dans le domaine "Business-to-Business".



Le symbole de la poubelle barrée d'une croix indique que l'appareil ne doit pas être jeté avec les déchets ménagers.

Les dispositions relatives à l'élimination des déchets des différents pays de l'UE peuvent varier. Veuillez-vous adresser en cas de besoin à votre fournisseur.



**Indice**

1	Impiego di queste istruzioni per l'uso .....	123
2	Significato dei simboli .....	123
3	Conformità di impiego .....	124
4	Rischi residui .....	124
5	Dati tecnici .....	125
6	Indicazioni inerenti la sicurezza .....	126
7	Trasporto ed immagazzinaggio .....	127
7.1	Trasporto .....	127
7.2	Immagazzinaggio .....	127
8	Entità di fornitura .....	127
9	Rimuovere il dispositivo di sicurezza per il trasporto .....	128
10	Messa in funzione .....	128
11	Aprire e chiudere il coperchio .....	129
11.1	Aprire il coperchio .....	129
11.2	Chiudere il coperchio .....	129
12	Installazione ed estrazione del rotore .....	130
13	Carico del rotore .....	131
14	Elementi di comando e di visualizzazione .....	132
14.1	Simboli esposti .....	132
14.2	Tasti del campo di comando .....	132
14.3	Possibilità di regolazione .....	133
15	Programmazione .....	134
15.1	Immettere o modificare i dati .....	134
15.2	Richiamare i programmi .....	136
15.3	Memorizzare programmi .....	136
16	Centrifugazione .....	137
16.1	Centrifugazione con preselezione del tempo .....	137
16.2	Funzionamento continuo .....	138
16.3	Centrifugazione breve .....	139
17	Arresto di Emergenza .....	139
18	Riconoscimento rotore .....	140
19	Contatore cicli .....	141
20	Impostazioni e consultazioni .....	143
20.1	Consultare informazioni di sistema .....	144
20.2	Segnale acustico .....	145
20.3	Segnale ottico dopo la fine del processo di centrifugazione .....	146
20.4	Sbloccaggio automatico del coperchio dopo il processo di centrifugazione .....	147
20.5	Illuminazione di sfondo della videata .....	148
20.6	Parametro di centrifugazione indicato dopo l'inserimento dell'apparecchiatura .....	149
20.7	Attivare/ disattivare funzione "Dual time" .....	150
20.8	Consultazione delle ore di funzionamento e della quantità di processi di centrifugazione .....	151
20.9	Resettare su zero il contatore cicli .....	152
21	Accelerazione centrifuga relativa (RCF) .....	153

22	Centrifugazione di sostanze o di miscele di sostanze con densità maggiore di 1,2 kg/dm <sup>3</sup> .....	153
23	Sbloccaggio di emergenza .....	153
24	Pulizia e manutenzione .....	154
24.1	Centrifughe (scatola, coperchio e vano di centrifugazione) .....	154
24.1.1	Cura e pulizia delle superfici .....	154
24.1.2	Disinfezione delle superfici .....	154
24.1.3	Rimuovere contaminazioni radioattive .....	154
24.2	Rotori ed accessori .....	155
24.2.1	Pulizia e cura .....	155
24.2.2	Disinfezione .....	155
24.2.3	Rimuovere contaminazioni radioattive .....	155
24.2.4	Rotori ed accessori con limitata durata di impiego.....	155
24.3	Mantenere in autoclave.....	156
24.4	Contenitori centrifuga.....	156
25	Guasti.....	157
26	Sostituzione fusibili entrata rete .....	158
27	Rispedizione di apparecchi .....	159
28	Smaltimento .....	159
29	Anhang / Appendix.....	160
29.1	Rotoren und Zubehör / Rotors and accessories.....	160

## 1 Impiego di queste istruzioni per l'uso

- Prima della messa in funzione della centrifuga leggere ed osservare le istruzioni per l'uso.
- Le istruzioni per l'uso sono una componente dell'apparecchiatura. Devono essere custodite in modo da essere sempre accessibili.
- Se l'apparecchiatura viene installata in un altro luogo, questa deve venire accompagnata dalle istruzioni per l'uso.

## 2 Significato dei simboli



Simbolo sull'apparecchio:

Attenzione, punto pericoloso generico.

Prima di utilizzare l'apparecchiatura leggere in ogni caso le istruzioni per l'uso ed osservare le istruzioni rilevanti per la sicurezza!



Simbolo in questo documento.

Attenzione, punto pericoloso generico.

Questo simbolo contraddistingue le avvertenze relative alla sicurezza e indica situazioni potenzialmente pericolose .

La mancata osservanza di tali avvertenze può causare danni materiali e personali.



Simbolo sull'apparecchiatura ed in questo documento:

Attenzione: rischio biologico.



Simbolo in questo documento:

Questo simbolo indica argomenti importanti.



Simbolo sull'apparecchiatura:

Il simbolo si trova sull'alloggiamento, nelle vicinanze della cerniera.

Senso di rotazione del rotore.



Simbolo sull'apparecchiatura:

Il simbolo si trova davanti sull'alloggiamento, al di sotto del foro.

Senso di rotazione della chiave a brugola esagonale per lo sbloccaggio di emergenza del coperchio.



Simbolo sull'apparecchiatura ed in questo documento:

Simbolo per la raccolta separata delle apparecchiature elettriche ed elettroniche, in conformità alle direttive 2002/96/CEE (WEEE). L'apparecchiatura appartiene al gruppo 8 (apparecchiature medicali).

Impiego nelle nazioni dell'Unione Europea, in Norvegia ed in Svizzera.

### 3 Conformità di impiego

Per quanto riguarda l'apparecchio in oggetto, si tratta di un prodotto medico (centrifuga di laboratorio) ai sensi della direttiva Diagnostici in vitro (IVD) 98/79/CE.

La centrifuga è stata concepita per separare sostanze o miscele di sostanze che hanno una densità massima di 1,2 kg/dm<sup>3</sup>, in particolare di campioni per le preparazioni a scopi diagnostici In-vitro nella medicina umana.

Sotto questa voce ricade in modo speciale l'analisi del potassio nel siero del sangue. La metodologia esecutiva consente una rispettosa separazione ed impedisce un accumulo di ulteriore potassio eritrocitario nel siero. In questo modo si previene una adulterazione dei risultati di analisi.

Le centrifuga è destinata solo a questo scopo d'impiego.

Un diverso od ulteriore tipo di impiego non è regolamentare. La ditta Andreas Hettich GmbH & Co. KG non si prende carico di alcuna responsabilità nel caso di danni da ciò derivanti.

Per l'impiego a norma è previsto anche il rispetto di tutte le avvertenze riportate nelle istruzioni d'uso ed il rispetto degli interventi di ispezione e di manutenzione.

Se la centrifuga viene installata in un'altra apparecchiatura od integrata in un sistema, allora il costruttore del sistema complessivo è responsabile della sicurezza del sistema.

### 4 Rischi residui

L'apparecchio è costruito secondo lo stato attuale della tecnica e le regole riconosciute riguardanti la tecnica della sicurezza. In caso di uso ed impiego non regolamentari possono insorgere pericoli mortali per l'utilizzatore o per terzi risp. danni all'apparecchio o ad altri beni materiali. L'apparecchio è destinato solo all'uso regolamentare e va utilizzato solo in uno stato perfetto per quanto riguarda la tecnica della sicurezza.

Eventuali anomalie, che possono pregiudicare la sicurezza devono essere immediatamente eliminate.

## 5 Dati tecnici

Costruttore	Andreas Hettich GmbH & Co. KG D-78532 Tuttlingen			
Modello	EBA 280		EBA 280 S	
Tipo	1101	1101-01	1102	1102-01
Tensione di rete ( $\pm 10\%$ )	200 - 240 V 1~	100 - 127 V 1~	200 - 240 V 1~	100 - 127 V 1~
Frequenza di rete	50 - 60 Hz	50 - 60 Hz	50 - 60 Hz	50 - 60 Hz
Potenza assorbita	185 VA	185 VA	330 VA	330 VA
Assorbimento di corrente	0.85 A	1.75 A	1.6 A	3.0 A
Capacità max.	6 x 50 ml			
Densità permessa	1.2 kg/dm <sup>3</sup>			
Regime di rotazione (RPM)	6000			
Accelerazione (RCF)	4146		5031	
Energia cinetica	2700 Nm			
Obbligo di collaudo (BGR 500)	no			
Presupposti ambientali (EN / IEC 61010-1)	<p>solo in interni fino a 2000 metri sopra il livello del mare 2°C fino a 40°C umidità relativa massima dell'aria 80% per temperature fino a 31°C, con riduzione lineare fino al 50% dell'umidità relativa per una temperatura di 40°C.</p>			
– luogo di installazione				
– altezza				
– temperatura ambiente				
– umidità dell'aria				
– Categoria di sovratensione (IEC 60364-4-443)	II			
– grado di imbrattamento	2			
Classe di protezione	I			
non adatto per l'impiego in ambiente a rischio di esplosione.				
Compatibilità elettromagnetica	EN / IEC 61326-1, classe B		EN / IEC 61326-1, classe B	
– emissione di radiointerferenze	FCC Class B		FCC Class B	
– resistenza alle interferenze				
Livello di emissione acustica (in funzione del rotore)	$\leq 51$ dB(A)		$\leq 56$ dB(A)	
dimensioni				
– larghezza	326 mm			
– profondità	389 mm			
– altezza	242 mm			
Peso	ca. 11 kg			

## 6 Indicazioni inerenti la sicurezza



**Se non vengono rispettate tutte le avvertenze riportate in queste istruzioni per il funzionamento, non può essere accettata da parte del costruttore alcuna richiesta di garanzia.**



- **La centrifuga deve venire posizionata in modo sicuro.**
- **Prima di utilizzare la centrifuga verificare assolutamente, che il rotore sia innestato sull'albero motore.**
- **Durante un'operazione di centrifugazione, in una zona di sicurezza di 300 mm attorno alla centrifuga non deve sostare alcuna persona, materiali pericolosi ed oggetti, in conformità alle norme EN / IEC 61010-2-020.**
- **I rotor, le sospensioni e gli accessori che presentano forti segni di corrosione o danni meccanici, oppure la cui durata d'impiego è scaduta, non devono più essere utilizzati.**
- **Se il vano di centrifugazione presenta danni rilevanti per la sicurezza, la centrifuga non deve essere più messa in funzione.**
- **Nel caso di centrifughe senza regolazione termica, con temperature ambiente elevate e/o con frequente impiego dell'apparecchiatura può presentarsi un riscaldamento del vano di centrifugazione. Per questo motivo non può venire esclusa una modificazione del materiale di prova a causa alla temperatura.**

- **Prima di mettere in funzione la centrifuga si devono leggere ed osservare le istruzioni per l'uso. L'apparecchio può essere utilizzato solo da persone che abbiano letto e compreso le istruzioni d'uso.**
- Oltre alle istruzioni per l'uso, si devono osservare anche i regolamenti, relativi alla protezione antinfortunistica ed i regolamenti tecnici, riconosciuti in materia di sicurezza del lavoro. Le istruzioni per l'uso vanno completate dalle norme nazionali in vigore nel paese d'impiego, relative alla protezione antinfortunistica ed alla tutela ambientale.
- La centrifuga è costruita in base all'attuale livello tecnologico e le regole di sicurezza conosciute. La centrifuga può essere tuttavia fonte di pericolo per l'operatore o per terzi, se non viene utilizzata da personale appositamente addestrato o se viene utilizzata in modo improprio o non conforme alla destinazione.
- Durante l'esercizio bisogna evitare di muovere la centrifuga o di urtarvi contro.
- In caso di guasto, ovvero del ripristino d'emergenza, non si deve assolutamente toccare il rotore.
- Quando la centrifuga passa da un ambiente freddo in uno caldo, per evitare danni dovuti alla condensa, lasciar riscaldare la centrifuga per almeno 3 ore nell'ambiente caldo prima di collegarla alla rete, oppure portare la centrifuga a temperatura d'esercizio mettendola in funzione per 30 minuti nell'ambiente freddo.
- Devono essere utilizzati esclusivamente i rotor e gli accessori omologati per questa apparecchiatura (vedere capitolo "Anhang/Appendix, Rotoren und Zubehör/Rotors and accessories"). Prima di utilizzare contenitori di centrifugazione, che non sono elencati nel capitolo "Appendice/Appendix, Rotori ed accessori/Rotors and accessories", l'utente deve accertarsi presso il costruttore, che questi possano venire utilizzati.
- Il rotore della centrifuga può essere caricato solo in conformità al capitolo "Carico del rotore".
- In caso di centrifugazione con massimo numero di giri, la densità dei materiali o delle miscele di materiali non deve superare il valore di composizione di  $1,2 \text{ kg/dm}^3$ .
- Non è consentito l'uso di centrifughe non bilanciate in modo regolamentare.
- Non è permesso l'impiego della centrifuga in ambiente a pericolo di esplosione.
- E' proibito l'uso di una centrifuga con:
  - materiali infiammabili od esplosivi
  - materiali che possono reagire chimicamente tra loro con forte energia.
- Se vengono centrifugate sostanze pericolose o miscele di sostanze contaminate da micro organismi tossici, radioattivi o patogeni, l'utente dovrà prendere opportuni provvedimenti in materia. Si devono fundamentalmente utilizzare contenitori per centrifugazione con tappi a vite speciali per sostanze pericolose. Con materiali dei gruppi di rischio 3 e 4, oltre ai contenitori per centrifugazione chiudibili si deve impiegare un sistema di sicurezza biologico (vedi manuale "Laboratory Biosafety Manual" dell'Organizzazione mondiale per la salute). Per questa centrifuga non sono disponibili sistemi di sicurezza biologici.

- Non è consentito il funzionamento della centrifuga con sostanze altamente corrosive che possono pregiudicare la resistenza meccanica dei rotori, delle sospensioni e degli accessori.
- Gli interventi di riparazione devono essere effettuati esclusivamente da una persona autorizzata dal costruttore.
- Devono essere impiegati solo ed esclusivamente pezzi di ricambio originali ed accessori autorizzati della ditta Andreas Hettich GmbH & Co. KG.
- Sono di validità le seguenti norme di sicurezza:  
EN / IEC 61010-1 e EN / IEC 61010-2-020 come anche le loro nazionali varianti.
- La sicurezza e l'affidabilità della centrifuga sono garantite solo se:
  - la centrifuga funziona in conformità con le istruzioni per l'uso
  - l'installazione elettrica sul luogo di posizionamento della centrifuga risponde ai requisiti previsti dalla EN / IEC
  - i collaudi che riguardano la sicurezza dell'apparecchiatura e che sono prescritti nei diversi Stati, p.es. in Germania conformemente alle norme BGV A1 e BGR 500, vengono eseguiti da parte di un perito.

## 7 Trasporto ed immagazzinaggio

### 7.1 Trasporto



Prima di effettuare il trasporto dell'apparecchiatura deve venire installato il dispositivo di sicurezza per il trasporto.

Per il trasporto dell'apparecchiatura e degli accessori devono venire rispettati i seguenti presupposti di ambiente.

- Temperatura ambiente: -20°C fino a +60°C
- Umidità relativa dell'aria: 20% fino a 80%, non condensante

### 7.2 Immagazzinaggio



L'immagazzinaggio dell'apparecchiatura e degli accessori è ammesso solo in ambienti chiusi ed asciutti.

Per l'immagazzinaggio dell'apparecchiatura e degli accessori devono essere rispettati i seguenti presupposti di ambiente.

- Temperatura ambiente: -20°C fino a +60°C
- Umidità relativa dell'aria: 20% fino a 80%, non condensante

## 8 Entità di fornitura

Con la centrifuga vengono forniti i seguenti accessori:

- 1 cavo di allacciamento
- 2 fusibili
- 1 chiave a brugola esagonale
- 1 Istruzioni per l'uso
- 1 foglio delle istruzioni per il dispositivo di sicurezza per il trasporto
- 1 foglio delle istruzioni per lo sbloccaggio di emergenza

Rotore/i e i corrispondenti accessori vengono forniti in base alla commessa.

## 9 Rimuovere il dispositivo di sicurezza per il trasporto



Il dispositivo di sicurezza per il trasporto deve venire assolutamente rimosso.

Conservare il dispositivo di sicurezza per il trasporto, poiché prima di un ulteriore trasporto deve venire reinstallato.

Il trasporto dell'apparecchiatura è ammesso solo con dispositivo di sicurezza per il trasporto installato.

Per proteggere l'apparecchiatura durante il trasporto, il motore viene fissato. Questo dispositivo di sicurezza per il trasporto deve venire rimosso al momento della messa in esercizio dell'apparecchiatura.

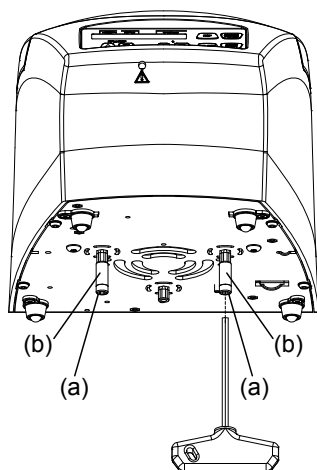

- Rimuovere entrambe le viti (a) e le bussole distanziali (b).



L'installazione del dispositivo di sicurezza per il trasporto avviene nella sequenza inversa.

## 10 Messa in funzione

- Rimuovere il dispositivo di sicurezza per il trasporto che si trova sul fondo dell'alloggiamento, vedere al capitolo "Rimozione del dispositivo di sicurezza".
- **Porre la centrifuga in un posto adatto e livellarla. Per l'installazione deve essere rispettata la zona di sicurezza di 300 mm attorno alla centrifuga, richiesta in conformità alle norme EN / IEC 61010-2-020**



**Durante un'operazione di centrifugazione, in una zona di sicurezza di 300 mm attorno alla centrifuga non deve sostare alcuna persona, materiali pericolosi ed oggetti, in conformità alle norme EN / IEC 61010-2-020.**

- Non posizionare alcun oggetto in prossimità delle griglie di ventilazione. Mantenere un'area di ventilazione di 300 mm, intorno al condotto.
- Verificare se la tensione di rete sia adatta all'indicazione riportata nella targhetta con i dati caratteristici.
- Collegare la centrifuga ad una spina standard di rete tramite il cavo di collegamento. Per la potenza massima assorbita, vedere il capitolo "Dati tecnici".
- Inserire l'interruttore di rete (posizione di interruttore "1"). I LED si illuminano per breve tempo. Sul display compare in successione quanto segue:
  1. il modello di centrifuga
  2. il numero del tipo e la versione di programma
  3. il codice di rotore (R) ed il regime massimo di rotazione del rotore (maxRPM) il rotore riconosciuto da ultimo tramite il contrassegno di rotore
  4. i parametri di centrifugazione del programma utilizzato da ultimo oppure del programma 1



Quando il coperchio è chiuso, viene esposto il messaggio "Open the lid".

In questo caso aprire il coperchio, in modo che i parametri di centrifugazione vengano esposti.



## 11 Aprire e chiudere il coperchio

### 11.1 Aprire il coperchio



Il coperchio si lascia aprire solo, quando la centrifuga è inserita ed il rotore è fermo.  
Se ciò non dovesse essere possibile, vedere al capitolo "Sbloccaggio di emergenza".



Quando il contatore cicli è attivato, dopo ogni operazione di centrifugazione e durante l'apertura del coperchio, viene esposta per breve tempo la quantità residua di cicli operativi (operazioni di centrifugazione).

Esempio:



- Premere il tasto.  
Il coperchio si sblocca motoricamente.  
 : Coperchio sbloccato  
 Il LED di sinistra nel tasto si spegne.

Esempio:



### 11.2 Chiudere il coperchio



Non intervenire con le dita tra il coperchio e l'alloggiamento.  
Non chiudere con violenza il coperchio.

- Adagiare il coperchio e premere leggermente verso il basso il bordo anteriore del coperchio.  
Il coperchio si blocca motoricamente.  
 : Coperchio bloccato.

Il LED di sinistra nel tasto  è luminoso.

Esempio:



## 12 Installazione ed estrazione del rotore

### Rotore con pulsante di sbloccaggio

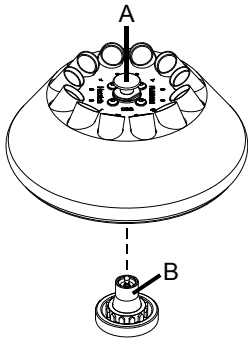

#### Installazione del rotore:

 Le particelle di sporco tra l'albero motore ed il rotore impediscono un perfetto posizionamento in sede del rotore e sono causa di un irrequieto movimento.  
In caso di necessità prima di installare il rotore pulire l'albero motore (B) ed il mozzo del rotore.

- Sollevare il rotore sul pulsante di sbloccaggio (A) ed applicarlo orizzontalmente sull'albero motore (B). Il rotore si innesta automaticamente sull'albero motore.
- Trattenere a destra ed a sinistra il rotore e tirarlo leggermente verso l'alto per controllare, se è innestato esattamente sull'albero motore.

#### Estrazione del rotore:

- Tirare verso l'alto il pulsante di sbloccaggio (A) che si trova sul rotore, trattenerlo e sollevare il rotore dall'albero motore.

### Rotore senza pulsante di sbloccaggio

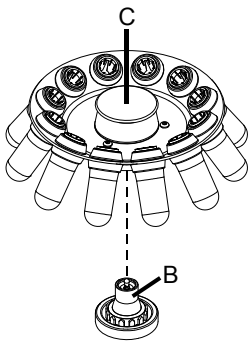

#### Installazione del rotore:

 Le particelle di sporco tra l'albero motore ed il rotore impediscono un perfetto posizionamento in sede del rotore e sono causa di un irrequieto movimento.  
In caso di necessità prima di installare il rotore pulire l'albero motore (B) ed il mozzo del rotore.

- Sollevare il rotore tenendolo sulla maniglia (C), applicarlo in orizzontale sull'albero motore (B) e premere verso il basso fino al fermo di arresto.

#### Estrazione del rotore:

- Trattenere il rotore sulla maniglia (C) e sollevarlo dall'albero motore.

### 13 Carico del rotore



Lo standard dei recipienti di vetro centrifugati sono da caricare fino a RCF 4000 (DIN 58970 capoverso 2).

- Trattenere a destra ed a sinistra il rotore e tirarlo leggermente verso l'alto per controllare, se è innestato esattamente sull'albero motore.
- Nel caso di rotori oscillanti, tutti i siti del rotore devono essere muniti di ganci **uguali**.
- I rotori ed i ganci devono essere caricati esclusivamente in modo simmetrico. I recipienti di centrifuga devono essere distribuiti uniformemente su tutti i posti del rotore. Per le combinazioni permesse vedere capitolo "Anhang/Appendix, Rotoren und Zubehör/Rotors and accessories".  
In caso di rotori angolari devono essere caricati tutti i possibili siti del rotore, vedere il capitolo "Anhang/Appendix, Rotoren und Zubehör/Rotors and accessories".

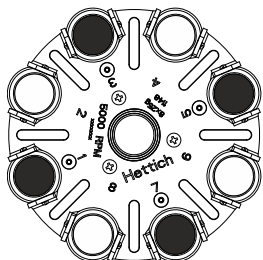

Il rotore è caricato uniformemente

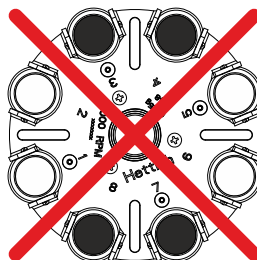

**Non ammesso!**

Il rotore è caricato in modo non uniforme

- Nel caso di contenitori con inserimenti in gomma, deve essere sempre mantenuto lo stesso numero di inserimenti in gomma sotto i contenitori di centrifugazione.
- L'operazione di riempimento dei contenitori di centrifugazione è ammessa solo al di fuori della centrifuga.
- Il carico massimo dei recipienti della centrifuga non deve essere superiore a quello indicato dalla casa costruttrice.

Con rotori a squadra, il riempimento dei contenitori di centrifugazione è consentito solo fino al livello per cui, durante l'operazione di centrifugazione, non venga espulso alcun liquido dai contenitori.

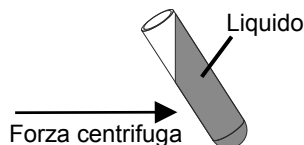

- Con il caricamento di rotori a squadra non deve pervenire alcun liquido nei rotori a squadra e nel vano di centrifugazione.
- Con il caricamento dei ganci dei rotori di smorzamento come anche con lo smorzamento dei ganci durante l'operazione di centrifuga non deve pervenire alcun liquido nei ganci e nel vano di centrifugazione.
- Per limitare al massimo le differenze di peso all'interno dei contenitori di centrifugazione, bisogna fare attenzione che siano riempiti tutti in modo uguale.
- Su ogni rotore è indicato il peso della quantità di riempimento consentita. Tale peso non deve mai essere superato.

## 14 Elementi di comando e di visualizzazione

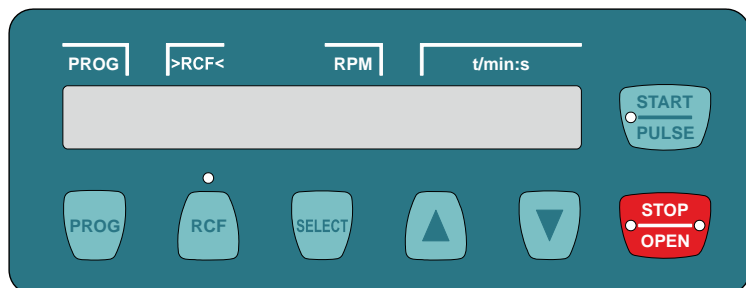

### 14.1 Simboli esposti



Coperchio sbloccato.



Coperchio bloccato.



Indicazione di rotazione. L'indicazione di rotazione si illumina e ruota senso antiorario, per il tempo in cui il rotore è in rotazione.

### 14.2 Tasti del campo di comando



- Richiamare i programmi
- Memorizzare i programmi.



- Commutazione tra l'indicazione RPM (RPM) e l'indicazione RCF (>RCF<). I valori RCF vengono indicati tra parentesi ><. Il LED al di sopra del tasto è luminoso, quando è selezionata l'indicazione RCF.
- RPM: Regime di rotazione  
RCF : Relativa accelerazione centrifugale



- Tasto per la selezione dei singoli parametri. Ad ogni ulteriore pressione del tasto viene selezionato il parametro successivo.
- Richiamare "MACHINE MENU" (tener premuto il tasto per 8 secondi).
- Scegliere nel "Machine Menu" i menu "-> Info", "-> Settings" e "-> Time & Cycles".
- Sfogliare in avanti nei menu.



- Modificare il valore di parametro precedentemente selezionato. Tenendo premuto il tasto il valore cambia con l'incrementare della velocità.



- Avviare il processo di centrifugazione. Il LED nel tasto è luminoso durante il processo di centrifugazione, per il tempo in cui il rotore è in rotazione.
- Centrifugazione breve. Il processo di centrifugazione avviene, per il tempo in cui il tasto viene premuto. Il LED nel tasto è luminoso durante il processo di centrifugazione, per il tempo in cui il rotore è in rotazione.
- Memorizzare gli inoltri e le modifiche.
- Richiamare i menu "-> Info", "-> Settings" e "-> Time & Cycles".



- Terminare il processo di centrifugazione. Il rotore rallenta con il livello di frenata preselezionato. Il LED di destra nel tasto è luminoso fino a quando il rotore è fermo. Una volta che il rotore si è fermato si illumina il LED di sinistra nel tasto. Una doppia pressione del tasto sgancia l'Arresto di Emergenza.
- Sbloccare il coperchio. Il LED di sinistra nel tasto si spegne.

### 14.3 Possibilità di regolazione

**PROG RCL** **Posto di programma del programma da richiamare.**  
Sono richiamabili i posti di programma 1 fino a 9 e #.

**t/min** **Tempo di funzionamento.** Regolabile da 1 - 99 min, in passi di 1 minuto.

**t/sec** **Tempo di funzionamento.** Regolabile da 1 - 59 s, in passi di 1 secondo.

**Funzionamento continuo "--:--".** Impostare il parametro **t/min** e **t/sec** su zero.

**Begins at START** **Conteggio del tempo di processo.**  
Il tempo di processo inizia a conteggiare subito dopo l'avvio del processo di centrifugazione.

**Begins at SPEED** Il tempo di processo inizia a conteggiare solo dopo il raggiungimento del regime di rotazione impostato.



L'impostazione è possibile solo, quando è attiva la funzione "Dual time", vedere al capitolo "Attivare/disattivare funzione "Dual time" ". La funzione è attivata di fabbrica.

**RPM** **Regime di rotazione**  
Può essere impostato un valore numerico di 200 RPM fino al regime massimo di rotazione del rotore. Impostabile ad intervalli di 10.  
Per il regime massimo di rotazione del rotore vedere al capitolo "Appendice/Appendix, Rotori ed accessori/Rotors and accessories".

**RAD/mm** **Raggio di centrifugazione**  
Impostabile da 10 mm fino a 330 mm, in passi di 1 millimetro.  
Per il raggio di centrifugazione vedere al capitolo "Appendice/Appendix, Rotori ed accessori/Rotors and accessories".



L'inoltro del raggio di centrifugazione è possibile solo, se viene scelta l'indicazione RCF (>RCF<).

**RCF** **Accelerazione relativa di centrifuga**  
Può essere impostato un valore numerico, con il quale si ottiene un regime di rotazione tra 200 RPM ed il massimale regime di rotazione del rotore.  
Impostabile ad intervalli di 1.



L'inoltro della accelerazione relativa di centrifuga (RCF) è possibile solo, se viene scelta l'indicazione RCF (>RCF<).

L'accelerazione relativa di centrifuga (RCF) dipende dal raggio di centrifugazione (RAD). Viene esposta la relativa accelerazione centrifugale (RCF) ed il raggio di centrifugazione impostato (RAD).



1 – 9. közötti indulási fokozatok. 9. fokozat = legrövidebb indulási idő, 1. fokozat = leghosszabb indulási idő.



0 – 9. közötti fékezési fokozatok. 9. fokozat = legrövidebb leállási idő, 1. fokozat = hosszú leállási idő, 0. fokozat = leghosszabb leállási idő (fékezés nélküli leállítás).

**PROG STO** **Posto di programma sul quale viene memorizzato il programma.**  
Possono venir memorizzati 9 programmi (posti di programma 1 fino a 9).



Sul posto di programma # non dovrebbe venir memorizzato alcun programma.

Il posto di programma # serve da memoria intermedia, per i parametri centrifugazione che sono stati modificati.

I parametri di centrifugazione sul posto di programma # vengono sovrascritti ogni volta, quando viene eseguito un processo di centrifugazione con parametri di centrifugazione modificati, che non sono stati memorizzati su di un posto di programma.

## 15 Programmazione



Sul posto di programma # non dovrebbe venir memorizzato alcun programma.

Il posto di programma # serve da memoria intermedia, per i parametri centrifugazione che sono stati modificati.

Se i parametri di centrifugazione vengono modificati, ma non vengono poi memorizzati su di un posto di programma, sul display viene esposto un trattino "-" al posto del numero di posto di programmi. Dopo l'avvio del processo di centrifugazione, questi parametri di centrifugazione vengono poi memorizzati automaticamente sul posto di programma #.

I parametri di centrifugazione sul posto di programma # vengono sovrascritti ogni volta, quando viene eseguito un processo di centrifugazione con parametri di centrifugazione modificati, che non sono stati memorizzati su di un posto di programma.

### 15.1 Immettere o modificare i dati



Per impostare il funzionamento continuo, i parametri **t/min** e **t/sec** devono venir impostati su zero. Sull'indicatore del tempo (t/min:s) compare "--:--".

Esempio:



La relativa accelerazione centrifugale (RCF) dipende dal raggio di centrifugazione (RAD). Un esatto calcolo è possibile solo, quando è impostato l'esatto raggio di centrifugazione. Durante l'inoltro di RCF viene esposto il raggio di centrifugazione che è impostato.

Esempio:



L'esposizione e l'inoltro della relativa accelerazione centrifugale (RCF) e del raggio di centrifugazione (RAD) sono possibili solo, quando è selezionata l'indicazione RCF (➤RCF<).

Se dopo la selezione o durante l'inoltro dei parametri, per otto secondi di tempo non viene premuto alcun tasto, sul display vengono esposti di nuovo di valori precedenti. L'inoltro dei parametri deve poi venire eseguito nuovamente.



L'inoltro dei parametri può sempre venire interrotto premendo il tasto . In questo caso le impostazioni non vengono memorizzate.



- Premere il tasto **SELECT**.  
**PROG RCL** : posto di programma del parametro di centrifugazione indicato.



- Impostare con i tasti il posto di programma, i cui parametri di centrifugazione debbono venir esposti.



- Premere il tasto **START PULSE**.  
I parametri di centrifugazione vengono esposti.



Prosegue alla pagina successiva

Esempio:

Indicazione RPM (RPM)



Esempio:

Indicazione RCF (➤RCF<)





- In caso di necessità premere il tasto, per selezionare l'indicazione RPM (RPM) oppure l'indicazione RCF (>RCF<). Il LED al di sopra del tasto si illumina, quando è selezionata l'indicazione RCF (>RCF<).



- Premere più volte il tasto fino a quando appare il parametro di centrifugazione desiderato.  
Esempio: **t/min** : Tempo di funzionamento, minuti



- Impostare con i tasti il valore desiderato.



- Immettere uno dopo l'altro tutti i parametri di centrifugazione desiderati.



- Premere il tasto più volte fino a quando compare la successiva videata.  
**PROG STO** : Posto di programma sul quale vengono memorizzati i parametri di centrifugazione.



- Impostare con i tasti il desiderato posto di programma.



- Premere il tasto .  
I parametri di centrifugazione vengono memorizzati sul posto di programma.

### Esempio: Indicazione RPM (RPM)

PROG	>RCF<	RPM	t/min:s
1	▣	4500	5:00

PROG	>RCF<	RPM	t/min:s
t/min		=05:00	

PROG	>RCF<	RPM	t/min:s
t/min		=04:00	

PROG	>RCF<	RPM	t/min:s
t/sec		=04:30	

PROG	>RCF<	RPM	t/min:s
PROG STO =		1	

PROG	>RCF<	RPM	t/min:s
PROG STO =		3	

PROG	>RCF<	RPM	t/min:s
*** OK ***			

PROG	>RCF<	RPM	t/min:s
3	▣	4500	4:30

### Esempio: Indicazione RCF (>RCF<)

PROG	>RCF<	RPM	t/min:s
1	▣	> 2853 <	5:00

PROG	>RCF<	RPM	t/min:s
t/min		=05:00	

PROG	>RCF<	RPM	t/min:s
t/min		=04:00	

PROG	>RCF<	RPM	t/min:s
t/sec		=04:30	

PROG	>RCF<	RPM	t/min:s
PROG STO =		1	

PROG	>RCF<	RPM	t/min:s
PROG STO =		3	

PROG	>RCF<	RPM	t/min:s
*** OK ***			

PROG	>RCF<	RPM	t/min:s
3	▣	> 2853 <	4:30

## 15.2 Richiamare i programmi



- Premere il tasto .  
**PROG RCL** : Posto di programma del parametro di centrifugazione esposto.



- Impostare con i tasti il posto di programma, i cui parametri di centrifugazione debbono venir esposti.



- Premere il tasto .  
I parametri di centrifugazione vengono esposti.

### Esempio: Indicazione RPM (RPM)



### Esempio: Indicazione RCF (>RCF<)



## 15.3 Memorizzare programmi



- Premere due volte il tasto.  
**PROG STO** : Posto di programma sul quale vengono memorizzati parametri di centrifugazione.



- Impostare con i tasti il posto di programma, sul quale debbono venir memorizzati i parametri di centrifugazione.



- Premere il tasto .  
I parametri di centrifugazione vengono memorizzati sul posto di programma.

### Esempio: Indicazione RPM (RPM)



### Esempio: Indicazione RCF (>RCF<)





## 16 Centrifugazione



Durante un processo di centrifugazione, come da norme EN / IEC 61010-2-020 non deve trovarsi alcuna persona, prodotti pericolosi ed oggetti in un settore di sicurezza di 300 mm attorno alla centrifuga.



Dopo ogni processo di centrifugazione, durante lo sbloccaggio del coperchio, viene esposta per breve tempo la quantità dei cicli operativi rimanenti (processi di centrifugazione).

Esempio:



Se la differenza di peso ammessa all'interno del caricamento del rotore è stata oltrepassata, il processo di centrifugazione viene interrotto durante l'avvio e compare la seguente videata.



Un processo di centrifugazione può sempre venire interrotto premendo il tasto .

Durante un processo di centrifugazione i parametri di centrifugazione possono venire selezionati e modificati. I valori modificati vengono memorizzati sul posto di programma #.

Con il tasto  può avvenire in qualsiasi momento la commutazione tra l'indicazione RPM (RPM) e l'indicazione RCF (>RCF<). Se il lavoro avviene con l'indicazione RCF (>RCF<) è necessario l'inoltro del raggio di centrifugazione.

Viene esposto quanto segue



un ulteriore intervento operativo alla centrifuga è possibile solo dopo l'apertura del coperchio.

Gli errori operativi e le anomalie vengono esposti (vedere il capitolo "Anomalie").

- Inserire l'interruttore di rete. Posizione dell'interruttore I.
- Caricare il rotore e chiudere il coperchio della centrifuga.

### 16.1 Centrifugazione con preselezione del tempo



- In caso di necessità premere il tasto, per selezionare l'indicazione RPM (RPM) oppure l'indicazione RCF (>RCF<). Il LED che si trova al di sopra del tasto si illumina, quando è selezionata l'indicazione RCF (>RCF<).



- Immettere i parametri di centrifugazione desiderati (vedere al capitolo "Programmazione").



- Premere il tasto. Il processo di centrifugazione viene avviato. Durante il processo di centrifugazione vengono esposti il regime di rotazione del rotore od il valore RCF che ne risulta e il tempo residuo.



Prosegue alla pagina successiva

Esempio:  
Indicazione RPM (RPM)



Esempio:  
Indicazione RCF (>RCF<)



- Una volta decorso il tempo o dopo l'interruzione del processo di centrifugazione premendo il tasto , avviene l'arresto con il livello di frenate impostato. Viene esposto il livello di frenata. Esempio  $\sim 7$

#### Esempio: Indicazione RPM (RPM)

PROG	>RCF<	RPM	t/min:s
1	□	3980	$\sim 7$

#### Esempio: Indicazione RCF (>RCF<)

PROG	>RCF<	RPM	t/min:s
1	□	> 2231<	$\sim 7$

## 16.2 Funzionamento continuo



- In caso di necessità premere il tasto, per selezionare l'indicazione RPM (RPM) oppure l'indicazione RCF (>RCF<). Il LED al di sopra del tasto si illumina, quando è selezionata l'indicazione RCF (>RCF<).



- Immettere il parametro di centrifugazione desiderato. Porre il programma  $t/min$  e  $t/sec$  su zero (vedere al capitolo "Programmazione").



- Premere il tasto . Il processo di centrifugazione viene avviato. Durante il processo di centrifugazione vengono esposti il regime di rotazione del rotore od il valore RCF che ne risulta e il tempo decorso.



- Premere il tasto . Processo di centrifugazione viene terminato. L'arresto avviene con il livello di frenata impostato. Viene esposto il livello di frenata. Esempio  $\sim 7$

#### Esempio: Indicazione RPM (RPM)

PROG	>RCF<	RPM	t/min:s
1	□	4500	5:00

#### Esempio: Indicazione RCF (>RCF<)

PROG	>RCF<	RPM	t/min:s
1	□	> 2853<	5:00

PROG	>RCF<	RPM	t/min:s
1	□	4000	--:--

PROG	>RCF<	RPM	t/min:s
1	□	> 2254<	--:--

PROG	>RCF<	RPM	t/min:s
1	□	4000	2:45

PROG	>RCF<	RPM	t/min:s
1	□	> 2254<	2:45

PROG	>RCF<	RPM	t/min:s
1	□	3980	$\sim 7$

PROG	>RCF<	RPM	t/min:s
1	□	> 2231<	$\sim 7$

### 16.3 Centrifugazione breve



- In caso di necessità premere il tasto, per selezionare l'indicazione RPM (RPM) oppure l'indicazione RCF (>RCF<). Il LED al di sopra del tasto si illumina, quando è selezionata l'indicazione RCF (>RCF<).



- Immettere il parametro di centrifugazione desiderato (vedere al capitolo "Programmazione").



- Premere il tasto e tenerlo premuto. Durante il processo di centrifugazione vengono esposti il regime di rotazione del rotore od il valore RCF che ne risulta e il tempo decorso.



- Abbandonare di nuovo il tasto. Il processo di centrifugazione viene terminato. L'arresto avviene con il livello di frenata impostato. Viene esposto il livello di frenata. Esempio  $\sim$ \_7.

#### Esempio: Indicazione RPM (RPM)

PROG	>RCF<	RPM	t/min:s
1		4500	5:00

#### Esempio: Indicazione RCF (>RCF<)

PROG	>RCF<	RPM	t/min:s
1	>	2853<	5:00

PROG	>RCF<	RPM	t/min:s
1		4000	5:00

PROG	>RCF<	RPM	t/min:s
1	>	2254<	5:00

PROG	>RCF<	RPM	t/min:s
1		4000	0:24

PROG	>RCF<	RPM	t/min:s
1	>	2254<	0:24

PROG	>RCF<	RPM	t/min:s
1		3980	$\sim$ _7

PROG	>RCF<	RPM	t/min:s
1	>	2231<	$\sim$ _7

### 17 Arresto di Emergenza



- Premere due volte il tasto. Con l'arresto di emergenza, l'arresto avviene con il livello di frenata 9 (arresto nel tempo più breve). Viene esposto il livello di frenata  $\sim$ \_9.

#### Esempio: Indicazione RPM (RPM)

PROG	>RCF<	RPM	t/min:s
1		4270	$\sim$ _9

#### Esempio: Indicazione RCF (>RCF<)

PROG	>RCF<	RPM	t/min:s
1	>	2568<	$\sim$ _9

## 18 Riconoscimento rotore

La centrifuga è dotata di un riconoscimento automatico del rotore.

Dopo l'avvio di ciascun processo di centrifugazione viene eseguito un riconoscimento del rotore.

Quando il sistema di riconoscimento del rotore legge per la prima volta il codice di un rotore, il processo di centrifugazione si ferma automaticamente dopo il riconoscimento del rotore. Vengono esposti il codice del rotore (R) ed il regime di rotazione massimo (maxRPM) del rotore che sono ammessi per questa centrifuga.

Esempio:



Dopo l'arresto del rotore (il LED di sinistra nel tasto  si illumina) deve venir premuto un tasto a piacimento. In seguito viene esposta la quantità massima ammessa dei cicli operativi.

Esempio:



Ora deve venire impostata la quantità massima ammessa di cicli operativi del rotore risp. dei ganci (vedere al capitolo "Contatore cicli").

Con l'impiego di un rotore, il cui codice di rotore è stato già letto una volta dal sistema di riconoscimento rotore, dopo l'avvio del processo di centrifugazione viene esposto brevemente il regime di rotazione massimo (ROTOR MAX) del rotore, che è ammesso per questa centrifuga.

Esempio:



Se il regime di rotazione impostato è maggiore di quello ammesso per la centrifuga, massimo regime di rotazione del rotore, il processo di centrifugazione viene interrotto dopo il riconoscimento del rotore e compaiono in alternanza le seguenti videate:

Esempio:



In questo caso il regime di rotazione indicato deve venir controllato e deve venir adeguato al regime massimo di rotazione del rotore.

## 19 Contatore cicli



La durata di impiego di particolari rotori e ganci è limitata ad una quantità massima di cicli operativi ( processi di centrifugazione). I rotori ed i ganci interessati sono contrassegnati con la quantità massima ammessa di cicli operativi.

La centrifuga è dotata di un contatore cicli, che conteggia i cicli operativi (processi di centrifugazione) dei diversi codici di rotore (vedere anche al capitolo "Riconoscimento rotore").

Dopo ogni processo di centrifugazione , durante lo sbloccaggio del coperchio, viene esposta per breve tempo la quantità dei cicli operativi rimanenti (processi di centrifugazione).

Esempio:



Se la quantità massima ammessa dei cicli operativi è oltrepassata, dopo ogni avvio di un processo di centrifugazione compare la seguente videata ed il processo di centrifugazione deve essere avviato di nuovo.



Compare l'indicazione



per ragioni di sicurezza il rotore interessato, risp. i ganci interessati devono venire sostituiti immediatamente con un nuovo rotore risp. con dei nuovi ganci.

Una volta che il rotore risp. i ganci sono stati sostituiti, il contatore dei cicli del rispettivo codice di rotore deve venir di nuovo resettato sul valore zero (vedere al capitolo "Resettare su zero il contatore cicli").

Quando il sistema di riconoscimento del rotore legge per la prima volta il codice di un rotore, il processo di centrifugazione si ferma automaticamente dopo il riconoscimento del rotore. Vengono esposti il codice del rotore (R) ed il regime di rotazione massimo (maxRPM) del rotore che sono ammessi per questa centrifuga. Infine deve venire impostata la quantità massima ammessa dei cicli operativi del rotore risp. dei ganci.



Per rotori di smorzamento deve venire impostata sempre la quantità massima ammessa dei cicli operativi dei ganci.

La quantità massima ammessa dei cicli operativi del rotore risp. dei ganci deve venir impostata come segue:

**Esempio:**

Indicazione dopo il riconoscimento rotore.

**R** : Codice rotore del rotore.

**maxRPM** : Il massimo regime di rotazione rotore, che è ammesso per questa centrifuga.



Premere un tasto a piacimento.

- Attendere fino a quando il LED di sinistra nel tasto  si illumina.

- Premere un tasto a piacimento. Viene esposta la quantità massima ammessa dei cicli operativi.



Prosegua alla pagina successiva

**Esempio:**

- Verificare, se la quantità massima ammessa indicata dei cicli operativi corrisponde con i dati riportati per il rotore risp. per i ganci

In caso contrario, devono venire impostati la quantità massima ammessa dei cicli operativi dichiarati per il rotore risp. per i ganci.

- ☞ Per rotori e ganci, la cui durata di impiego non è limitata ad una quantità massima di cicli operativi (processi di centrifugazione), deve venire impostato il valore zero.



- Impostare con i tasti il valore esatto.

PROG	>RCF<	RPM	t/min:s
Cyc lim=< 50000>			



- Premere il tasto .  
La quantità massima ammessa dei cicli operativi viene memorizzata.

PROG	>RCF<	RPM	t/min:s
1	■	4500	5:00

## 20 Impostazioni e consultazioni

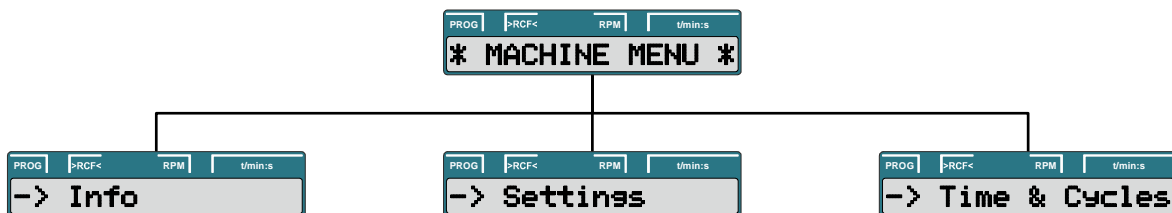

### Consultazione:

- Informazioni di sistema (capitolo 20.1)

### Impostazione:

- Segnale acustico (capitolo 20.2)
- Sbloccaggio automatico del coperchio dopo il processo di centrifugazione (capitolo 20.4)
- Disinserimento automatico della illuminazione di sfondo (capitolo 20.5)
- Segnale ottico dopo la conclusione del processo di centrifugazione (capitolo 20.3)
- Parametro di centrifugazione indicato dopo l'inserimento dell'apparecchiatura (capitolo 20.6)
- Attivare/ disattivare la funzione "Dual time" (capitolo 20.7)

### Consultazione:

- Ore di funzionamento (capitolo 20.8)
- Quantità di processi di centrifugazione eseguiti (capitolo 20.8)

### Impostazione:



- Contatore cicli (capitolo 20.9)



















## 20.1 Consultare informazioni di sistema

Possono venir consultate le seguenti informazioni di sistema:

- Modello di centrifuga,
- I regimi di rotazione massimi dei differenti codici di rotore,
- Versione di programma della centrifuga,
- Tipo di convertitore di frequenza,
- Versione di programma del convertitore di frequenza

La consultazione può essere eseguita, durante l'arresto del rotore, come segue:

 Il processo può sempre venire interrotto premendo il tasto .

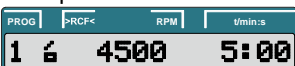
	• Tenere premuto il tasto 8 secondi.		
↓			
	• Premere il tasto .		
↓			
	• Premere il tasto . Modello di centrifuga		
↓			
	• Premere il tasto . <b>R</b> : Codice rotore del rotore. <b>*</b> : Il codice di rotore del rotore utilizzato attualmente è contrassegnato con un asterisco (*). <b>RPMmax</b> : Il massimo regime di rotazione rotore, che è ammesso per questa centrifuga.	Esempio: 	
↓			
	• Con i tasti possono venir esposti i regimi di rotazione massimi dei diversi codici di rotore.	Esempio: 	
↓			
	• Premere il tasto . Versione di programma della centrifuga.	Esempio: 	
↓			
	• Premere il tasto . Tipo di convertitore di frequenza.	Esempio: 	
↓			
	• Premere il tasto . Versione di programma del convertitore di frequenza.	Esempio: 	
↓			
	• Premere due volte il tasto, per abbandonare il menu "-> Info" o premere tre volte, per abbandonare il menu "* MACHINE MENU *".	Esempio: 	





## 20.2 Segnale acustico

























Suona il segnale acustico:

- dopo che si è presentata un'anomalia, in intervalli di 2 s.
- dopo che è terminato il processo di centrifugazione e con l'arresto del rotore, in intervalli di 30 s.

Il segnale acustico viene disinserito premendo un tasto a piacimento.

Il segnale acustico può essere impostato, durante l'arresto del rotore, come segue:

 Il processo può sempre venire interrotto premendo il tasto . In questo caso le impostazioni non vengono memorizzate.

	• Tenere premuto il tasto 8 secondi.		
↓			
	• Premere il tasto più volte fino a quando compare la successiva videata.		
↓			
	• Premere il tasto . <b>End beep</b> : Segnale acustico dopo che il processo di centrifugazione è terminato. <b>off</b> : Segnale disattivato. <b>on</b> : Segnale attivato.		
↓			
	• Impostare con i tasti <b>off</b> (disinserito) oppure <b>on</b> (inserito).		
↓			
	• Premere il tasto . <b>Error beep</b> : Segnale acustico dopo che si è presentata un'anomalia. <b>off</b> : Segnale disattivato. <b>on</b> : Segnale attivato.		
↓			
	• Impostare con i tasti <b>off</b> (disinserito) oppure <b>on</b> (inserito).		
↓			
	• Premere il tasto . <b>Beep volume</b> : Intensità del segnale acustico. <b>min</b> : lieve <b>mid</b> : media <b>max</b> : forte		
↓			
↓			
	• Impostare con i tasti <b>min</b> , <b>mid</b> , oppure <b>max</b> .		
↓			

Prosegue alla pagina successiva



- Premere il tasto per memorizzare l'impostazione.

PROG | >RCF< | RPM | U/min:s  
Store settings...

PROG | >RCF< | RPM | U/min:s  
-> Settings



- Premere una volta il tasto, per abbandonare il menu  
"-> Settings" oppure prendere due volte, per abbandonare il menu "\* MACHINE MENU \*".

PROG | >RCF< | RPM | U/min:s  
\* MACHINE MENU \*

Esempio:

PROG | >RCF< | RPM | U/min:s  
1 6 4500 5:00

### 20.3 Segnale ottico dopo la fine del processo di centrifugazione

La illuminazione di sfondo della videata lampeggia dopo il processo di centrifugazione, per segnalare otticamente che il processo di centrifugazione è terminato.

Il segnale ottico può essere inserito o disinserito, durante l'arresto del rotore, come segue:



Il processo può sempre venire interrotto premendo il tasto



- Tenere premuto il tasto 8 secondi.

PROG | >RCF< | RPM | U/min:s  
\* MACHINE MENU \*



- Premere il tasto più volte fino a quando compare la successiva videata.

PROG | >RCF< | RPM | U/min:s  
-> Settings



- Premere il tasto .

PROG | >RCF< | RPM | U/min:s  
End beep =off

PROG | >RCF< | RPM | U/min:s  
End beep =on



- Premere più volte il tasto fino a quando compare una delle due videate.  
**End blinking** : Lampeggio della illuminazione di sfondo della videata dopo il processo di centrifugazione.  
**off** : La illuminazione di sfondo non lampeggia.  
**on** : La illuminazione di sfondo lampeggia.

PROG | >RCF< | RPM | U/min:s  
End blinking=off

PROG | >RCF< | RPM | U/min:s  
End blinking=on



- Impostare con i tasti **off** (disinserito) oppure **on** (inserito).

PROG | >RCF< | RPM | U/min:s  
End blinking=off

PROG | >RCF< | RPM | U/min:s  
End blinking=on



- Premere il tasto per memorizzare l'impostazione.

PROG | >RCF< | RPM | U/min:s  
Store settings...

PROG | >RCF< | RPM | U/min:s  
-> Settings



- Premere una volta il tasto, per abbandonare il menu  
"-> Settings" oppure prendere due volte, per abbandonare il menu "\* MACHINE MENU \*".

PROG | >RCF< | RPM | U/min:s  
\* MACHINE MENU \*

Esempio:

PROG | >RCF< | RPM | U/min:s  
1 6 4500 5:00

## 20.4 Sbloccaggio automatico del coperchio dopo il processo di centrifugazione

Può avvenire l'impostazione, se dopo il processo di centrifugazione il coperchio si sblocca o meno.

Ciò può venire impostato, durante l'arresto del rotore, come segue:



Il processo può sempre venire interrotto premendo il tasto . In questo caso le impostazioni non vengono memorizzate.



- Tenere premuto il tasto 8 secondi.



- Premere il tasto più volte fino a quando compare la successiva videata.



- Premere il tasto .



- Premere più volte il tasto fino a quando compare una delle due videate.  
**Lid AutoOpen** : Sbloccaggio automatico del coperchio dopo il processo di centrifugazione.  
**off** : Il coperchio non si sblocca automaticamente.  
**on** : Il coperchio si sblocca automaticamente.



- Impostare con i tasti **off** oppure **on** .



- Premere il tasto per memorizzare l'impostazione.



- Premere una volta il tasto, per abbandonare il menu "-> Settings" oppure prendere due volte, per abbandonare il menu "\* MACHINE MENU \*" .





Esempio:





















## 20.5 Illuminazione di sfondo della videata

Per risparmiare energia può venire impostato, che dopo un processo di centrifugazione l'illuminazione di sfondo della videata si spenga dopo due minuti.

Ciò può venire impostato, durante l'arresto del rotore, come segue:



 Il processo può sempre venire interrotto premendo il tasto . In questo caso le impostazioni non vengono memorizzate.

















	<ul style="list-style-type: none"> <li>• Tenere premuto il tasto 8 secondi.</li> </ul>		
↓			
	<ul style="list-style-type: none"> <li>• Premere il tasto più volte fino a quando compare la successiva videata.</li> </ul>		
↓			
	<ul style="list-style-type: none"> <li>• Premere il tasto .</li> </ul>		
↓			
	<ul style="list-style-type: none"> <li>• Premere più volte il tasto fino a quando compare una delle due videate.  <b>Power save</b> : Disinserimento automatico dell'illuminazione di sfondo.  <b>off</b> : Disinserimento automatico disattivato.  <b>on</b> : Disinserimento automatico attivato.</li> </ul>		
↓			
	<ul style="list-style-type: none"> <li>• Impostare con i tasti <b>off</b> (disinserito) oppure <b>on</b> (inserito).</li> </ul>		
↓			
	<ul style="list-style-type: none"> <li>• Premere il tasto per memorizzare l'impostazione.</li> </ul>		
↓			
↓			
	<ul style="list-style-type: none"> <li>• Premere una volta il tasto, per abbandonare il menu "-&gt; Settings" oppure prendere due volte, per abbandonare il menu "* MACHINE MENU *" .</li> </ul>		<p>Esempio:</p> 

## 20.6 Parametro di centrifugazione indicato dopo l'inserimento dell'apparecchiatura

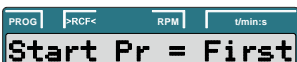
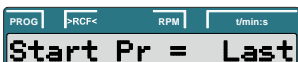
Può avvenire la scelta di impostazione, se dopo l'inserimento dell'apparecchiatura devono venire esposti i parametri di centrifugazione del programma utilizzato da ultimo oppure del programma 1.

Ciò può venire impostato, durante l'arresto del rotore, come segue:



 Il processo può sempre venire interrotto premendo il tasto . In questo caso le impostazioni non vengono memorizzate.



















	• Tenere premuto il tasto 8 secondi.		
↓			
	• Premere il tasto più volte fino a quando compare la successiva videata.		
↓			
	• Premere il tasto .		
↓			
	• Premere più volte il tasto fino a quando compare una delle due videate. <b>Start Pr</b> : programma indicato dopo l'inserimento. <b>First</b> : programma 1. <b>Last</b> : programma utilizzato da ultimo.		
↓			
	• Con i tasti impostare <b>First</b> oppure <b>Last</b> .		
↓			
	• Premere il tasto per memorizzare l'impostazione.		
↓			
↓			
	• Premere una volta il tasto, per abbandonare il menu "→ Settings" oppure prendere due volte, per abbandonare il menu "* MACHINE MENU *".		Esempio: 

## 20.7 Attivare/ disattivare funzione "Dual time"

Per poter impostare il conteggio del tempo di funzionamento (parametro **Begins at START** e parametro **Begins at SPEED**), deve essere attivata la funzione "Dual time". La funzione è attivata di fabbrica.

Ciò può venire impostato, durante l'arresto del rotore, come segue:

 Il processo può sempre venire interrotto premendo il tasto . In questo caso le impostazioni non vengono memorizzate.

	<ul style="list-style-type: none"> <li>• Tenere premuto il tasto 8 secondi.</li> </ul>		
↓			
	<ul style="list-style-type: none"> <li>• Premere il tasto più volte fino a quando compare la successiva videata.</li> </ul>		
↓			
	<ul style="list-style-type: none"> <li>• Premere il tasto .</li> </ul>		
↓			
	<ul style="list-style-type: none"> <li>• Premere più volte il tasto fino a quando compare una delle due videate.  <b>Dual time</b> : Conteggio del tempo di processo.  <b>on</b> : Funzione è attivata.  <b>off</b> : Funzione è disattivata.</li> </ul>		
↓			
	<ul style="list-style-type: none"> <li>• Impostare con i tasti <b>off</b> (disinserito) oppure <b>on</b> (inserito).</li> </ul>		
↓			
	<ul style="list-style-type: none"> <li>• Premere il tasto per memorizzare l'impostazione.</li> </ul>		
↓			
	<ul style="list-style-type: none"> <li>• Premere una volta il tasto, per abbandonare il menu "-&gt; Settings" oppure prendere due volte, per abbandonare il menu "* MACHINE MENU *" .</li> </ul>		<p>Esempio:</p> 



## 20.8 Consultazione delle ore di funzionamento e della quantità di processi di centrifugazione

Le ore di funzionamento sono suddivise in ore di funzionamento interne ed esterne.

Ore di funzionamento interne: Tempo complessivo, nel quale l'apparecchiatura era inserita.

Ore di funzionamento esterne: Tempo complessivo dei processi di centrifugazione avvenuti fino ad ora.

La consultazione può essere eseguita, durante l'arresto del rotore, come segue:

 Il processo può sempre venire interrotto premendo il tasto .



- Tenere premuto il tasto 8 secondi.

PROG | PRCF< | RPM | t/min:s  
\* MACHINE MENU \*



- Premere il tasto più volte fino a quando compare la successiva videata.

PROG | PRCF< | RPM | t/min:s  
-> Time & Cycles



- Premere il tasto .  
**TimeExt** : Ore di funzionamento esterne.

Esempio:

PROG | PRCF< | RPM | t/min:s  
TimeExt= 1543 h



- Premere il tasto .  
**TimeInt** : Ore di funzionamento interne.

Esempio:

PROG | PRCF< | RPM | t/min:s  
TimeInt= 1760 h



- Premere il tasto .  
**Starts** : Quantità di tutti i processi di centrifugazione.

Esempio:

PROG | PRCF< | RPM | t/min:s  
Starts = 8325



- Premere due volte il tasto, per abbandonare il menu "-> Time & Cycles" o premere tre volte, per abbandonare il menu "\* MACHINE MENU \*".

PROG | PRCF< | RPM | t/min:s  
\* MACHINE MENU \*

Esempio:



PROG | PRCF< | RPM | t/min:s  
1 4 4500 5:00

## 20.9 Resettare su zero il contatore cicli

Una volta che il rotore risp. i ganci sono stati sostituiti, il contatore dei cicli del rispettivo codice di rotore deve venir di nuovo resettato sul valore zero.

 Il resettaggio del contatore dei cicli sul valore zero è ammesso, quando in precedenza il rotore risp. i ganci sono stati sostituiti con un nuovo rotore risp. con nuovi ganci.

Il resettaggio del contatore cicli può essere eseguito, durante l'arresto del rotore, come segue:

 Il processo può sempre venire interrotto premendo il tasto . In questo caso le impostazioni non vengono memorizzate.



- Tenere premuto il tasto 8 secondi.

PROG | >RCF< | RPM | U/min:s  
\* MACHINE MENU \*



- Premere il tasto più volte fino a quando compare la successiva videata.

PROG | >RCF< | RPM | U/min:s  
-> Time & Cycles



- Premere il tasto .

Esempio:

PROG | >RCF< | RPM | U/min:s  
TimeExt= 1543 h



- Premere il tasto più volte fino a quando compare la successiva videata.  
**Cyc sum** : Quantità di cicli operativi eseguiti.

PROG | >RCF< | RPM | U/min:s  
Cyc sum= 50001



- Premere il tasto .

PROG | >RCF< | RPM | U/min:s  
Cyc sum=< 50001>



- Premere il tasto .  
La quantità di cicli operativi eseguiti viene resettata su zero.

PROG | >RCF< | RPM | U/min:s  
Cyc sum=< 0>



- Premere il tasto per memorizzare l'impostazione.

PROG | >RCF< | RPM | U/min:s  
Store cycles ...

PROG | >RCF< | RPM | U/min:s  
Cyc sum= 0



- Premere due volte il tasto, per abbandonare il menu "-> Time & Cycles" o premere tre volte, per abbandonare il menu "\* MACHINE MENU \*".

PROG | >RCF< | RPM | U/min:s  
\* MACHINE MENU \*

Esempio:

PROG | >RCF< | RPM | U/min:s  
1 6 4500 5:00



## 21 Accelerazione centrifuga relativa (RCF)

L'accelerazione centrifuga relativa (RCF) è indicata come un multiplo dell'accelerazione terrestre (g). È un valore numerico privo di unità e funge per paragonare le prestazioni di separazione de sedimentazione.

Il calcolo viene eseguito in base alla formula:

$$RCF = \left( \frac{RPM}{1000} \right)^2 \times r \times 1,118 \quad \Rightarrow \quad RPM = \sqrt{\frac{RCF}{r \times 1,118}} \times 1000$$

RCF = accelerazione centrifuga relativa

RPM = numero dei giri

r = raggio di centrifugazione in mm = distanza dal centro dell'asse di rotazione fino al fondo del recipiente di centrifugazione. Raggio di centrifugazione vedi al capitolo "Anhang/Appendix, Rotoren und Zubehör/Rotors and accessories".



L'accelerazione centrifuga relativa (RCF) dipende dal numero dei giri e dal raggio di centrifugazione.

## 22 Centrifugazione di sostanze o di miscele di sostanze con densità maggiore di 1,2 kg/dm<sup>3</sup>

In caso di centrifugazione con massimo numero di giri, la densità dei materiali o delle miscele di materiali non deve superare il valore di composizione di 1,2 kg/dm<sup>3</sup>.

Con sostanze o miscele di sostanze di densità maggiore, il regime di rotazione deve venire ridotto.

Il numero di giri consentito si calcola con la formula seguente:

$$\text{numero di giri ridotto (n}_{red}\text{)} = \sqrt{\frac{1,2}{\text{densità maggiore [kg/dm}^3\text{]}}} \times \text{regime massimo di rotazione [RPM]}$$

p.es.: regime massimo di rotazione RPM 4000, densità 1,6 kg/dm<sup>3</sup>

$$n_{red} = \sqrt{\frac{1,2 \text{ kg/dm}^3}{1,6 \text{ kg/dm}^3}} \times 4000 \text{ RPM} = 3464 \text{ RPM}$$

In caso di dubbio, rivolgersi al costruttore per maggiori informazioni.

## 23 Sbloccaggio di emergenza

Nel caso di uscita di servizio della corrente il coperchio non può venire sbloccato motoricamente. Deve essere eseguito uno sbloccaggio di emergenza di tipo manuale.



Per lo sbloccaggio di emergenza staccare la centrifuga dalla rete di alimentazione.  
Aprire il coperchio solo a rotore fermo.



ATTENZIONE! Danneggiamento della chiusura, durante lo sbloccaggio di emergenza, quando la chiave a forchetta esagonale viene girata in senso orario (verso destra).  
La rotazione della chiave a forchetta esagonale è ammessa solo in senso antiorario (verso sinistra), vedere illustrazione.

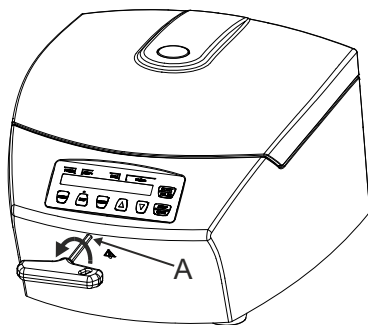

- Disinserire l'interruttore di rete (posizione di interruttore "0").
- Guardare dalla finestra che si trova sul coperchio per assicurarsi che il rotore sia fermo.
- Introdurre orizzontalmente nel foro (A) la chiave a forchetta esagonale e girare con cautela in senso antiorario (verso sinistra), fino a quando il coperchio si apre.
- Estrarre poi la chiave a forchetta esagonale dal foro.

## 24 Pulizia e manutenzione



L'apparecchiatura può essere contaminata.



Prima della pulizia, staccare la presa di corrente.

Prima di iniziare un procedimento di pulizia e decontaminazione diverso da quello consigliato dal produttore, l'utilizzatore deve accertarsi presso il produttore che tale procedimento previsto non rechi danno all'apparecchio.

- Centrifughe, rotori e accessori non devono essere lavati in lavastoviglie.
- Si deve eseguire solo una pulizia manuale ed una disinfezione con liquido.
- La temperatura dell'acqua deve essere di 20 – 25°C.
- Devono essere utilizzati solo detersivi o disinfettanti che:
  - abbiano un campo di valori del pH che va da 5 a 8,
  - non contengano alcali caustici, perossidi, composti di cloro, acidi e soluzioni alcaline.
- Seguire attentamente le indicazioni speciali del produttore sull'impiego di detersivi e disinfettanti, al fine di evitare qualsiasi fenomeno di corrosione.

### 24.1 Centrifughe (scatola, coperchio e vano di centrifugazione)

#### 24.1.1 Cura e pulizia delle superfici

- Pulire regolarmente il corpo della centrifuga e la camera di centrifugazione e impiegare all'occorrenza sapone o un detersivo delicato e un panno umido. Ciò serve da un lato per l'igiene e dall'altro lato per evitare la corrosione causata da impurità incrostate.
- Ingredienti dei detersivi adatti: sapone, tensidi anionici, tensidi non ionici.
- Dopo l'impiego di detersivi, rimuovere i resti del detersivo pulendo di nuovo con un panno umido.
- Le superfici devono essere asciugate subito dopo la pulizia.
- In caso di formazione di acqua di condensa, asciugare la camera di centrifugazione pulendola con un panno assorbente.
- Spalmare sulla guarnizione di gomma della camera di centrifugazione, frizionando leggermente, polvere di talco o una sostanza per la cura della gomma.
- Controllare una volta l'anno se il vano di centrifugazione presenta danneggiamenti.



Se vengono stabiliti danni rilevanti per la sicurezza, la centrifuga non deve essere più messa in funzione. In questo caso si deve contattare il servizio assistenza clienti.

#### 24.1.2 Disinfezione delle superfici

- In presenza di materiale infettivo nella camera di centrifugazione si deve disinfettarla immediatamente.
- Ingredienti dei disinfettanti adatti: etanolo, alcol n proclitico, etilexanolo, tensidi anionici, inibitori di corrosione.
- Dopo l'impiego di disinfettanti, rimuovere i resti del disinfettante pulendo di nuovo con un panno umido.
- Le superfici devono essere asciugate subito dopo la disinfezione.

#### 24.1.3 Rimuovere contaminazioni radioattive

- La sostanza deve essere certificata in modo speciale per rimuovere contaminazioni radioattive.
- Ingredienti di sostanze adatte alla rimozione di contaminazioni radioattive: tensidi anionici, tensidi non ionici, etanolo poliidrato.
- Dopo aver rimosso le contaminazioni radioattive, rimuovere i resti della sostanza pulendo di nuovo con un panno umido.
- Le superfici devono essere asciugate, subito dopo la rimozione delle contaminazioni radioattive.

## 24.2 Rotori ed accessori

### 24.2.1 Pulizia e cura

- Per prevenire corrosione e alterazioni dei materiali, i rotori e l'accessorio devono essere regolarmente puliti con sapone o con un detergente delicato e con un panno umido. Si consiglia la pulizia almeno una volta la settimana. La sporcizia deve essere subito rimossa.
- Ingredienti dei detergenti adatti:  
sapone, tensidi anionici, tensidi non ionici.
- Dopo l'impiego di detergenti, rimuovere i resti del detergente, risciacquando con acqua (solo al di fuori della centrifuga) o ripulendo con un panno umido.
- I rotori e gli accessori devono essere asciugati immediatamente dopo la pulizia.
- I rotor ad angolo, i contenitori e i supporti in alluminio devono essere ingrassati leggermente con grasso privo d'acidi come ad esempio vaselina quando sono ben asciutti.
- I rotor e gli elementi accessori devono essere verificati settimanalmente per quanto riguarda il loro stato di usura ed i danneggiamenti da corrosione.



Rotori ed accessori non devono essere più utilizzati se presentano consumo o corrosione.

### 24.2.2 Disinfezione

- Se del materiale infetto viene a contatto con i rotor o con gli accessori, allora si deve eseguire una disinfezione adeguata.
- Ingredienti dei disinfettanti adatti:  
etanolo, alcol n proclitico, etilexanolo, tensidi anionici, inibitori di corrosione.
- Dopo l'impiego di disinfettanti, rimuovere i resti del disinfettante, risciacquando con acqua (solo al di fuori della centrifuga) o ripulendo con un panno umido.
- I rotor e gli accessori devono essere asciugati immediatamente dopo la disinfezione.

### 24.2.3 Rimuovere contaminazioni radioattive

- La sostanza deve essere certificata in special modo per rimuovere contaminazioni radioattive.
- Ingredienti di sostanze adatte alla rimozione di contaminazioni radioattive:  
tensidi anionici, tensidi non ionici, etanolo poliidratato.
- Dopo la rimozione delle contaminazioni radioattive, rimuovere la sostanza, risciacquando con acqua (solo al di fuori della centrifuga) o ripulendo con un panno umido.
- I rotor e gli accessori devono essere asciugati subito dopo la rimozione delle contaminazioni radioattive.

### 24.2.4 Rotori ed accessori con limitata durata di impiego

L'impiego di particolari rotor, ganci ed elementi accessori è limitato nel tempo.

Questi sono contrassegnati con la quantità max. di cicli di funzionamento o dalla data di scadenza ed il numero massimo di cicli di funzionamento o solo con la data di scadenza, p.es.:

- "usable until end of month/year: 10/2024" (utilizzabile fino alla fine del mese/anno: 10/2024)
- "max. cycles: 40000". (max. cicli operativi: 40000).



Per motivi di sicurezza l'impiego dei rotor, dei ganci e degli elementi di accessorio non è più ammesso, quando è raggiunta la quantità massima permessa dei cicli di funzionamento che è sopracontrassegnata o quando è raggiunta la data di scadenza sopracontrassegnata.

La centrifuga è dotata di un contatore cicli, che conteggia i cicli operativi (processi di centrifugazione) dei diversi codici di rotore. Per la descrizione vedere al capitolo "Contatore cicli".

### 24.3 Mantenere in autoclave

Il seguente accessorio può essere sterilizzato in autoclave a 121°C / 250°F (20 min):

- Rotori di smorzamento senza ganci
- Riduzioni

Non è possibile fare nessuna dichiarazione sul grado di sterilizzazione.



La conservazione in autoclave accelera il processo di invecchiamento del materiale in plastica. Inoltre può causare variazioni di colore nel materiale in plastica.

### 24.4 Contenitori centrifuga

- In caso di mancanza di tenuta o dopo la rottura dei contenitori per centrifugazione, rimuovere completamente i frammenti dei contenitori, le schegge di vetro e il centrifugato fuoriuscito.
- Dopo la rottura di parti in vetro, sostituire gli inserti di gomma e i manicotti di plastica dei rotor.



Le schegge di vetro rimaste causano ulteriori rotture!

- Nel caso di materiale infettivo, bisogna provvedere immediatamente ad una disinfezione.

## 25 Guasti

Se non si riesce a eliminare l'errore seguendo le indicazioni della tabella guasti, informare il servizio assistenza clienti.

Si prega di indicare il tipo di centrifuga e il numero di serie. Entrambi i numeri sono visibili sulla targhetta di modello della centrifuga.

	<p>Esecuzione di un RESET RETE:</p> <ul style="list-style-type: none"> <li>- Disinserire l'interruttore di rete (posizione interruttore "0").</li> <li>- Attendere almeno 10 secondi quindi reinserire l'interruttore di rete (posizione interruttore "1").</li> </ul>
---	--

Visualizzazione/guasto		Causa	Eliminazione
Nessun indicatore		Assenza di tensione Scatto del fusibile di sicurezza per sovracorrente.	<ul style="list-style-type: none"> <li>- Controllare la tensione di alimentazione.</li> <li>- Controllare i fusibili di ingresso di rete, vedere il capitolo "Sostituzione fusibili entrata rete".</li> <li>- Interruttore generale ACCESO.</li> </ul>
IMBALANCE		Il rotore è caricato in modo non uniforme.	<ul style="list-style-type: none"> <li>- Aprire il coperchio dopo che il rotore si è fermato.</li> <li>- Controllare il caricamento del rotore, vedere il capitolo "Carico del rotore".</li> <li>- Ripetere il ciclo di centrifugazione.</li> </ul>
RPM > ROTOR MAX		Il numero di giri nel programma selezionato è superiore al numero di giri massimo del rotore.	<ul style="list-style-type: none"> <li>- Verificare e correggere la velocità nel programma selezionato.</li> </ul>
MAINS INTERRUPT		Interruzione di rete durante il ciclo di centrifugazione. (Il ciclo di centrifugazione non viene terminato.)	<ul style="list-style-type: none"> <li>- Aprire il coperchio dopo che il rotore si è fermato.</li> <li>- Premere tasto .</li> <li>- All'occorrenza ripetere il ciclo di centrifugazione.</li> </ul>
Rxxx WRONG ROTOR (xxx = Anzeige des Rotorcodes)		Il rotore utilizzato non è omologato per questa apparecchiatura.	<ul style="list-style-type: none"> <li>- Applicare un rotore che sia omologato per questa apparecchiatura.</li> </ul>
KEYBOARD ERROR		Guasto/difetto sistema elettronico.	<ul style="list-style-type: none"> <li>- Dopo l'arresto del rotore eseguire un RESET RETE.</li> </ul>
TACHO ERROR	1, 2, 96.1	Mancanza degli impulsi del numero di giri durante il funzionamento. Non è applicato alcun rotore Guasto/difetto sistema elettronico.	<ul style="list-style-type: none"> <li>- Una volta decorso il tempo di attesa indicato (150 secondi) eseguire un RESET DI RETE.</li> <li>- Verificare, se il rotore è applicato.</li> </ul>
LID ERROR	4.1 – 4.127	Errore blocco coperchio, ovvero chiusura coperchio.	<ul style="list-style-type: none"> <li>- Dopo l'arresto del rotore eseguire un RESET RETE..</li> </ul>
OVER SPEED	5	N° giri eccedente	
ROTOR ERROR	10.1 – 10.6	Errore codifica rotore	
VERSION ERROR	12	Riconosciuto un modello di centrifuga sbagliato. Guasto/difetto sistema elettronico.	
UNDER SPEED	13	N° giri insufficiente	

Visualizzazione/guasto		Causa	Eliminazione
CTRL ERROR	22 – 25.4	Guasto/difetto sistema elettronico.	– Dopo l'arresto del rotore eseguire un RESET RETE.
CRC ERROR	27, 27.1		
COM ERROR	31 – 36		
FC ERROR	60, 61.1 – 61.21, 61.64 – 61.142		
TACHO ERR	61.22	Errore misurazione regime di rotazione	– Il disinserimento dell'apparecchiatura non è ammesso, per il tempo in cui viene esposto il messaggio "Wait". Una volta che il messaggio "wait ...!" non è più esposto, eseguire un RESET DI RETE.
FC ERROR	61.23		
FC ERROR	61.153	Guasto/difetto sistema elettronico.	– Esecuzione di un RESET RETE. – Controllare il caricamento del rotore, vedere il capitolo "Carico del rotore". – Ripetere il ciclo di centrifugazione.
VERS. ERR	61.154	Versione di macchina non valida	– Esecuzione di un RESET RETE.

## 26 Sostituzione fusibili entrata rete



Spegnere l'interruttore di rete e staccare l'apparecchio dall'alimentazione!

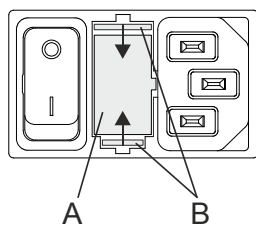

Il portafusibili (A) con i fusibili d'entrata rete si trova accanto all'interruttore di rete.

- Estrarre il cavo di collegamento dalla spina.
- Premere la chiusura a scatto (B) contro il portafusibili (A) ed estrarre quest'ultimo.
- Sostituire i fusibili di rete difettosi.



Utilizzate solo fusibili con valori nominali fissati per il rispettivo tipo, vedere la successiva tabella.

- Inserire di nuovo il portafusibili fino a far scattare la chiusura.
- Allacciare di nuovo l'apparecchio alla rete.

Modello	Tipo	Fusibile	N° ord.
EBA 280	1101	T 3,15 AH/250V	E997
EBA 280 S	1102	T 3,15 AH/250V	E997
EBA 280	1101-01	T 6,3 AH/250V	2266
EBA 280 S	1102-01	T 6,3 AH/250V	2266

## 27 Rispedizione di apparecchi



Prima di rispedire un apparecchio deve essere montata la protezione per il trasporto.

Se l'apparecchio o uno dei suoi accessori viene rispedito alla ditta Andreas Hettich GmbH & Co. KG, esso deve essere prima decontaminato e pulito per la tutela di persone, ambiente e materiale.

Ci riserviamo la facoltà di accettare apparecchi o accessori contaminati.

Eventuali costi di pulizia e disinfezione verranno fatturati al cliente.

Contiamo a questo riguardo sulla vostra comprensione.

## 28 Smaltimento

Prima dello smaltimento, l'apparecchiatura deve essere decontaminata e pulita con lo scopo di proteggere le persone, l'ambiente e il materiale.

Per lo smaltimento dell'apparecchio osservare le rispettive norme di legge.

Ai sensi della direttiva 2002/96/CE (RAEE) tutti gli apparecchi forniti dopo il 13/08/2005 non possono più essere smaltiti con i rifiuti domestici. Questo apparecchio appartiene alla categoria 8 (Dispositivi medicali) ed è classificato nel settore Business-to-Business.











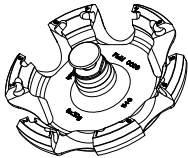
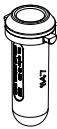
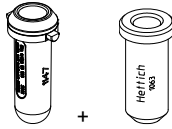















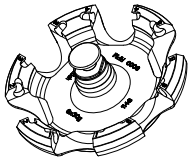
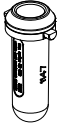
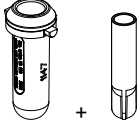

Il simbolo della pattumiera cancellata con una croce indica che l'apparecchio non deve essere smaltito con i rifiuti domestici.

Le norme per lo smaltimento possono essere differenti nei singoli paesi UE. In caso di necessità rivolgersi al proprio rivenditore.

29 Anhang / Appendix







29.1 Rotoren und Zubehör / Rotors and accessories



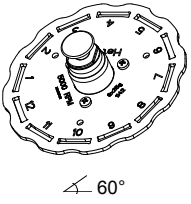
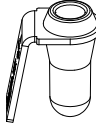







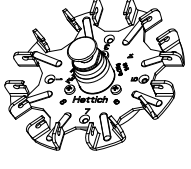

1146		1147							1147 + 1063			
<b>Ausschwingrotor 6-fach / Swing out rotor 6-times</b>  $\angle 90^\circ$ EBA 280: 4700 RPM EBA 280S: 6000 RPM												
		0518									2078	0536
												
Kapazität / capacity	ml	15	4,9	4,5 - 5	7,5 - 8,5	9 - 10	4 - 7	8,5 - 10	12	0,5	1,5	2,0
Maße / dimensions	$\varnothing \times L$ mm	17 x 100	13 x 90	11 x 92	15 x 92	16 x 92	13 x 100	16 x 100	17 x 102	10,7 x 36	11 x 38	11 x 38
Anzahl p. Rotor / number p. rotor		6										
Drehzahl / speed	RPM	4700 / 6000										
RZB / RCF	<sup>2)</sup>	3112 / 5071							1877 / 3059	1902 / 3099		
Radius / radius	mm	126										
 9 (97%)	sec								9 / 11			
 9	sec								11 / 13			
Probenerwärmung / Sample temp. rise	K <sup>1)</sup>								10 / 15			

1146		1147				1147 + 1053						
<b>Ausschwingrotor 6-fach / Swing out rotor 6-times</b>  $\angle 90^\circ$ EBA 280: 4700 RPM EBA 280S: 6000 RPM												
				0501+0767	0553	---						
												
Kapazität / capacity	ml	4	4 - 5,5	6	5	1,1 - 1,4	2,7 - 3	2,6 - 3,4	1,6 - 5,0	4 - 7		
Maße / dimensions	$\varnothing \times L$ mm	10 x 88	15 x 75	12 x 82	12 x 75	13 x 75	8 x 66	11 x 66	13 x 65	13 x 75	16 x 75	
Anzahl p. Rotor / number p. rotor		6										
Drehzahl / speed	RPM	4700 / 6000										
RZB / RCF	<sup>2)</sup>	3112 / 5071		2865 / 4669		2816 / 4266						
Radius / radius	mm	126		116		106						
 9 (97%)	sec								9 / 11			
 9	sec								11 / 13			
Probenerwärmung / Sample temp. rise	K <sup>1)</sup>								10 / 15			

- |   |  |
|---|--|
| 1) Probenerwärmung bei maximaler Drehzahl und 1 Stunde Laufzeit | 1) Sample temp. rise during maximum speed and 1 hour running time          |
| 2) Zentrifugiergefäße aus Glas nur belastbar bis RZB 4000       | 2) Centrifuge containers of glass will not stand RCF values exceeding 4000 |











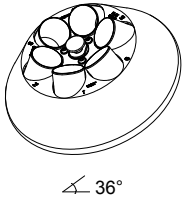







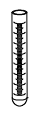

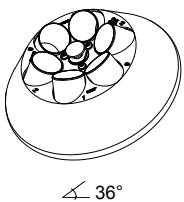

1142	1127-A							
<b>Ausschwingrotor 12-fach / Swing out rotor 12-times</b>   60°								
	0553							
								
Kapazität / capacity ml	5	1,6 - 5	2,6 - 3,4	2,7 - 3				
Maße / dimensions Ø x L mm	13 x 75	13 x 75	13 x 65	11 x 66				
Anzahl p. Rotor / number p. rotor	12							
Drehzahl / speed RPM	5000							
RZB / RCF	2963							
Radius / radius mm	106							
 9 (97%) sec	10							
 9 sec	12							
Probenerwärmung/Sample temp. rise K <sup>1)</sup>	10							

1148	1131-A				1132-A			
<b>Ausschwingrotor 8-fach / Swing out rotor 8-times</b>   90°								
	0553				0501		2079	
								
Kapazität / capacity ml	5	1,6 - 5	2,6 - 3,4	2,7 - 3	6	4 - 5,5	10	4 - 7
Maße / dimensions Ø x L mm	13 x 75	13 x 75	13 x 65	11 x 66	12 x 82	15 x 75	17 x 70	16 x 75
Anzahl p. Rotor / number p. rotor	8							
Drehzahl / speed RPM	5000							
RZB / RCF	2991							
Radius / radius mm	107							
 9 (97%) sec	8							
 9 sec	10							
Probenerwärmung/Sample temp. rise K <sup>1)</sup>	9							

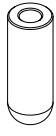
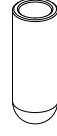
- 1) Probenerwärmung bei maximaler Drehzahl und 1 Stunde Laufzeit
- 2) Zentrifugiergefäße aus Glas nur belastbar bis RZB 4000

- 1) Sample temp. rise during maximum speed and 1 hour running time
- 2) Centrifuge containers of glass will not stand RCF values exceeding 4000

1137		1634		1633		1635			
<b>Winkelrotor 6-fach / Angle rotor 6-times</b>  36°		---							
		0521	0546	0519	0545			0518	
									
Kapazität / capacity	ml	50	50	25	30	9-10	10	15	4 - 7
Maße / dimensions	∅ x L mm	34 x 100	29 x 107	24 x 100	26 x 95	16 x 92	15 x 102	17 x 100	13 x 100
Anzahl p. Rotor / number p. rotor		6							
Drehzahl / speed	RPM	6000							
RZB / RCF	<sup>2)</sup>	4025	3904	3703	3703	3783	3783	3783	
Radius / radius	mm	100	97	92	92	94	94	94	
 9 (97%)	sec	20							
 9	sec	17							
Probenerwärmung/Sample temp. rise	K <sup>1)</sup>	7							











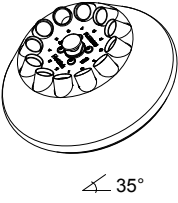

1137		1632	1641	1631	1635 + 1054-A		
<b>Winkelrotor 6-fach / Angle rotor 6-times</b>  36°							
		0578	0513	0509			
							
Kapazität / capacity	ml	7	50	15	1,6 – 5,0		
Maße / dimensions	∅ x L mm	12 x 100	29 x 115	17 x 120	13 x 75		
Anzahl p. Rotor / number p. rotor		18	3	6	6		
Drehzahl / speed	RPM	6000					
RZB / RCF	<sup>2)</sup>	3944	3824	3824	2978		
Radius / radius	mm	98	95	95	74		
 9 (97%)	sec	20					
 9	sec	17					
Probenerwärmung/Sample temp. rise	K <sup>1)</sup>	7					











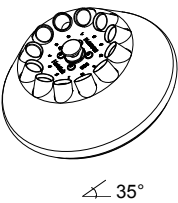

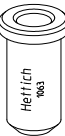





1) Probenerwärmung bei maximaler Drehzahl und 1 Stunde Laufzeit

2) Zentrifugiergefäße aus Glas nur belastbar bis RZB 4000

1) Sample temp. rise during maximum speed and 1 hour running time







2) Centrifuge containers of glass will not stand RCF values exceeding 4000

1139		1054-A								
<b>Winkelrotor 12-fach / Angle rotor 12-times</b>  35°										---
		0553	---							0518
				 3)						
Kapazität / capacity	ml	5		12	1,6 – 5,0	1,1 – 1,4	2,6 – 3,4	2,7 - 3	4	15
Maße / dimensions	Ø x L	12 x 75	13 x 75	17 x 102	13 x 75	8 x 66	13 x 65	11 x 66	12 x 60	17 x 100
Anzahl p. Rotor / number p. rotor		12								
Drehzahl / speed	RPM	6000								
RZB / RCF	<sup>2)</sup>	3300	4146	3300	3300	3300	3300	3300	3260	4146
Radius / radius	mm	82	103	82	82	82	82	82	81	103
 9 (97%)	sec	16								
 9	sec	16								
Probenerwärmung/Sample temp. rise	K <sup>1)</sup>	6								

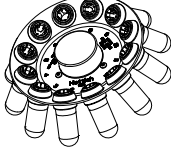
1139							1058			1063				6305
<b>Winkelrotor 12-fach / Angle rotor 12-times</b>  35°														
											0509	0507		
														
Kapazität / capacity	ml	4,5 - 5	4,9	7,5 – 8,5	9 - 10	10	4 - 7	8	8,5 - 10	0,5	15		4	
Maße / dimensions	Ø x L	11 x 92	13 x 90	15 x 92	16 x 92	15 x 102	13 x 100	16 x 125	16 x 100	10,7 x 36	17 x 120	17 x 100	10 x 88	
Anzahl p. Rotor / number p. rotor		12	12	12	12	12	12	6	12	12	6	12	12	
Drehzahl / speed	RPM	6000												
RZB / RCF	<sup>2)</sup>	4146	4146	4146	4146	4146	4146	4146	4146	2777	4146	4146	3502	
Radius / radius	mm	103	103	103	103	103	103	103	103	69	103	103	87	
 9 (97%)	sec	16												
 9	sec	16												
Probenerwärmung/Sample temp. rise	K <sup>1)</sup>	6												

- 1) Probenerwärmung bei maximaler Drehzahl und 1 Stunde Laufzeit
- 2) Zentrifugiergefäße aus Glas nur belastbar bis RZB 4000
- 3) ohne Deckel

- 1) Sample temp. rise during maximum speed and 1 hour running time
- 2) Centrifuge containers of glass will not stand RCF values exceeding 4000
- 3) without lid

1133							
<b>Winkelrotor 12-fach / (mit Dekantierhilfe) Angle rotor 12-times (with decanter aid)</b>  $\angle 35^\circ$		0553	0501	0578			
							
Kapazität / capacity	ml	5	6	7			
Maße / dimensions	Ø x L mm	12 x 75	12 x 82	12 x 100			
Anzahl p. Rotor / number p. rotor		12					
Drehzahl / speed	RPM	5000					
RZB / RCF	)	2879					
Radius / radius	mm	103					
 9 (97%)	sec	8					
 9	sec	10					
Probenerwärmung/Sample temp. rise	K <sup>1)</sup>	18					

1) Probenerwärmung bei maximaler Drehzahl und 1 Stunde Laufzeit

1) Sample temp. rise during maximum speed and 1 hour running time