



Thermo Scientific

# Medifuge

Small Benchtop Centrifuge

## Instruction Manual

50148677-d • 11 / 2015

# Table of Contents

<b>Preface</b> .....	<b>5</b>
<b>Intended Use</b> .....	<b>5</b>
<b>Items Supplied</b> .....	<b>6</b>
<b>Precautions</b> .....	<b>7</b>
Signal Words and Colors .....	7
Set Up Conditions .....	7
Shutdown .....	7
Preparation .....	8
Hazardous Substances .....	8
Operation .....	9
Maintenance .....	9
Service Lifetime .....	10
<b>Symbols used on the Centrifuge</b> .....	<b>11</b>
<b>Symbols used in the Manual</b> .....	<b>11</b>
<b>I. Technical Specifications</b> .....	<b>12</b>
<b>1. Technical Data</b> .....	<b>12</b>
Thermo Scientific Medifuge Centrifuge .....	12
Thermo Scientific DualSpin Rotor .....	13
<b>2. Rotor and Accessories</b> .....	<b>14</b>
<b>3. Directives, Standards and Guidelines</b> .....	<b>15</b>
<b>4. Mains Supply</b> .....	<b>16</b>
<b>II. Transport and Set Up</b> .....	<b>17</b>
<b>1. Before Setting Up</b> .....	<b>17</b>
<b>2. Location</b> .....	<b>17</b>
<b>3. Transporting</b> .....	<b>18</b>
<b>4. Leveling</b> .....	<b>18</b>
<b>5. Mains Connection</b> .....	<b>19</b>

- 6. Storage . . . . . 19**
- 7. Shipping . . . . . 20**
- III. Control Panel . . . . . 21**
  - Control Panel Settings . . . . . 22**
    - Select RPM/RCF. . . . . 22
    - Select Runtime. . . . . 24
    - Acceleration / Deceleration Profiles. . . . . 25
    - Programs. . . . . 26
- IV. Operation . . . . . 27**
  - 1. Switching on the Centrifuge . . . . . 27**
  - 2. Open the Centrifuge Door . . . . . 27**
  - 3. Rotor Installation . . . . . 28**
    - Installation of Swing Out Buckets . . . . . 30
  - 4. Rotor Temperature Range . . . . . 31**
  - 5. Rotor Loading . . . . . 31**
    - Maximum Loading . . . . . 33
    - Tube and Spacer Guide . . . . . 34
    - Swing Out Bucket . . . . . 38
    - Checking the Rotor Lifetime . . . . . 40
  - 6. Close the Centrifuge Door . . . . . 41**
  - 7. Centrifugation. . . . . 42**
    - Before a Run . . . . . 42
    - Starting the Centrifugation . . . . . 42
    - Stopping the Centrifugation . . . . . 43
  - 8. Removing the Rotor . . . . . 44**
  - 9. Switch off the Centrifuge. . . . . 44**
- V. Maintenance and Care . . . . . 45**
  - 1. Cleaning Intervals . . . . . 45**
  - 2. Basics . . . . . 46**

<b>3. Cleaning</b> .....	<b>47</b>
<b>4. Disinfection</b> .....	<b>48</b>
<b>5. Decontamination</b> .....	<b>49</b>
<b>6. Service of Thermo Fisher Scientific</b> .....	<b>50</b>
<b>7. Shipping and Disposal</b> .....	<b>51</b>
<b>VI. Troubleshooting</b> .....	<b>52</b>
<b>1. Mechanical Emergency Door Release</b> .....	<b>52</b>
<b>2. Troubleshooting by Guide</b> .....	<b>53</b>
<b>3. When to contact Customer Service</b> .....	<b>54</b>
<b>Chemical Compatibility Chart</b> .....	<b>55</b>
<b>Declaration of Decontamination</b> .....	<b>68</b>
<b>Acceleration/Deceleration Profiles</b> .....	<b>70</b>
<b>Index</b> .....	<b>71</b>



## Preface

Before using the centrifuge, read through this instruction manual carefully and follow the instructions. Not following the instructions and safety information in this instruction manual will result in the expiration of the sellers warranty.

## Intended Use

This centrifuge is intended to be used as a laboratory equipment to separate sample mixtures of different densities.

This centrifuge can be used as an In-Vitro diagnostics device (Directive 98/79/EC), if used together with IVD tubes, to separate blood into its components such as serum and plasma for further clinical diagnostic analysis.





The centrifuge has to be operated by a trained individual such as a clinical laboratory technologist or a trained laboratory technician.

## Items Supplied

The Thermo Scientific™ Medifuge™ small benchtop centrifuge is supplied with a rotor and 2 bucket sets.

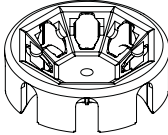
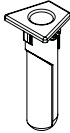
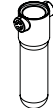

Size and relation of graphics are not showing real dimensions and are just for visual identification.

If any parts are missing, please contact the nearest Thermo Fisher Scientific representative.

Article No.	Item	Graphic	Quantity
<b>Centrifuge</b>			
	Thermo Scientific Medifuge small benchtop centrifuge		1
	Power supply cable		1
<b>Rotor</b>			
75008810	Thermo Scientific™ DualSpin™ rotor (factory installed) with fixed angle and swinging buckets sets, including:		1
	Fixed angle buckets		8
	Swing out buckets		8
50148478	Rotor locking nut (factory installed)		1
75008817	Spacers (short & green)		8
75008818	Spacers (long & yellow)		8
50149182	Hex key (tool for emergency lid lock)		1
	Instruction manual		1
	CD		1

## Precautions

### Signal Words and Colors

 <b>WARNING</b>	Indicates a hazardous situation that, if not avoided, could result in death or serious injury.
 <b>CAUTION</b>	Indicates a hazardous situation that, if not avoided, could result in minor or moderate injury (e.g. sample loss).
<b>NOTICE</b>	Indicates information considered important, but not hazard-related (e.g. messages relating to property damage).

#### **NOTICE**

Observe the safety instructions. Not following these instructions can cause damage.

The centrifuge is to be used for its intended use only. Improper use can cause damages, contamination, and injuries with fatal consequences.

### Set Up Conditions

- Set up in a well-ventilated environment, on a horizontally levelled and rigid surface with adequate load-bearing capacity.
- As safety zone maintain a clear radius of at least 30 cm around the centrifuge. Do not place any dangerous substances within this security zone.
- Plug the centrifuge only into sockets which have been properly grounded.
- The mains plug must be freely accessible at any time.

#### **CAUTION**

Not following the set up conditions can result in minor or serious injuries.

### Shutdown

Turn off the centrifuge at the main switch.

The mains plug must be freely accessible at any time.

Press the STOP key to shut down the centrifuge.

Pull out the power supply plug or disconnect the power supply in an emergency.

## Preparation

- Use only with a rotor that has been properly installed. Follow the instructions in section “Rotor Installation” on page 28.
- Do not use a rotor or accessories that show any signs of corrosion or cracks. Contact customer service for further advice or inspections.
- Use only with a rotor that has been properly loaded.
- Never overload the rotor.
- Always balance the samples.
- Use only rotors and accessories for this centrifuge that have been approved by Thermo Fisher Scientific.
- Make sure the rotor is locked properly into place before operating the centrifuge.

### **WARNING**

It is the obligation of the operator to make sure, that protective clothing is used. Mind the “Laboratory Biosafety Manual” of the World Health Organization (WHO) and the regulations in your country.

### **CAUTION**

- Implement measures which ensure that no one can approach the centrifuge for longer than absolutely necessary while it is running.
- Do not use a damaged rotor. Replace the rotor, if it was dropped.

## Hazardous Substances

### **WARNING**

- Especially when working with corrosive samples (salt solutions, acids, bases), the accessory parts and vessel have to be cleaned thoroughly.
- Do not centrifuge explosive or flammable materials or substances.
- The centrifuge is not inert or protected against explosion. Never use the centrifuge in an explosion-prone environment.
- Do not centrifuge toxic or radioactive materials or any pathogenic micro-organisms without suitable safety precautions.

If any hazardous materials are centrifugated, mind the “Laboratory Biosafety Manual” of the World Health Organization (WHO) and any local regulations. When centrifuging microbiological samples from the Risk Group II (according to the “Laboratory Biosafety Manual” of the World Health Organization (WHO)), aerosol-tight biological seals have to be used. Look on the internet page of the World Health Organization ([www.who.int](http://www.who.int)) for the “Laboratory Biosafety Manual”. For materials in a higher risk group, extra safety measures have to be taken.

- If toxins or pathogenic substances have contaminated the centrifuge or its parts, appropriate disinfection measures have to be taken ("[Disinfection](#)" on page 48).
- Extreme care should be taken with highly corrosive substances which can cause damage and impair the mechanical stability of the rotor. These should only be centrifuged in fully sealed tubes.
- **If a hazardous situation occurs, turn off the power supply to the centrifuge and leave the area immediately.**

## Operation

### **WARNING**

- Never use the centrifuge if parts of its cover panels are damaged or missing.
- Do not move the centrifuge while it is running.
- Do not place anything on top of the centrifuge during a run.

### **CAUTION**

- Do not lean on the centrifuge.
- Never open the centrifuge door until the rotor has come to a complete stop and this has been confirmed in the display.
- The emergency door release may be used in emergencies only to recover the samples from the centrifuge, e.g. during a power failure ("[Mechanical Emergency Door Release](#)" on page 52).

### **NOTICE**

In any case of severe mechanical failure, such as a rotor crash, the centrifuge is not aerosol-tight. In case of rotor failure the centrifuge can be damaged. Leave the room. Inform customer service.

## Maintenance

### **WARNING**

- The centrifuge housing is not to be opened by the operator.
- Do not change or replace mechanical or electrical components. Changing or replacing components can result in death or serious injury.

## Service Lifetime

The centrifuge is designed for 10 years or 140 000 cycles of service, whichever is first. Usage beyond these limits might affect the safety of the centrifuge housing or the lid latch system.

The rotor is designed for 5 years or 60 000 cycles of service, whichever is first. Usage beyond these limits might lead to rotor failure, sample loss and damage to the centrifuge.

## Symbols used on the Centrifuge



This symbol refers to general hazards.



This symbol refers to biological hazards.

Observe the information contained in the instruction manual to keep yourself and your environment safe.



This symbol refers to physical hazards from hot surfaces.



This symbol refers to information on hazards, described within the manual.



This symbol demands to disconnect mains before transporting or servicing the centrifuge.

## Symbols used in the Manual



This symbol refers to general hazards.



This symbol refers to biological hazards.

Observe the information contained in the instruction manual to keep yourself and your environment safe.

# I. Technical Specifications

## 1. Technical Data



### Thermo Scientific Medifuge Centrifuge

Environmental Conditions	For interior use Altitudes of up to 3 000 m above sea level Max. relative humidity 80% up to 31 °C; decreasing linearly to 50% relative humidity at 40 °C
Environmental Conditions during Storage and Shipping	Temperature: -10 °C to +50 °C Humidity: 15% to 85%
Permissible Ambient Temperature during Operation	+2 °C to +40 °C
Heat Dissipation	0.123 kWh; 419.7 Btu/h; 442.8 kJ/h
Overvoltage Category	II
Pollution Degree	2
IP	20
Running Time	99 min; hold
Maximum Speed $n_{\max}$	4 900 rpm
Minimum Speed $n_{\min}$	300 rpm
Maximum RCF Value at $n_{\max}$	
Fixed Angle Setup	3 114 x g
Swing Out Setup	3 490 x g
Noise Level at Maximum Speed <sup>1</sup>	< 56 dB (A)
Maximum Kinetic Energy	680 J
Dimensions	
Height (open door / closed door)	510 mm / 240 mm
Width	325 mm
Depth	450 mm
Weight <sup>2</sup>	15.5 kg

<sup>1</sup> Front Side Measurement, 1 m in front of the instrument at 1.6 m height.

<sup>2</sup> Without Rotor.









## Thermo Scientific DualSpin Rotor

Maximum Permissible Load	8 x 30 g
Maximum Allowed Imbalance	10 g
Maximum Speed $n_{max}$	4 900 rpm
Maximum RCF-Value at $n_{max}$	
Fixed Angle Setup	3 114 x g
Swing Out Setup	3 490 x g
Max. Cycle Number	60 000
Radius max. / min.	
Fixed Angle Setup	116 mm / 37 mm
Swing Out Setup	130 mm / 42 mm
Angle	
Fixed Angle Setup	45°
Swing Out Setup	12-87°
Acceleration / Braking Time*	
Fixed Angle Setup	24 s / 37 s
Swing Out Setup	24 s / 31 s
Autoclavable	No

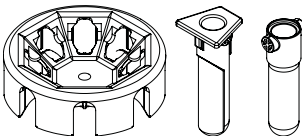
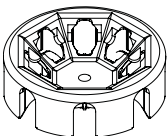
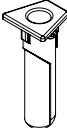
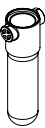
\* Deceleration time at standard curve.

## 2. Rotor and Accessories

Article No.	Description	Graphic
75008810	Thermo Scientific DualSpin rotor (1x) with fixed angle buckets (8x) and swinging buckets (8x)	
75008813	Thermo Scientific DualSpin rotor body (1x)	
75008815	Fixed angle buckets (8x)	
75008816	Swing out buckets (8x)	
50148478	Rotor locking nut	
75008817	Spacers (green, 8x)	
75008818	Spacers (yellow, 8x)	
50149182	Hex key (tool for emergency lid lock)	

### 3. Directives, Standards and Guidelines

Region	Directive	Standard
<b>Europe</b> 220–230 V, 50/60 Hz	<b>98/79/EC</b> In vitro diagnostic medical devices (IVD) <b>2006/95/EC &amp; 2014/35/EC</b> Low Voltage (protective goals) <b>2006/42/EC</b> Machinery (protective goals) <b>2004/108/EC</b> Electromagnetic Compatibility (EMC) (protective goals) <b>2011/65/EC RoHS</b> – Directive on the Restriction of the use of certain Hazardous Substances in electrical and electronic equipment	EN 61010-1, 3 <sup>rd</sup> Edition IEC 61010-2-020, 2 <sup>nd</sup> ed & CDV 61010-2-020 3 <sup>rd</sup> Edition IEC 61010-2-101, 3 <sup>rd</sup> Edition EN 61326-1 Class B EN 61326-2-6 EN 62304 EN 62366 EN ISO 14971 EN ISO 13485
<b>North America</b> (USA & Canada) 230 V, 60 Hz 120 V, 60 Hz	<b>FDA</b> Product Code JQC Device Class 1 Centrifuges for Clinical Use	EN 61010-1, 3 <sup>rd</sup> Edition IEC 61010-2-020, 2 <sup>nd</sup> ed & CDV 61010-2-020 3 <sup>rd</sup> Edition IEC 61010-2-101, 3 <sup>rd</sup> Edition EN 61326-1 Class B EN 61326-2-6 EN 62304 EN 62366 EN ISO 14971 EN ISO 13485
<b>Japan</b> 100 V, 50/60 Hz <b>China</b> 220 V, 50 Hz		EN 61010-1, 3 <sup>rd</sup> Edition IEC 61010-2-020, 2 <sup>nd</sup> ed & CDV 61010-2-020 3 <sup>rd</sup> Edition IEC 61010-2-101, 3 <sup>rd</sup> Edition EN 61326-1 Class B EN 61326-2-6 EN 62304 EN 62366 EN ISO 14971 EN ISO 13485

## 4. Mains Supply

The following table contains an overview of the electrical connection data. This data is to be taken into consideration, when selecting the mains connection socket.

Unit	Thermo Scientific Medifuge small benchtop centrifuge		
Article No.	75008802	75008801	75008800
Mains Voltage	100 V	120 V	220-230 V
Frequency	50/60 Hz	60 Hz	50/60 Hz
Rated Current	1.7 A	1.8 A	1.1 A
Power Consumption	100 W	130 W	130 W
Equipment Fuse	6.3 AT	4 AT	2 AT
Building Fuse	16 AT	16 AT	16 AT

## II. Transport and Set Up

### 1. Before Setting Up

1. Check the centrifuge and the packaging for any shipping damage. Inform the shipping company and Thermo Fisher Scientific immediately if any damage is discovered.
2. Remove the packaging.

**NOTICE** *Dispose of the packaging. Do not reuse it.*

3. Check, if the items supplied are complete (“Items Supplied” on page 6).

The rotor is factory installed and tightened with the rotor locking nut inside the centrifuge. You can only check the rotor and the rotor locking nut by opening the centrifuge door when the centrifuge is connected to the power supply (“Mains Supply” on page 16) and switched on (“Open the Centrifuge Door” on page 27).

If the items supplied are incomplete, please contact Thermo Fisher Scientific.

### 2. Location



#### CAUTION

UV rays reduce the stability of plastics.

Do not subject the centrifuge, rotor and plastic accessories to direct sunlight.

The centrifuge is only to be operated indoors.

The set-up location must fulfill the following requirements:

- A safety zone of at least 30 cm must be maintained around the centrifuge. People and hazardous substances must be kept out of this safety zone while centrifuging.
- The supporting structure must be stable and free of resonance.
- The supporting structure must be suitable for horizontal setup of the centrifuge.
- The centrifuge is not to be exposed to heat and strong sunlight.
- The set-up location must be well-ventilated at all times.

### 3. Transporting



#### WARNING

The centrifuge can be damaged by impact.

Do not operate the centrifuge if an impact occurred.



#### CAUTION

Do not use a damaged rotor.

Replace the rotor, if it was dropped.

Using a damaged rotor can cause a crash.

#### NOTICE

Always remove buckets before transporting the centrifuge.

Buckets can fall into the rotor chamber.

Always make sure that the buckets are in correct position before operation.

Transport the centrifuge upright and with the centrifuge door closed.

### 4. Leveling

The centrifuge is to be placed on horizontal and level supporting structures or benching. If necessary level the supporting structures or benching to level the centrifuge.

Horizontal level has to be checked after moving the centrifuge to a new location.

## 5. Mains Connection



### CAUTION

Plug the centrifuge into grounded electrical sockets only.

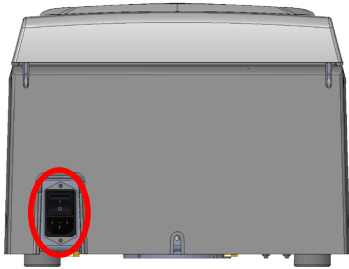

1. Turn off the power supply switch located on the back side.
2. Check whether the cable complies with the safety standards of your country.
3. Make sure that the voltage and frequency correspond to the figures on the rating plate.
4. Establish the connection to the power supply with the connecting cable.

## 6. Storage



### WARNING

When removing the centrifuge and accessories from use, clean and additionally disinfect or decontaminate the entire system if biological or chemical substances were used. If in doubt contact the Thermo Fisher Scientific customer service.

- Before storing the centrifuge and the accessories it must be cleaned and if necessary disinfected and decontaminated.  
Centrifuge, rotor, buckets and accessories have to be thoroughly dried before storage.
- Store the centrifuge in a clean, dust-free location.
- Be sure to place the centrifuge on its feet.
- Avoid storing the centrifuge in direct sunlight.

## 7. Shipping



### WARNING

Before shipping the centrifuge and accessories you have to clean and additionally disinfect or decontaminate the entire system if biological or chemical substances were used. In doubt contact the Thermo Fisher Scientific customer service.

Before shipping the centrifuge please keep the following in mind:

- The centrifuge must be cleaned and decontaminated.
- The decontamination must be confirmed with a decontamination certificate ([“Declaration of Decontamination” on page 68](#)).



### III. Control Panel

No.	Function	Display Controls
1	Speed / RCF Value	The speed (rpm) or RCF value (x g) is displayed here. The RCF value (x g) can be set for the fixed angle buckets (45°) or the swing out buckets (90°). RPM can be set for all bucket set ups.
2	TOGGLE Key for Speed / RCF Value	Use the TOGGLE key to change the display mode. (XG 45° / XG 90° / RPM).
3	Running Time	The running time is displayed here.
4	PULSE Key	Press the PULSE key to immediately start the centrifugation run and accelerate up to the maximal permissible end speed. Releasing the key initiates a stopping process according to the set deceleration profile.
5	OPEN Key	Press the OPEN key to activate the door release (possible only if device is switched on and if the rotor is fully stopped). <a href="#">“Mechanical Emergency Door Release” on page 52.</a>
6	STOP Key	Press the STOP key to manually end the centrifugation run.
7	START Key	Press the START key to start a centrifugation run.
8	Curve Key	Press the key to select “standard” (no LED), “soft dec” or “brake off”.
9	Arrow Keys	Use these keys in order to modify the displayed value of TIME and SPEED.
10	Run Indicator	The LED is active when the rotor is spinning. The LED is inactive when the rotor is in standstill.
11	Program Keys	Use the Program Keys to save and load programs. <a href="#">“Programs” on page 26.</a>

## Control Panel Settings

The centrifuge always shows the actual operating values. Only when changing speed and time the centrifuge will show the set parameters. The centrifuge will show “0” for speed and time, if switched on and it is not operating. An animation will be shown, when the centrifuge is spinning.

### Select RPM/RCF

Speed is shown in Revolutions Per Minute (RPM) multiplied with one thousand (x1000).

Example for 4 900 rpm:

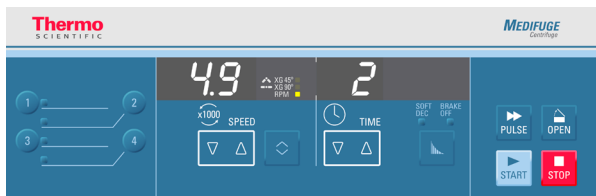

RCF stands for Relative Centrifugal Force and allows better transfer of protocols between centrifuges and rotors of differing size.

Ensure that the rpm or RCF is set correctly.

To save selected parameters as a program: [“Programs” on page 26.](#)

1. Press the TOGGLE key below the SPEED display to cycle through the RPM / RCF selection.

The RPM / RCF selection is divided into “RPM”, “XG 90°” and “XG 45°”.

RPM	Shows the speed in rpm for all bucket set ups.
XG 90°	Shows the RCF value in x g for swing out buckets.
XG 45°	Shows the RCF value in x g for fixed angle buckets.

“XG 90°” and “XG 45°” are available to set the correct RCF for centrifugation with the swing out or the fixed angle buckets. You can also use a mixed bucket set up. That will only show the correct RCF setting for one type of buckets.

**NOTICE** If you switch from rpm to x g it is possible, that the shown value can differ slightly from the exact mathematical calculated value due to rounding effects.

The LED light indicates the selection.

You can switch between rpm and RCF during a run by pressing the TOGGLE key.

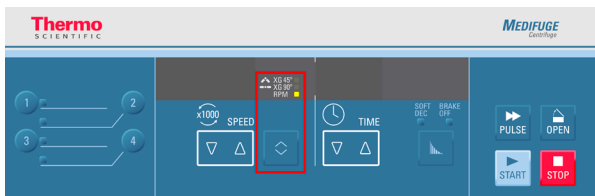

2. Press the SPEED arrow keys. This changes the set centrifugation speed. RPM will change in steps of 100 rpm. RCF will change in steps of 100 x g. Keeping a SPEED arrow key pressed will change the speed until the limiting values are reached. The centrifuge automatically saves the chosen value after 5 seconds or when you change other settings.

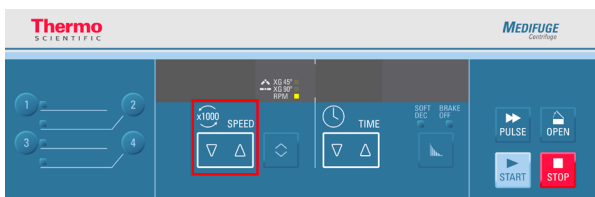

### Explanation of RCF-Value

The relative centrifugal force (RCF) is given as a multiple of the force of gravity g. It is a unitless numerical value which is used to compare the separation or sedimentation capacity of various centrifuges, since it is independent of the type of device. Only the centrifuging radius and the speed are used for calculation:

$$RCF = 11.18 \times \left(\frac{n}{1000}\right)^2 \times r$$

r = centrifuging radius in cm

n = rotational speed in rpm

The maximum RCF value is related to the maximum radius of the tube opening.

Remember that this value is reduced depending on the tubes and buckets used.

This can be accounted for in the calculation above if required.

## Select Runtime

Press the TIME arrow keys. This changes the set centrifugation time.

First runtime will change in steps of single minutes. Holding the key pressed will change the runtime by steps of single minutes. This will continue until the limit of 99 minutes is reached. Keeping the arrow keys pressed at the limits will switch to “hd”. [„Continuous Operation“ on page 24](#)

The centrifuge automatically saves the chosen value after 5 seconds or when you change other settings.

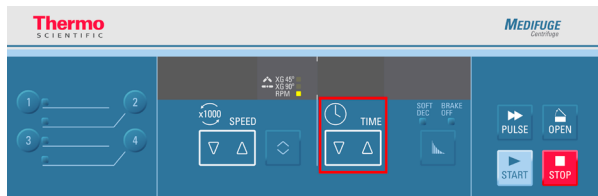

To save selected parameters as a program: [“Programs” on page 26](#).

## Continuous Operation

1. Keep one of the TIME arrow keys pressed until “hd” is displayed.
2. The centrifuge automatically saves the chosen value after 5 seconds or when you change other settings.

## Acceleration / Deceleration Profiles

The centrifuge offers you 1 profile for acceleration (standard) and 3 profiles for deceleration (standard, soft and brake-off). The acceleration profile cannot be changed. The setting is displayed with the LEDs above the Curve Key.

LED Light Settings	Description
OFF (LED Lights off)	Deceleration with max. power
SOFT DEC	Deceleration = soft
BRAKE OFF	Deceleration = no brake

Press the Curve Key to cycle through and set the available profiles. The LEDs show the chosen settings. The last profile is saved, if you restart the centrifuge. The deceleration profile can be changed at any time.

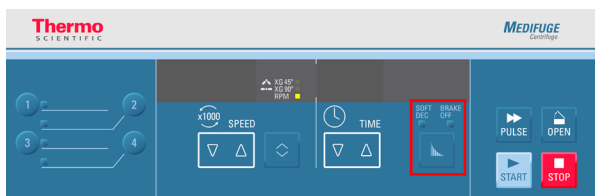

To save selected parameters as a program: [“Programs” on page 26.](#)

## Programs

The centrifuge is able to save up to 4 programs. It is only possible to save a program if the centrifuge is switched on.

Loading or saving of programs is not possible if the centrifuge is spinning.

### Saving a Program

Modify the speed and time to the desired setting.

Press and hold the desired program key for more than 3 seconds.

The display shows "Sd" (saved) and "P" (program) with the chosen number, for example "Sd P1" (saved program 1).

One long acoustic signal can be heard when the program is saved.



### Selecting a Program

Press the program key of the desired program.

The program settings are shown.

The display shows "Ld" (loaded) and "P" (program) with the chosen number, for example "Ld P2" (load program 2).

3 short acoustic signals can be heard when the program is loaded.

The centrifuge now uses the program settings for operation until they are changed.

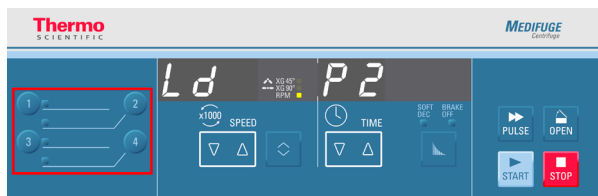

To save selected parameters as a program: ["Programs" on page 26.](#)

## IV. Operation

### 1. Switching on the Centrifuge

Turn on the power switch on the back side of the centrifuge.

The centrifuge door opens automatically, if the centrifuge was closed when when switched on.

### 2. Open the Centrifuge Door



#### CAUTION

Open the centrifuge only when the rotor stopped spinning. The display shows the current speed also during a failure.

In case of a power cut the time until the rotor is in standstill is at least 5 min.

Never reach into the rotor chamber while the rotor is spinning.

The centrifuge door can only be opened when the centrifuge is switched on.

Press the OPEN key on the control panel.

If an error occurs, i.e. during a power failure, it is possible to open the centrifuge door using the mechanical emergency lid lock: "[Mechanical Emergency Door Release](#)" on page 52.

### 3. Rotor Installation



#### CAUTION

The rotor must turn freely and the rotor locking nut must be tight. Check the locking nut regularly to ensure that it is properly tight. If the rotor is not installed correctly, the rotor can crash.



#### CAUTION

Do not use a damaged rotor. Replace the rotor, if it was dropped. Using a damaged rotor can cause a crash.



#### CAUTION

Do not use damaged buckets. Using damaged buckets can cause a crash.

**NOTICE** *The rotor is factory installed.*

Put the rotor body on the motor shaft. Make sure that the thread of the motor shaft is accessible. If rotor body is installed correctly the motor shaft has to be even with the inner rotor topside.

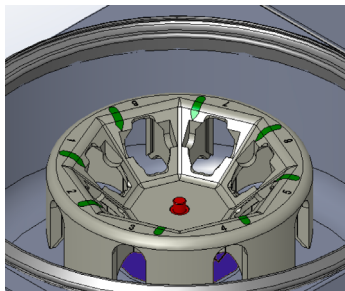

Put the rotor locking nut on the thread of the motor shaft.



## Thermo Scientific Medifuge Centrifuge

Turn the rotor locking nut clockwise.

Tighten the rotor locking nut with your hand.

Make sure that the rotor locking nut is tight by turning it one more complete turn when the rotor locking nut starts to be tight.

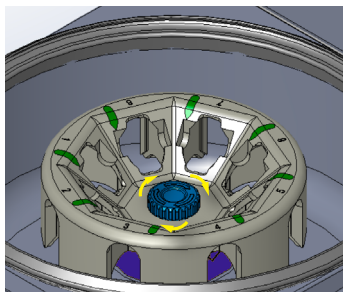

## Installation of Fixed Angle Buckets

Put the fixed angle buckets into the rotor body.

The green printing must align with the printing on the rotor body.

If necessary to get smaller tubes in position, use the spacers (75008818 and 75008817) according to the tubes used.

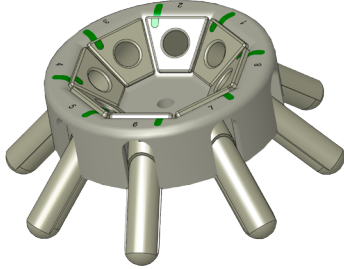

## Installation of Swing Out Buckets

Put the swing out buckets into the rotor body.

The green printing must align with the printing on the rotor body.

If necessary to get smaller tubes in position, use the spacers (75008818 and 75008817) according to the tubes used.

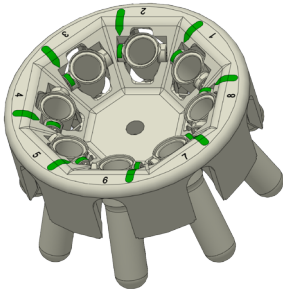

## 4. Rotor Temperature Range



### CAUTION

Operate the rotor in a temperature range between -9 °C and 40 °C only. Pre-cooling in a freezer below -9 °C is not allowed.

### NOTICE

The rotor can warm up at high ambient temperatures. Temperatures above 42 °C can damage blood samples. If necessary let the rotor cool down between two runs.

## 5. Rotor Loading



### CAUTION

An unbalanced rotor can lead to a crash.

All buckets and tubes necessary for a balanced rotor must be in position before the rotor is started.

Always use a balanced rotor.



### CAUTION

Always make sure that the buckets are aligned and the tubes cannot touch each other or the rotor locking nut during centrifugation.

Make sure that opposite positions are always balanced. Balance opposite loads in number of tubes and by position to ensure safe and smooth operation.

Shown pictures are examples for correct and incorrect loading.

## Fixed Angle Buckets

Correct ✓

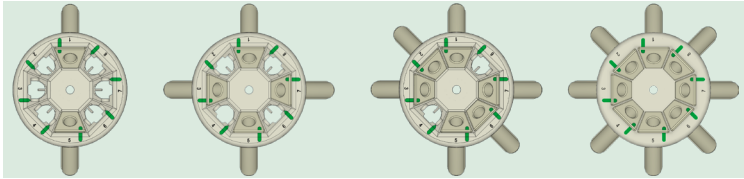

Incorrect ✗

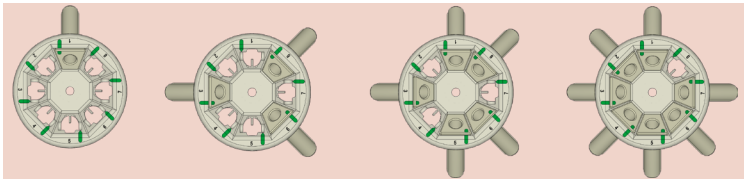

## Swing Out Buckets

Correct ✓

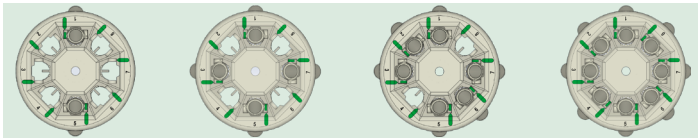

Incorrect ✗

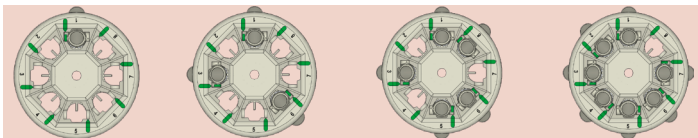

## Mixed Bucket Set Up

Correct ✓

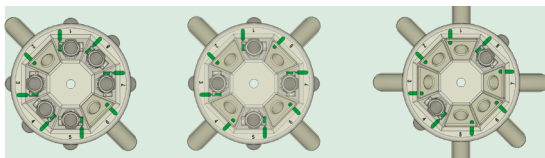

Incorrect ✗

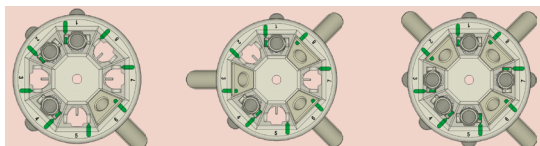

## Maximum Loading

The rotor can run at high speeds. Each rotor is specifically designed to run at its maximum speed with a defined load. The safety system of the centrifuge requires that you do not overload the rotor. The rotor is designed to work with solution with a density of up to 1.2 g/ml. Above this density or if total load is above the maximum weight the following steps should be taken:

- Reduce the fill level.
- Reduce the speed.

Use the table or the formula:

$$n_{adm} = n_{max} \sqrt{\frac{\text{Maximum permissible Load}}{\text{Effective Load}}}$$

$n_{adm}$  = admissible speed

$n_{max}$  = maximum speed

Once the rotor has been properly installed, the main switch turned on and the centrifuge door closed, you may start centrifuging.

## Tube and Spacer Guide



### CAUTION

Always make sure that the buckets are aligned and the tubes cannot touch each other or the rotor locking nut during centrifugation.

This guide provides information on which tubes and spacers can be used in the fixed angle and the swing out buckets. The tubes listed should be checked for proper position and be used according to the specifications of their manufacturers as well as the safety precautions and operating limits described in this manual.

Care should be taken to ensure that the tubes used in the centrifuge are:

- » Rated to or above the selected rcf to be spun at.
- » They are being used at or above their minimum fill volume.
- » They are not being used above their design life (age or number of runs).
- » They are inspected for damage.
- » They are not overloaded.

Refer to manufacturers data sheets for further information.

## Fixed Angle Bucket

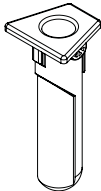
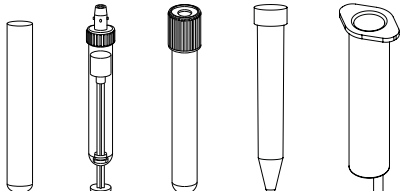
Fixed Angle Bucket				
	Direct Fit (no spacer necessary)			
				
Tube Type	Volume	Diameter	Length	
Sarstedt™ S-Monovette™ blood tube	4.5–5.0 ml	11 mm	92 mm	
Sarstedt S-Monovette blood tube	4.9 ml	13 mm	90 mm	
Sarstedt V-Monovette™ urine tube (round base)	6.0 ml	13 mm	100 mm	
Sarstedt V-Monovette urine tube (round base)	9.5 ml	15 mm	100 mm	
Sarstedt V-Monovette urine tube (conical base)	10.0 ml	15 mm	100 mm	
BD™ Vacutainer™ blood tube	3.5–7.0 ml	13 mm	100 mm	
BD Vacutainer blood tube	7.5–10.0 ml	16 mm	100 mm	
BD CPT tube	4.0 ml	13 mm	100 mm	
BD CPT tube <sup>1</sup>	8.0 ml	16 mm	125 mm	
BD urine tube	8.0 ml	16 mm	100 mm	
Greiner™ VACUETTE™ tube	5.0–6.0 ml	13 mm	100 mm	
Greiner VACUETTE tube	8.0–9.0 ml	16 mm	100 mm	
Glass tubes (DIN)	7.0 ml	12 mm	100 mm	
Glass tubes (DIN)	15.0 ml	16 mm	100 mm	
Glass tubes	15.0 ml	16 mm	125 mm	
Glass tubes	10.0 ml	16 mm	100 mm	
Open tube	15.0 ml	17 mm	100 mm	
Conical cell culture tube	15.0 ml	17 mm	120 mm	
Standard syringe	10.0 ml	17.5 mm	85 mm	
Generic tube <sup>2</sup>	-	17.5 mm	105–125 mm	

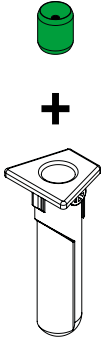
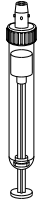
Fixed Angle Bucket		Green Spacer			
					
	Tube Type	Volume	Diameter	Length	
	Sarstedt S-Monovette blood tube	7.5–8.2 ml	15 mm	92 mm	
	Sarstedt S-Monovette blood tube	9.0–10.0 ml	16 mm	92 mm	
Generic tube <sup>2</sup>	-	17.5 mm	90–100 mm		



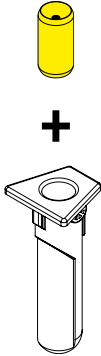
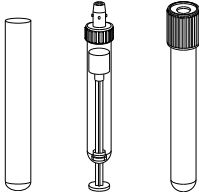

Fixed Angle Bucket		Yellow Spacer			
					
	Tube Type	Volume	Diameter	Length	
	Sarstedt S-Monovette blood tube	1.2–1.4 ml	8 mm	66 mm	
	Sarstedt S-Monovette blood tube	2.6–4.3 ml	13 mm	65 mm	
	Sarstedt S-Monovette blood tube	2.7–3.0 ml	11 mm	66 mm	
	Sarstedt S-Monovette blood tube	2.7–4.3 ml	13 mm	75 mm	
	Sarstedt S-Monovette blood tube	4.0–5.0 ml	15 mm	75 mm	
	Sarstedt V-Monovette urine tube	4.0 ml	13 mm	75 mm	
	BD Vacutainer blood tube	2.0–4.5 ml	13 mm	75 mm	
	BD urine tube	4.0 ml	13 mm	75 mm	
	Greiner VACUETTE tube	2.0–4.0 ml	13 mm	75 mm	
	Open tube	5.0 ml	12 mm	75 mm	
	Blood/Urine tube	4.0–7.0 ml	16 mm	75 mm	
Generic tube <sup>2</sup>	-	17.5 mm	77–90 mm		

<sup>1</sup> Maximum weight at 30 g. For more weight than this reduce the speed according to the formula stated in [„Maximum Loading“ on page 33.](#)

<sup>2</sup> Any tube types which match the dimension stated in table.

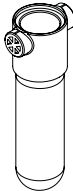
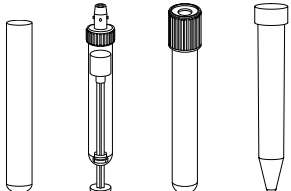
## Swing Out Bucket

Swing Out Bucket				
	Direct Fit (no spacer necessary)			
				
Tube Type	Volume	Diameter	Length	
Sarstedt S-Monovette blood tube	4.5–5.0 ml	11 mm	92 mm	
Sarstedt S-Monovette blood tube	4.9 ml	13 mm	90 mm	
Sarstedt S-Monovette blood tube	7.5–8.2 ml	15 mm	92 mm	
Sarstedt S-Monovette blood tube	9.0–10.0 ml	16 mm	92 mm	
Sarstedt V-Monovette urine tube (round base)	6.0 ml	13 mm	100 mm	
Sarstedt V-Monovette urine tube (conical base)	9.5 ml	15 mm	100 mm	
Sarstedt V-Monovette urine tube (round base)	10.0 ml	15 mm	100 mm	
BD Vacutainer blood tube	3.5–7.0 ml	13 mm	100 mm	
BD Vacutainer blood tube	7.5–10.0 ml	16 mm	100 mm	
BD CPT tube	4.0 ml	13 mm	100 mm	
BD urine tube	8.0 ml	16 mm	100 mm	
Greiner VACUETTE tube	5.0–6.0 ml	13 mm	100 mm	
Greiner VACUETTE tube	8.0–9.0 ml	16 mm	100 mm	
Glass tubes (DIN)	7.0 ml	12 mm	100 mm	
Glass tubes (DIN)	15.0 ml	16 mm	100 mm	
Glass tubes	10.0 ml	16 mm	100 mm	
Open tube	15.0 ml	17 mm	100 mm	
Generic tube <sup>2</sup>	-	17 mm	95–110 mm	

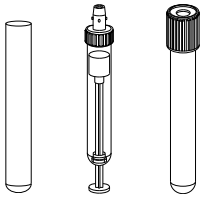
Swing Out Bucket					
	Green Spacer				
					
Tube Type	Volume	Diameter	Length		
Sarstedt S-Monovette blood tube	1.2–1.4 ml	8 mm	66 mm		
Sarstedt S-Monovette blood tube	2.6–4.3 ml	13 mm	65 mm		
Sarstedt S-Monovette blood tube	2.7–3.0 ml	11 mm	66 mm		
Sarstedt S-Monovette blood tube	2.7–4.3 ml	13 mm	75 mm		
Sarstedt S-Monovette blood tube	4.0–5.0 ml	15 mm	75 mm		
Sarstedt V-Monovette urine tube	4.0 ml	13 mm	75 mm		
BD Vacutainer blood tube	2.0–4.5 ml	13 mm	75 mm		
BD urine tube	4.0 ml	13 mm	75 mm		
Greiner VACUETTE tube	2.0–4.0 ml	13 mm	75 mm		
Open tube	5.0 ml	12 mm	75 mm		
Blood/Urine tube	4.0–7.0 ml	16 mm	75 mm		
Generic tube <sup>2</sup>	-	17 mm	77–85 mm		

<sup>2</sup> Any tube types which match the dimension stated in table.

## Checking the Rotor Lifetime

**NOTICE** The cycle counter is counting the centrifuge runs. The cycle counter can not detect changed or replaced rotors and buckets.

The lifetime of rotor and buckets depends on the amount of physical load. Do not exceed the number of cycles recommended for rotor and buckets.

The maximum number of cycles is given in the table stating the rotor specifications. ([Thermo Scientific DualSpin Rotor](#) on page 13)

The maximum number of cycles for buckets is marked on the buckets themselves.

You can check the number of cycles on the centrifuge display. When switching on the centrifuge hold the STOP key pressed. After software version and NVRAM version the actual number of cycles is shown.



When this screen shows the counted cycles will be shown in a few seconds.

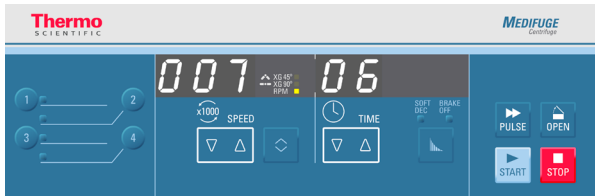

This screen shows the actual cycle numbers. The shown example states 706 cycles.

## Service Life Example

Usage profile	Maximum service life at 60 000 cycles
Frequent use: 23 runs / day, 220 days / year	5 years

## 6. Close the Centrifuge Door



### CAUTION

Do not operate the centrifuge without rubber gasket in the rotor chamber.

Spillage can occur if the centrifuge is operated without rubber gasket.

A hazardous situation caused by biological or chemical substances can occur.

### NOTICE

If the centrifuge door is closed and the display shows "OPEN", the centrifuge is not ready to be operated.

Press the OPEN key and lift the centrifuge door manually. Then close the centrifuge door. The centrifuge should now show the actual operating values.

If not, contact the customer service.

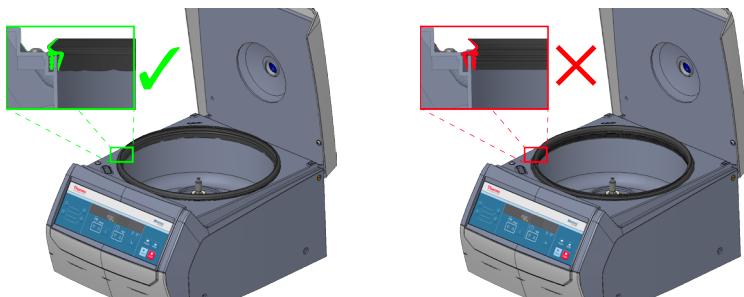

Make sure that the rubber gasket of the rotor chamber is in position.

Close the centrifuge door by pressing down on it lightly.

One lock closes the centrifuge door completely. The door should audibly click into place.

**NOTICE** Do not slam the centrifuge door.

## 7. Centrifugation



### CAUTION

If scraping noises occur, press the STOP key to shut down the centrifuge. Pull out the power supply plug or disconnect the power supply in an emergency.

Replace damaged buckets before the next run.

### NOTICE

If a bang occurs and the centrifuge starts to shake, a bucket can be dropped out of its position due to being installed incorrectly.

Press the STOP key to shut down the centrifuge.

Make sure that the bucket is not damaged before using it again. Install it correctly if it can be used.

### Before a Run

1. Read and observe the precautions and the safety instructions in this instruction manual.
2. Check the rotor and all accessories for damages such as cracks or scratches.
3. Check the rotor chamber and the centrifuge spindle.
4. Check the rotor suitability. „[Chemical Compatibility Chart](#)“ on page 55
5. Make sure that the buckets are in correct position.

Set the parameters for the centrifugation. For details: „[Control Panel Settings](#)“ on page 22

### Starting the Centrifugation

Check the set parameters for the centrifugation, especially when programs are used.

Press the START key. The centrifuge accelerates to the pre-set speed with the time display active.

An animation of a circle is shown while the rotor is spinning.

## Stopping the Centrifugation

When a centrifugation run is finished and the centrifuge shows “END”, this indicates that the selected parameters were reached.

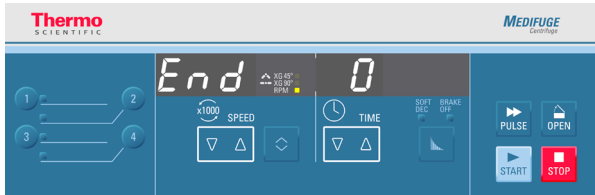

## With Set Time

If the time is set, the centrifuge will run at the selected speed until the set time is reached. It will then automatically decelerate, stop and beep.

Press the OPEN key to open the centrifuge door.

Press the STOP key to manually stop during the centrifugation.

## Continuous Operation

If you selected continuous operation ([„Continuous Operation“ on page 24](#)), you will have to stop the centrifugation manually by pressing the STOP key.

The centrifuge will decelerate at the set rate and beep, when the rotor has stopped.

Press the OPEN key to open the centrifuge door.

## 8. Removing the Rotor

Turn the rotor locking nut counterclockwise (the opposite direction as marked on the rotor locking nut). Remove the rotor from the motor shaft.

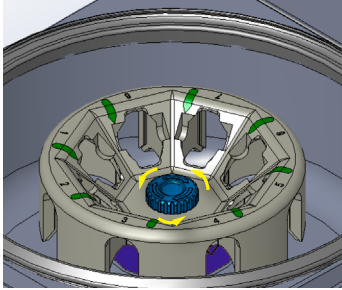

## 9. Switch off the Centrifuge

To switch off the centrifuge push the mains switch to "0".



## V. Maintenance and Care



### CAUTION

Do not use a rotor or accessories with signs of damage.  
 Make sure that rotor, buckets and accessories are within their service lifetime (age and cycles).  
 It is recommended to check rotors and accessories within a yearly routine inspection to ensure safety.



### CAUTION

Do not autoclave the rotor and accessories.  
 Temperatures above 40 °C can damage the material of the rotor and the accessories.

### 1. Cleaning Intervals

For the sake of personal, environmental, and material protection, it is your duty to clean and if necessary disinfect the centrifuge on a regular basis.

Maintenance	Recommended Interval
Rotor chamber (bowl)	Daily or when polluted
Rotor	Daily or when polluted
Accessories	Daily or when polluted
Cabinet	Once per month

## 2. Basics



### CAUTION

Not rated procedures or agents could deteriorate the materials of the centrifuge and lead to malfunction.

Refrain from using any other cleaning or decontamination procedure than those recommended here, if you are not entirely sure that the intended procedure is safe for the equipment.

Use only approved cleansers.

If in doubt, contact the manufacturer of the cleaning agent.

### NOTICE

When you clean the rotor put the rotor locking nut on the thread of the motor shaft and tighten it lightly counterclockwise.

- Use warm water with a neutral detergent that is suitable for use with the materials. If in doubt contact the manufacturer of the cleaning agents.
- Never use caustic cleaning agents such as soap suds, phosphoric acid, bleaching solutions or scrubbing powder.
- Remove rotor and clean bowl with a small amount of cleaning agent, applied to a clean cloth.
- Use a soft brush without metal bristles to remove stubborn residue.  
Afterwards rinse with a small amount of distilled water and remove any excess with absorbent towels.
- Use only disinfectants with a pH of 6-8.

After thoroughly cleaning rotor and accessories, they should be inspected for damage and wear.

### Plastic Parts

Check for signs of plastic crazing, fading, bruising or cracking.



### CAUTION

Do not run any rotor or accessories with sign of damage.

Ensure that the rotor and accessories are within the service life and number of cycles.

It is recommend that you have rotors and accessories inspected yearly as part of your routine service to ensure safety.

### 3. Cleaning



#### CAUTION

Do not autoclave the rotor or accessories.

Do not clean the rotor or accessories in a dishwasher.

Temperatures above 40 °C can damage the material.



#### CAUTION

Before using any cleaning methods except those recommended by the manufacturer, users should check with the manufacturer of the cleaning agents that the proposed method will not damage the equipment.



#### CAUTION

Drive and door lock can be damaged by entering liquids. Do not allow liquids, especially organic solvents, to get on the drive shaft, the drive bearings or the centrifuge door locks.

Organic solvents break down the grease in the motor bearing. The drive shaft could lock up.

Clean as follows:

1. Clean rotor and accessories outside of the centrifuge bowl.
  2. Separate rotor and accessories to allow thorough cleaning.
  3. Rinse rotor and accessories with warm water and a neutral detergent that is suitable for use with the materials. If in doubt contact the manufacturer of the cleaning agents.
  4. Use a soft brush without metal bristles to remove stubborn residue.
  5. Rinse rotor and accessories with distilled water.
  6. Place the rotor and buckets on a plastic grate with cavities pointing down, to allow fully drain and dry.
  7. Dry rotor and accessories after cleaning with a cloth or in a warm air cabinet at a maximum temperature of 40 °C. If drying boxes are used, the temperature must never exceed 40 °C, since higher temperatures could damage the material and shorten the lifetime of the parts.
- Once clean and dry, inspect rotor and accessories.

## 4. Disinfection



### WARNING

Hazardous infection is possible when touching the contaminated rotor and centrifuge parts. Infectious material can get into the centrifuge when a tube breaks or as a result of spills.

In case of contamination, make sure that others are not put at risk. Disinfect the affected parts immediately.



### CAUTION

Equipment can be damaged by inappropriate disinfection methods or agents.

Before using any cleaning or disinfection methods except those recommended by the manufacturer, users should check with the manufacturer that the proposed method will not damage the equipment.

Observe the safety precautions and handling instructions for the cleaning agents used.

The rotor chamber and the rotor should be treated preferably with a neutral disinfectant.

Contact the Service Department of Thermo Fisher Scientific for questions regarding the use of other disinfectants. For details check [“Basics” on page 46](#).

Disinfect as follows:

1. Disinfect rotor and accessories outside of the centrifuge bowl.
2. Separate rotor and accessories to allow thorough disinfection.
3. Treat rotor and accessories according to the instructions for the disinfectant. Adhere strictly to the given application times.  
Be sure the disinfectant can drain off the rotor.
4. Rinse rotor and accessories thoroughly with water and then rub down.
5. Place the rotor on a plastic grate with his cavities pointing down, to allow fully drain and dry.
6. Dispose the disinfectant according to the applicable guidelines.
7. Clean the rotor after disinfecting as described in [“Cleaning” on page 47](#).

## 5. Decontamination



### WARNING

Radiation is possible when touching the contaminated rotor and centrifuge parts. Radioactive material can get into the centrifuge when a tube breaks or as a result of spills.

In case of contamination, make sure that others are not put at risk. Decontaminate the affected parts immediately.



### CAUTION

Equipment can be damaged by inappropriate decontamination methods or agents.

Before using any cleaning or decontamination methods except those recommended by the manufacturer, users should check with the manufacturer that the proposed method will not damage the equipment.

Observe the safety precautions and handling instructions for the cleaning agents used.

For general radioactive decontamination use a solution of equal parts of 70% ethanol, 10% SDS (Sodium Dodecyl Sulfate) and water.

Decontaminate as follows:

1. Decontaminate rotor and accessories outside of the centrifuge bowl.
2. Separate rotor and accessories to allow thorough decontamination.
3. Treat rotor and accessories according to the instructions for the decontamination solution. Adhere strictly to the given application times.  
Be sure the decontamination solution can drain off the rotor.
4. Rinse the rotor first with ethanol and then with deionized water.  
Adhere strictly to the given application times.
5. Be sure the decontamination solution can drain off the rotor.  
Rinse the rotor and accessories thoroughly with water.
6. Place the rotor on a plastic grate with his cavities pointing down, to allow fully drain and dry.
7. Dispose of the decontamination solution according to the applicable guidelines.
8. Clean the rotor after disinfecting as described in ["Cleaning"](#) on page 47.

## 6. Service of Thermo Fisher Scientific

Thermo Fisher Scientific recommends having the centrifuge and accessories serviced once a year by an authorized service technician. The service technician checks the following

- electrical equipment
- suitability of set-up site
- centrifuge door lock and safety system
- rotor
- fixation of rotor and centrifuge spindle
- protective casing

Before service, centrifuge and rotors should be thoroughly cleaned and decontaminated to ensure full and safe inspection can be completed.

Thermo Fisher Scientific offers inspection and service contracts for this work. Any necessary repairs are performed for free during the warranty period and afterwards for a charge.

This is only valid if the centrifuge has only been maintained by an authorized Thermo Fisher Scientific service technician.

## 7. Shipping and Disposal



### WARNING

When removing the centrifuge and accessories from use for disposal you have to clean and additionally disinfect or decontaminate the entire system if biological or chemical substances were used. In doubt contact the Thermo Fisher Scientific customer service.

For the disposal of the centrifuge mind the regulations in your country. Contact the Thermo Fisher Scientific Customer Service for the disposal of the centrifuge. For contact information check the backpage of this manual or visit [www.thermoscientific.com/centrifuge](http://www.thermoscientific.com/centrifuge)

For the countries of the European Union the disposal is regulated by the European Union's Waste Electrical & Electronic Equipment (WEEE) Directive 2002/96/EC.

Mind the information on transport and shipping ("Transport and Set Up" on page 17, "Shipping" on page 20).

## VI. Troubleshooting

### 1. Mechanical Emergency Door Release



#### CAUTION

A spinning rotor can cause serious injuries when touched. In case of power outage the rotor can still be spinning.

Wait 5 minutes to be sure that the rotor can stop spinning.

Do not open the centrifuge before the rotor has stopped. Do not touch the spinning rotor. Do not brake the rotor using hands or other tools.

During a power failure, you will not be able to open the centrifuge door with the regular electric door release. A mechanical override is provided to allow sample recovery in the case of an emergency. This is only to be used in emergencies and after the rotor has come to a complete stop. Always wait until the rotor has come to a stop without braking. The brake does not work when there is no current. The braking process lasts much longer than usual. Wait 10 minutes to be sure that the rotor can stop spinning.

Proceed as follows:

1. Make sure the rotor has stopped (view port in the centrifuge door).
2. Pull out the power supply plug. Keep the centrifuge horizontal at all times.
3. Push the hex key (50149182) straight down through the hole in the centrifuge door until the locking mechanism releases it.

Remove the hex key and open the centrifuge door.

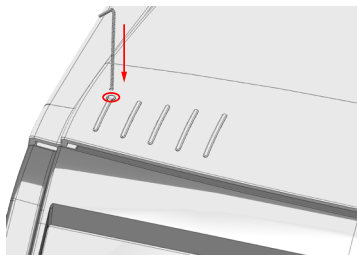

Reconnect the centrifuge to the power supply. Switch on the centrifuge.



## 2. Troubleshooting by Guide

### NOTICE

If problems occur not stated here, customer service must be contacted.

For error numbers shown that are not described in detail in the table, follow this procedure:

1. Restart the centrifuge.
2. If the error message shows again, contact the customer service.

Error number	Description	Troubleshooting
E-24	Centrifuge door cannot be opened	<p>Check, if the centrifuge door is closed correctly.</p> <p>Restart the centrifuge.</p> <p>If the error message shows again, contact the customer service.</p>
E-29	Drive not starting	<p>Make sure that no objects are within the rotor chamber.</p> <p>Make sure that the motor can spin by turning the drive with your hands.</p> <p>Restart the centrifuge.</p> <p>If the error message shows again, contact the customer service.</p>
E-31	Drive temperature high	<p>CAUTION</p> <p>Hot metal parts!</p> <p>Check, if the centrifuge is accessible.</p> <p>Be sure, that the room temperature is within the limits.</p> <p>Remove the rotor.</p> <p>Let the centrifuge cool down for 30 minutes.</p> <p>If the error message shows again, contact the customer service.</p>

Error number	Description	Troubleshooting
E-40	Acceleration is too low	<p>Make sure that the rotor is correctly loaded and balanced.</p> <p>Make sure that no objects are within the rotor chamber.</p> <p>Make sure that the correct the mains connection is correct.</p> <p>Restart the centrifuge.</p> <p>If the error message shows again, contact the customer service.</p>

### 3. When to contact Customer Service

If you need to contact the customer service, please provide the order no. and the serial no. of your centrifuge. This information can be found on the nameplate.

In addition the customer service also needs the software ID and the NVRAM ID. Both are shown by holding the STOP key pressed when switching on the centrifuge.

# Chemical Compatibility Chart

MATERIAL		Chemical Compatibility Chart																												
		CHEMICAL	ALUMINUM	ANODIC COATINGS FOR ALUMINUM	BUNA N	CELLULOSE ACETATE BUTYRATE	POLYURETHANE ROTOR PAINT	COMPOSITE CARBON FIBER/EPOXY	DELRIN™	ETHYLENE PROPYLENE	GLASS	NEOPRENE	NORL™	NYLON	PET, POLYCLEAR™, CLEAR CHAMP™	POLYMER	POLYCARBONATE	POLYESTER, GLASS FIBER/ROSET	POLYIMIDE	POLYETHYLENE	POLYPROPYLENE	POLYSULFONE	POLYVINYL CHLORIDE	RULON A™, TEFLON™	SILICONE RUBBER	STAINLESS STEEL	TITANIUM	TYGON™	VITON™	
	2-MERCAPTOETHANOL	S	S	S	U	/	S	M	S	/	S	U	S	U	U	S	S	/	S	S	S	U	U	S	S	S	S	S	S	S
	ACETALDEHYDE	S	/	/	U	/	/	/	M	/	/	U	/	/	/	M	U	U	U	M	S	U	U	S	U	/	S	/	S	S
	ACETONE	M	S	U	U	U	U	U	S	S	U	U	U	U	U	S	U	U	U	S	S	S	U	S	M	S	U	U	U	U
	ACETONITRILE	S	S	U	U	/	S	M	S	/	S	U	U	U	U	M	U	U	/	S	S	U	U	S	S	S	U	U	U	U
	ALCONOX™	U	U	S	/	S	S	S	S	/	S	S	S	S	S	S	M	S	S	S	S	S	S	S	S	S	S	S	S	S
	ALYL ALCOHOL	/	/	/	U	U	/	/	S	/	/	/	/	/	/	S	S	M	S	S	S	S	M	S	/	/	/	/	/	/
	ALUMINUM CHLORIDE	U	U	S	S	S	S	S	U	S	S	S	S	M	S	S	S	S	/	S	S	S	S	S	U	U	S	S	S	S
	FORMIC ACID (100%)	/	S	U	U	/	/	/	U	/	/	/	/	U	/	S	M	U	U	S	S	/	U	S	/	U	S	S	S	S
	AMMONIUM ACETATE	S	S	U	/	S	S	S	S	/	S	S	S	S	S	S	S	U	/	S	S	S	S	S	S	S	S	S	S	S
	AMMONIUM CARBONATE	M	S	U	S	S	S	S	S	S	S	S	S	S	S	S	U	U	/	S	S	S	S	S	S	M	S	S	S	S

Chemical Compatibility Chart		MATERIAL	
		CHEMICAL	
Aluminum	Aluminum	U	S
Anodic Coating for Aluminum	Buna N	U	S
Cellulose Acetate Butyrate	Polyethylene Rotor Paint	U	S
Composite Carbon Fiber/Epoxy	Delrin™	S	M
Ethylene Propylene	Glass	S	S
Neoprene	Norlon™	S	S
Nylon	Nylon	S	S
PET, Polyclear™, Clear Chimp™	Polyallomer	U	S
Polycarbonate	Polyester, Glass Thermoset	U	M
Polyamide	Polyethylene	S	S
Polypropylene	Polyurethane	S	S
Polystyrene	Polyvinyl Chloride	S	S
Rulon A™, Teflon™	Silicone Rubber	S	S
Stainless Steel	Titanium	S	S
Targon™	Targon™	M	S
Viton™	Viton™	S	S
Ammonium Hydroxide (10%)	Aluminum	U	S
Ammonium Hydroxide (28%)	Buna N	U	S
Ammonium Hydroxide (conc.)	Cellulose Acetate Butyrate	U	S
Ammonium Phosphate	Composite Carbon Fiber/Epoxy	U	S
Ammonium Sulfate	Delrin™	U	S
Amyl Alcohol	Ethylene Propylene	S	/
Aniline	Glass	S	S
Sodium Hydroxide (<1%)	Nylon	U	U
Sodium Hydroxide (10%)	Norlon™	U	U
Barium Salts	Neoprene	M	U
Benzene	PET, Polyclear™, Clear Chimp™	S	U
Benzyl Alcohol	Polyallomer	S	U

MATERIAL		Chemical Compatibility Chart																												
		CHEMICAL	ALUMINUM	ANODIC COATING FOR ALUMINUM	BUVA N	CELLULOSE ACETATE BUTYRATE	POLYURETHANE ROTOR PAINT	COMPOSITE CARBON FIBER/EPOXY	DELTA™	ETHYLENE PROPYLENE	GLASS	NEOPRENE	NORL™	NYLON	PET, POLYCLEAR™, CLEAR CHIMP™	POLYMER	POLYCARBONATE	POLYESTER, GLASS FIBER/THERMOSET	POLYURETHANIDE	POLYETHYLENE	POLYPROPYLENE	POLYSTYRENE	POLYVINYL CHLORIDE	RULON A™, TEFLON™	SILICONE RUBBER	STAINLESS STEEL	TITANIUM	TRIGON™	VIRON™	
Boric Acid	U	S	S	M	S	S	S	U	S	S	S	S	S	S	S	S	S	S	U	S	S	S	S	S	S	S	S	S	S	
Cesium Acetate	M	/	S	/	S	S	S	S	/	S	S	S	/	/	S	S	S	/	/	S	S	S	S	S	M	M	S	S	S	
Cesium Bromide	M	S	S	/	S	S	S	S	/	S	S	S	S	S	S	S	S	/	/	S	S	S	S	S	S	S	S	S	S	
Cesium Chloride	M	S	S	U	S	S	S	S	/	S	S	S	S	S	S	S	S	/	/	S	S	S	S	S	S	S	S	S	S	
Cesium Formate	M	S	S	/	S	S	S	S	/	S	S	S	S	S	S	S	S	/	/	S	S	S	S	S	M	M	S	S	S	
Cesium Iodide	M	S	S	/	S	S	S	S	/	S	S	S	S	S	S	S	S	/	/	S	S	S	S	S	M	M	S	S	S	
Cesium Sulfate	M	S	S	/	S	S	S	S	/	S	S	S	S	S	S	S	S	/	/	S	S	S	S	S	M	M	S	S	S	
Chloroform	U	U	U	U	U	S	S	M	U	S	U	U	M	U	M	U	U	U	U	M	M	U	U	U	U	U	M	S	S	S
Chromic Acid (10%)	U	/	U	U	U	U	U	U	/	S	S	S	U	S	S	M	U	U	M	S	S	U	M	S	M	S	/	S	S	S
Chromic Acid (50%)	U	/	U	U	U	U	U	U	/	/	/	/	U	U	U	M	M	U	M	S	S	U	M	S	/	M	/	S	S	S
Cresol Mixture	S	S	U	/	/	/	/	S	/	S	U	U	U	U	U	U	U	/	/	U	U	/	U	S	S	S	U	S	S	S
Cyclohexane	S	S	S	/	/	/	/	S	U	S	U	U	S	U	U	U	U	M	S	M	U	U	M	S	U	M	U	S	S	S



CHEMICAL		MATERIAL																										
		ALUMINUM	ANODIC COATING FOR ALUMINUM	BUVA N	CELLULOSE ACETATE BUTYRATE	POLYURETHANE ROTOR PAINT	COMPOSITE CARBON FIBER/EPOXY	DELTA™	ETHYLENE PROPYLENE	GLASS	NEOPRENE	NORL™	NYLON	PET, POLYCLEAR™, CLEAR CHIMP™	POLYMER	POLYCARBONATE	POLYESTER, GLASS FIBER, THERMOSET	POLYIMIDE	POLYETHYLENE	POLYPROPYLENE	POLYSTYRENE	POLYVINYL CHLORIDE	RULON A™, TEFLON™	SILICONE RUBBER	STAINLESS STEEL	TITANIUM	TRIGON™	VIRON™
ETHYL ACETATE		M	M	U	U	S	M	M	S	S	U	S	U	U	U	U	U	/	S	S	U	U	S	M	S	U	U	U
ETHYL ALCOHOL (50%)		S	S	S	S	S	M	S	S	S	S	S	U	U	U	U	U	S	S	S	S	S	S	M	S	M	U	U
ETHYL ALCOHOL (95%)		S	S	S	U	S	M	S	S	S	S	S	U	U	U	U	U	/	U	S	M	S	S	U	S	M	U	U
ETHYLENE DICHLORIDE		S	/	U	U	/	S	S	/	U	S	S	U	U	U	U	U	U	U	U	/	U	S	U	/	S	/	S
ETHYLENE GLYCOL		S	S	S	S	S	S	S	S	S	S	S	/	U	U	U	U	S	S	S	S	S	S	M	S	M	S	S
ETHYLENE OXIDE VAPOR		S	/	U	/	U	/	/	/	U	U	/	/	/	/	/	/	/	/	/	/	/	/	U	S	S	S	U
FOOL-HYDROQUE™		M	S	S	/	S	S	S	/	S	S	S	/	S	S	S	S	/	S	S	S	S	S	M	S	S	S	S
HYDROFLUORIC ACID (10%)		U	U	U	M	/	U	/	/	U	U	S	/	S	M	U	U	S	S	S	S	S	U	U	U	/	/	/
HYDROFLUORIC ACID (60%)		U	U	U	U	/	U	/	/	U	U	U	U	U	U	U	U	U	S	S	S	M	S	U	U	/	/	M
HYDROCHLORIC ACID (conc.)		U	U	U	U	U	U	M	/	U	U	U	U	U	U	U	U	U	/	S	/	U	S	U	U	/	/	/
FORMALDEHYDE (40%)		M	M	S	S	S	S	S	S	S	S	S	M	S	S	S	S	U	S	S	S	S	S	M	S	M	U	U
GLUTARALDEHYDE		S	S	S	S	/	S	/	S	S	S	S	S	S	S	S	S	/	S	S	S	S	S	S	S	/	/	/

MATERIAL		Chemical Compatibility Chart																										
		ALUMINUM	ALUMINUM ANODIC COATING FOR ALUMINUM	BUNA N	CELLULOSE ACETATE BUTYRATE	POURTHANE ROTOR PAINT	COMPOSITE CARBON FIBER/EPOXY	DELRA™	ETHYLENE PROPYLENE	GLASS	NEOPRENE	NORL™	NYLON	PET, POLYCLEAR™ CLEAR CHIMP™	POLYALLOMER	POLYCARBONATE	POLYESTER, GLASS FIBER/EMOSSET	POLYHERMIDE	POLYETHYLENE	POLYPROPYLENE	POLYSTYRENE	POLYVINYL CHLORIDE	FLUON A™, TEFLON™	SILICONE RUBBER	STAINLESS STEEL	TITANIUM	TRIGON™	VITON™
CHEMICAL	GLYCEROL	M	S	S	/	S	S	S	S	S	S	S	S	S	S	S	S	/	S	S	S	S	S	S	S	S	S	S
	GUANIDINE HYDROCHLORIDE	U	U	S	/	S	S	/	S	S	S	S	S	S	S	S	/	S	S	S	S	S	S	U	S	S	S	S
	HEMO-SOL™	S	S	S	/	/	S	/	S	S	S	S	S	S	S	S	/	S	S	S	S	S	S	S	S	S	S	S
	HEXANE	S	S	S	/	S	S	/	S	S	U	S	S	U	M	U	S	S	U	S	S	S	S	U	S	S	S	S
	ISOBUTYL ALCOHOL	/	/	M	U	/	S	/	S	U	/	S	U	U	S	S	M	S	S	S	S	S	S	/	S	/	S	S
	ISOPROPYL ALCOHOL	M	M	M	U	S	S	S	S	U	S	S	U	U	S	U	M	S	S	S	S	S	S	M	M	M	M	M
	IODOACETIC ACID	S	S	M	/	S	/	S	/	U	S	S	S	M	S	S	/	M	S	S	S	S	S	M	S	M	M	M
	POTASSIUM BROMIDE	U	S	S	/	S	/	S	/	S	S	S	S	S	S	S	S	S	S	S	S	S	S	M	S	S	S	S
	POTASSIUM CARBONATE	M	U	S	S	S	/	S	/	S	S	S	S	S	S	U	S	S	S	S	S	S	S	S	S	S	S	S
	POTASSIUM CHLORIDE	U	S	S	/	S	/	S	S	S	S	S	S	S	S	S	/	S	S	S	S	S	S	S	S	S	S	S
	POTASSIUM HYDROXIDE (5%)	U	U	S	S	S	/	S	/	S	S	S	/	S	S	U	S	S	S	S	S	S	S	U	M	S	S	U
	POTASSIUM HYDROXIDE (CONC.)	U	U	M	U	/	/	/	M	S	S	/	/	U	M	U	U	U	U	S	S	S	U	/	U	/	U	U





MATERIAL		Chemical Compatibility Chart																										
		CHEMICAL	ALUMINUM	ANODIC COATING FOR ALUMINUM	BUNA N	CELLULOSE ACETATE BUTYRATE	POLYURETHANE ROTOR PAINT	COMPOSITE CARBON FIBER/EPOXY	DELTA™	ETHYLENE PROPYLENE	GLASS	NEOPRENE	NORL™	NYLON	PET, POLYCLEAR™, CLEAR CHIMP™	POLYMER	POLYCARBONATE	POLYESTER, GLASS FIBER/EPoxy	POLYURETHANE	POLYETHYLENE	POLYPROPYLENE	POLYSTYRENE	POLYVINYL CHLORIDE	RULON A™, TEFLON™	SILICONE RUBBER	STAINLESS STEEL	TITANIUM	TYGON™
METHYLENE CHLORIDE	U	U	U	U	U	M	S	S	U	S	U	U	S	U	U	U	U	U	M	U	U	U	U	S	M	U	S	U
METHYL ETHYL KETONE	S	S	U	U	U	S	S	M	S	S	U	U	S	U	U	U	U	U	S	S	S	U	S	S	S	S	U	U
METHANOL	M	S	S	S	/	S	S	S	/	S	S	/	S	/	S	S	S	/	/	S	S	S	S	S	S	S	S	S
LACTIC ACID (100%)	/	/	S	/	/	/	/	/	/	/	M	S	U	/	S	S	S	/	S	S	S	/	S	S	S	/	S	S
LACTIC ACID (20%)	/	/	S	/	/	/	/	/	/	/	M	S	U	/	S	S	S	/	S	S	S	/	S	S	S	/	S	S
N-BUTYL ALCOHOL	S	/	S	U	U	/	/	/	/	/	S	M	/	U	S	M	S	S	S	S	S	M	S	/	M	/	S	S
N-BUTYL PHTHALATE	S	S	U	/	U	S	S	S	/	S	U	U	S	U	U	U	U	M	/	U	U	S	U	S	M	S	U	S
N,N-DIMETHYLFORMAMIDE	S	S	U	U	U	S	M	S	/	S	S	U	S	U	U	U	U	U	/	S	S	U	S	M	S	S	U	S
SODIUM BORATE	M	S	S	S	S	S	S	S	S	S	S	S	U	S	S	S	S	S	/	S	S	S	S	M	S	S	S	S
SODIUM BROMIDE	U	S	S	/	U	S	S	S	/	S	S	S	S	S	S	S	S	S	/	S	S	S	S	S	M	S	S	S
SODIUM CARBONATE (2%)	M	U	S	S	S	S	S	S	S	S	S	S	S	S	S	S	S	S	S	S	S	S	S	S	S	S	S	S
SODIUM DIOCEYL SULFATE	S	S	S	/	U	S	S	S	/	S	S	S	S	S	S	S	S	S	/	S	S	S	S	S	S	S	S	S



MATERIAL		Chemical Compatibility Chart																										
		ALUMINUM	ANODIC COATING FOR ALUMINUM	BUVA N	CELLULOSE ACETATE BUTYRATE	POLYURETHANE ROTOR PAINT	COMPOSITE CARBON FIBER/EPOXY	DELTA™	ETHYLENE PROPYLENE	GLASS	NEOPRENE	NORL™	NYLON	PET, POLYCLEAR™, CLEAR CHIMP™	POLYALOMER	POLYCARBONATE	POLYESTER, GLASS THERMOSET	POLYURETHANIDE	POLYETHYLENE	POLYPROPYLENE	POLYSTYRENE	POLYVINYL CHLORIDE	RULON A™, TEFLON™	SILICONE RUBBER	STAINLESS STEEL	TITANIUM	TRIGON™	VIRON™
PERCHLORIC ACID (70%)		U	U	U	/	/	U	/	S	U	M	U	U	U	U	U	U	U	M	M	U	M	S	U	S	S	S	S
PHENOL (5%)		U	S	U	/	S	M	/	S	U	M	U	U	U	U	U	M	S	M	S	U	U	U	U	M	M	S	
PHENOL (50%)		U	S	U	/	S	U	/	S	U	M	U	U	U	U	U	U	U	M	S	U	U	U	U	U	M	S	
PHOSPHORIC ACID (10%)		U	U	M	S	S	S	U	S	S	S	U	/	S	S	S	S	S	S	S	S	S	S	U	U	S	S	
PHOSPHORIC ACID (CONC.)		U	U	M	M	/	/	U	/	M	S	U	U	M	S	M	S	S	M	S	S	M	S	U	U	/	S	
PHOSPHORIC MEX (SERUM, URIC)		M	S	S	S	/	/	S	/	S	S	S	S	S	S	S	S	S	S	S	S	S	S	S	S	S	S	
PICRIC ACID		S	S	U	/	S	M	S	S	M	S	U	U	S	S	S	U	U	S	S	S	U	U	U	S	M	S	
PYRIDINE (50%)		U	S	U	U	S	U	/	U	S	S	U	U	M	U	U	U	/	U	S	S	U	S	U	U	U	U	
RUBIDIUM BROMIDE		M	S	S	/	S	S	/	S	S	S	S	S	S	S	S	/	/	S	S	S	S	S	M	S	S	S	
RUBIDIUM CHLORIDE		M	S	S	/	S	S	/	S	S	S	S	S	S	S	S	/	/	S	S	S	S	S	M	S	S	S	
SUCROSE		M	S	S	/	S	S	S	S	S	S	S	S	S	S	S	S	S	S	S	S	S	S	S	S	S	S	
SUCROSE, ALKALINE		M	S	S	/	S	S	/	S	S	S	S	S	S	S	S	S	S	S	S	S	S	S	M	S	S	S	

MATERIAL		Chemical Compatibility Chart																										
		ALUMINUM	ANODIC COATING FOR ALUMINUM	BUVA N	CELLULOSE ACETATE BUTYRATE	POLYURETHANE ROTOR PAINT	COMPOSITE CARBON FIBER/EPOXY	DELTA™	ETHYLENE PROPYLENE	GLASS	NEOPRENE	NORL™	NYLON	PET, POLYCLEAR™, CLEAR CHIMP™	POLYALOMER	POLYCARBONATE	POLYESTER, GLASS THERMOSET	POLYURETHANIDE	POLYETHYLENE	POLYPROPYLENE	POLYSTYRENE	POLYVINYL CHLORIDE	RULON A™, TEFLON™	SILICONE RUBBER	STAINLESS STEEL	TITANIUM	TRIGON™	VRON™
SULFOSALICYLIC ACID	U	U	U	U	S	S	S	/	S	S	S	U	S	S	S	/	S	S	S	S	S	S	S	S	S	S	S	S
NITRIC ACID (10%)	U	S	U	S	S	U	U	/	S	U	S	U	/	S	S	S	S	S	S	S	S	S	S	S	S	S	S	S
NITRIC ACID (50%)	U	S	U	M	S	U	U	/	S	U	S	U	U	M	M	U	U	M	M	M	U	S	U	S	S	M	S	S
NITRIC ACID (95%)	U	/	U	U	U	U	U	/	/	U	U	U	U	M	U	U	U	U	U	M	U	S	U	S	S	/	S	S
HYDROCHLORIC ACID (10%)	U	U	M	S	S	S	U	/	S	S	S	U	U	S	U	U	S	S	S	S	S	S	S	U	M	S	S	S
HYDROCHLORIC ACID (60%)	U	U	U	U	U	U	U	/	S	M	S	U	U	M	U	U	U	S	S	S	S	M	U	U	U	M	M	M
SULFURIC ACID (10%)	M	U	U	S	U	U	U	/	S	S	M	U	U	S	S	S	S	S	S	S	S	S	U	U	U	S	S	S
SULFURIC ACID (50%)	M	U	U	U	U	U	U	/	S	S	M	U	U	S	U	U	U	M	S	S	S	S	U	U	U	M	M	S
SULFURIC ACID (CONC.)	M	U	U	U	U	U	U	M	/	/	/	U	U	U	U	U	U	U	S	S	S	M	U	U	U	/	S	S
STEARIC ACID	S	/	S	/	/	/	S	M	S	S	S	S	/	S	S	S	S	S	S	S	S	S	M	M	S	S	S	S
TETRAHYDROFURAN	S	S	U	U	U	U	U	M	S	U	U	S	U	U	U	U	/	M	U	U	U	S	U	S	S	U	U	U
TOLUENE	S	S	U	U	U	S	M	U	S	U	U	S	U	U	U	U	S	U	M	U	U	S	U	S	S	U	U	M

Chemical Compatibility Chart		MATERIAL	
		CHEMICAL	MATERIAL
TRICHLOROACETIC ACID	U	U	Viton™
TRICHLOROETHANE	S	/	Tygon™
TRICHLOROETHYLENE	/	/	TITANIUM
TRISODIUM PHOSPHATE	/	/	STAINLESS STEEL
TRIS BUFFER (NEUTRAL PH)	U	S	SILICONE RUBBER
TRITON X/100™	S	S	Bulon A™, Teflon™
UREA	S	/	POLYVINYL CHLORIDE
HYDROGEN PEROXIDE (10%)	U	M	POLYSULFONE
HYDROGEN PEROXIDE (3%)	S	S	POLYPROPYLENE
XYLENE	S	U	POLYETHYLENE
ZINC CHLORIDE	U	S	POLYETHERIMIDE
ZINC SULFATE	U	S	POLYESTER, GLASS FIBRE/MOSET
		M	POLYCARBONATE
		U	POLYIMMER
		U	PET, POLYCLEAR™ Clear Chimp™
		U	NYLON
		S	NORL™
		U	NEOPRENE
		S	GLASS
		M	ETHYLENE PROPYLENE
		U	DELBIN™
		S	COMPOSITE CARBON FIBRE/EPOXY
		S	POLYURETHANE ROTOR PAINT
		/	CELLULOSE ACETATE BUTYRATE
		U	BUNA N
		/	ANODIC COATING FOR ALUMINIUM
		/	ALUMINIUM

Chemical Compatibility Chart	
CHEMICAL	MATERIAL
Citric Acid (10%)	M
Aluminum	S
Anodic Coating for Aluminum	S
Buna N	S
Cellulose Acetate Butyrate	M
Polyurethane Rotor Paint	S
Composite Carbon Fiber/Epoxy	S
Delrin™	M
Ethylene Propylene	S
Glass	S
Neoprene	S
Noryl™	S
Nylon	S
PET, Polyclear™, Clear Chimp™	S
Polyalomer	S
Polycarbonate	S
Polyester, Glass Thermoset	S
Polyamide	M
Polyethylene	S
Polypropylene	S
Polystyrene	S
Polyvinyl Chloride	S
Rulon A™, Teflon™	S
Silicone Rubber	S
Stainless Steel	S
Titanium	S
Tygon™	S
Viton™	S

† Polyethyleneterephthalate

S – Satisfactory.

M – Moderate attack, may be satisfactory for use in centrifuge depending on length of exposure, speed involved, etc.; suggest testing under actual conditions of use.

U – Unsatisfactory, not recommended.

/ – Performance unknown; suggest testing, using sample to avoid loss of valuable material.

**NOTICE** Chemical resistance data is included only as a guide to product use. Because no organized chemical compatibility data exists for materials under the stress of centrifugation, when in doubt we recommend pretesting sample lots.

# Declaration of Decontamination

## NOTICE

Thermo Fisher Scientific representatives will indicate on a customer service repair report if decontamination was required, and if so, what the contaminate was and what procedure was used. If no decontamination was required, it should be stated so.

Print or copy the page with the decontamination certificate. Then complete and attach it to the equipment before shipping for service.

## Instructions

When an instrument that has been used with radioactive, pathogenic, or otherwise hazardous materials requires servicing by Thermo Fisher Scientific personnel either at the customer's laboratory or at Thermo Fisher Scientific facilities, the following procedure must be complied with to insure safety of our personnel:

1. The instrument or part to be serviced shall be cleaned of all blood and other encrusted material and decontaminated prior to servicing by our representative. No radioactivity shall be detectable by survey equipment.
2. A Decontamination Certificate shall be completed and attached to the instrument or part.

If an instrument or part to be serviced does not have a Decontamination Certificate attached to it, and, in our opinion, presents a potential radioactive or biological hazard, our representative will not service the equipment until proper decontamination and certification has been completed.

If an instrument is received at our Service facilities and, in our opinion, poses a radioactive or biological hazard, the sender will be contacted for instructions as to disposition of the equipment. Disposition costs will be borne by the sender.

Copy or print this Decontamination Certificate. Additional Decontamination Certificates are available from your local technical or customer service representative. In the event these certificates are not available, a written statement certifying that the instrument or part has been properly decontaminated and outlining the procedures used will be acceptable.



**Decontamination Certificate**

DECONTAMINATION

CERTIFIED BY \_\_\_\_\_ TITLE/POSITION \_\_\_\_\_

PHONE \_\_\_\_\_ FAX \_\_\_\_\_

DEPARTMENT \_\_\_\_\_ INSTITUTION \_\_\_\_\_

ADDRESS \_\_\_\_\_ CITY \_\_\_\_\_

STATE \_\_\_\_\_ ZIP \_\_\_\_\_

INSTRUMENT \_\_\_\_\_ SERIAL NUMBER \_\_\_\_\_

ROTOR \_\_\_\_\_ SERIAL NUMBER \_\_\_\_\_

PART \_\_\_\_\_ PART NUMBER \_\_\_\_\_

HAZARDOUS CONTAMINANTS(S) \_\_\_\_\_

DECONTAMINATION DATE \_\_\_\_\_

DECONTAMINATION METHOD(S) \_\_\_\_\_

DECONTAMINATION CERTIFIER'S SIGNATURE \_\_\_\_\_ DATE \_\_\_\_\_

# Acceleration/Deceleration Profiles

The shown diagrams are both based on a fully loaded rotor operated at rated voltage. Your actual operating results may differ to this depending on the operating conditions. Because of that the diagrams are for reference purposes only.

## Fixed Angle

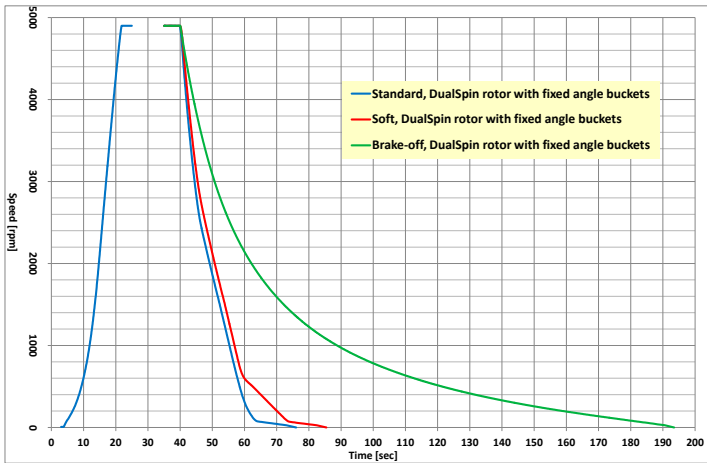

## Swing Out

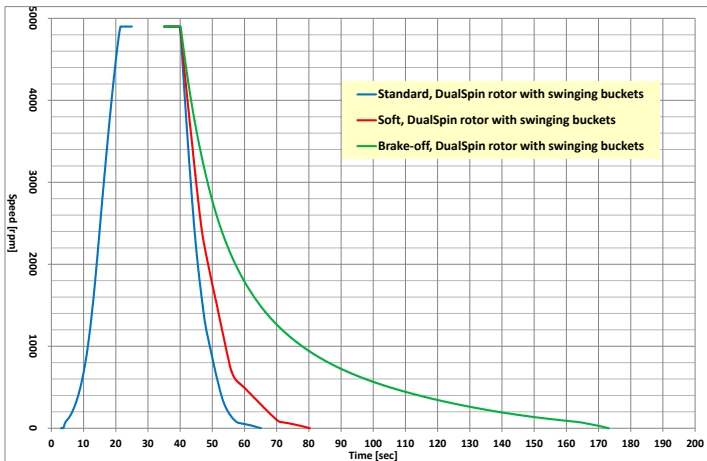

# Index

## A

Acceleration / Deceleration Profiles 25

## B

Before Setting Up 17

## C

Centrifugation 42  
 Chemical Compatibility Chart 55  
 Cleaning 47  
 Cleaning Intervals 45  
 Close the Centrifuge Door 41  
 Control Panel 21  
 Control Panel Settings 22  
 Customer Service 54

## D

Declaration of Decontamination 68  
 Decontamination 49  
 Directives, Standards and Guidelines 15  
 Disinfection 48  
 Disposal 51

## I

Intended Use 5  
 Items Supplied 6

## L

Leveling 18  
 Location 17

## M

Mains Connection 19  
 Mains Supply 16  
 Maintenance and Care 45  
 Maximum Loading 33  
 Mechanical Emergency Door Release 52  
 Mixed Bucket Set Up 33

## O

Open the Centrifuge Door 27  
 Operation 27

## P

Precautions 7  
 Preface 5  
 Programs 25

## R

Removing the Rotor 44  
 Rotor and Accessories 14  
 Rotor Installation 28  
 Rotor Lifetime 39  
 Rotor Loading 31  
 Rotor Temperature Range 31  
 RPM/RCF 22  
 Runtime 24

## S

Service of Thermo Fisher Scientific 50  
 Set Up 17  
 Shipping 20, 51  
 Storage 19  
 Switching on 27  
 Switch off 44  
 Symbols used in the Manual 11  
 Symbols used on the Centrifuge 11

## T

Technical Data 12  
 Technical Specifications 12  
 Transport 17  
 Transporting 18  
 Troubleshooting 52, 53  
 Tube and Spacer Guide 34



**KONFORMITÄTSERKLÄRUNG  
DECLARATION OF CONFORMITY**

Name und Anschrift des Herstellers und des Bevollmächtigten  
für die Zusammenstellung der relevanten technischen Unterlagen:  
*Name and address of the manufacturer and of the authorized  
representative to compile the relevant technical documentation:*

**Thermo Electron LED GmbH  
Zweigniederlassung Osterode  
Am Kalkberg  
37520 Osterode am Harz  
Germany**

**Gegenstand der Erklärung / Object of the declaration:**

<b>Beschreibung / description</b>	: Labor- Zentrifuge mit Zubehör / centrifuge with accessories
<b>Marke / brand</b>	: Thermo Scientific
<b>Modellbezeichnung / model name</b>	: Medifuge
<b>Modell Nr. / model no.</b>	: 75008800
<b>Gültig ab Equipmentnr. Valid from equipment no.</b>	: 41873761

**Der oben beschriebene Gegenstand der Erklärung erfüllt die einschlägigen Bestimmungen der Richtlinie über In-vitro-Diagnostika 98/79/EG.**

*The object of the declaration described above is in conformity with all relevant terms of directive for in vitro diagnostic medical devices 98/79/EC.*

Die Schutzziele der Maschinenrichtlinie 2006/42/EG, der Niederspannungsrichtlinie 2006/95/EG & 2014/35/EU und der Richtlinie über elektromagnetische Verträglichkeit 2004/108/EG werden eingehalten.

*The protection goals for the directives machinery 2006/42/EC, low voltage 2006/95/EC & 2014/35/EU and electromagnetic compatibility 2004/108/EC are met.*

Der oben beschriebene Gegenstand der Erklärung erfüllt auch die Vorschriften der Richtlinie 2011/65/EU des Europäischen Parlaments und des Rates vom 8. Juni 2011 zur Beschränkung der Verwendung bestimmter gefährlicher Stoffe in Elektro- und Elektronikgeräten.

*The object of the declaration described above is also in conformity with Directive 2011/65/EU of the European Parliament and of the Council of 8 June 2011 on the restriction of the use of certain hazardous substances in electrical and electronic equipment.*

Die alleinige Verantwortung für die Ausstellung dieser Konformitätserklärung trägt der Hersteller.

*This declaration of conformity is issued under the sole responsibility of the manufacturer.*

Angewandte harmonisierte Normen/ *Harmonized standards used :*

- EN 61010-1:2013**
- EN 61010-2-020:2006 & CDV 61010-2-020:2015**
- IEC 61010-2-101:2015 (Class B)**
- EN 61326-1:2013 (Class B)**
- EN 61326-2-6:2013**

Unterzeichnet für und im Namen von: Thermo Electron LED GmbH.

*Signed for and on behalf of: Thermo Electron LED GmbH.*

Osterode am Harz, den 10.11.2015

Dr. Andreas Karl  
Director R&D

	Name	Datum	Dokument	Revision
Erstellt	Lenemann	10.11.2015	60150378	00
Freigegeben	Laaboubi	10.11.2015		

50148677-d is the original instruction manual.

## [thermoscientific.com/centrifuge](http://thermoscientific.com/centrifuge)

© 2015 Thermo Fisher Scientific Inc. All rights reserved. All trademarks are the property of Thermo Fisher Scientific Inc. and its subsidiaries unless otherwise specified.

Delrin, TEFLON, and Viton are registered trademarks of DuPont. Noryl is a registered trademark of SABIC. POLYCLEAR is a registered trademark of Hongye CO., Ltd. Hypaque is a registered trademark of Amersham Health As. RULON A and Tygon are registered trademarks of Saint-Gobain Performance Plastics. Alconox is a registered trademark of Alconox. Ficoll is a registered trademark of GE Healthcare. Haemo-Sol is a registered trademark of Haemo-Sol. Triton X-100 is a registered trademark of Sigma-Aldrich Co. LLC. Valox is a registered trademark of General Electric Co. S-MONOVETTE are V-MONOVETTE are registered trademarks of Sarstedt AG & Co. VACUETTE is a registered trademark of Greiner Bio-One International GmbH. BD and Vacutainer are registered trademarks of Becton, Dickinson and Company.

Specifications, terms and pricing are subject to change. Not all products are available in all countries. Please consult your local sales representative for details.

Shown pictures within the manual are examples and may differ considering the set parameters and language.

**Australia** +61 39757 4300

**Austria** +43 1 801 40 0

**Belgium** +32 53 73 42 41

**China** +800 810 5118 or  
+400 650 5118

**France** +33 2 2803 2180

**Germany national toll free** 0800 1 536 376

**Germany international** +49 6184 90 6000

**India** +91 22 6716 2200

**Italy** +39 02 95059 552

**Japan** +81 3 5826 1616

**Netherlands** +31 76 579 55 55

**New Zealand** +64 9 980 6700

**Nordic/Baltic/CIS countries**

+358 10 329 2200

**Russia** +7 812 703 42 15

**Spain/Portugal** +34 93 223 09 18

**Switzerland** +41 44 454 12 12

**UK/Ireland** +44 870 609 9203

**USA/Canada** +1 866 984 3766

**Other Asian Countries** +852 2885 4613

**Countries not listed** +49 6184 90 6000

**Thermo Electron LED GmbH**

Zweigniederlassung Osterode

Am Kalkberg, 37520 Osterode am Harz

Germany

**Thermo**  
S C I E N T I F I C

Part of Thermo Fisher Scientific