

**ROTO SILENTA 630 RS**

Ⓧ DE	<b>Bedienungsanleitung .....</b>	<b>10</b>
Ⓧ EN	<b>Operating Instructions .....</b>	<b>34</b>
Ⓧ FR	<b>Mode d'emploi .....</b>	<b>57</b>
Ⓧ IT	<b>Istruzioni per l'uso .....</b>	<b>81</b>

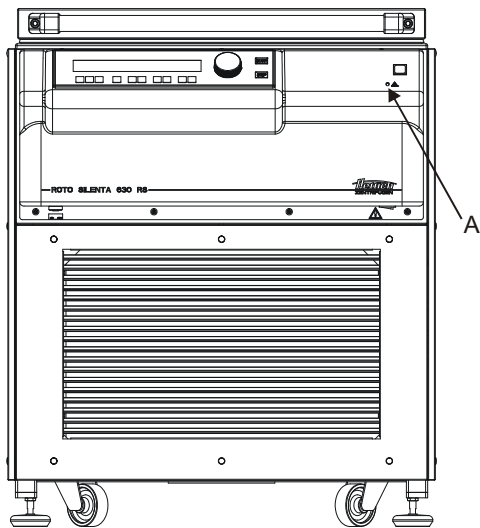

Fig. 1

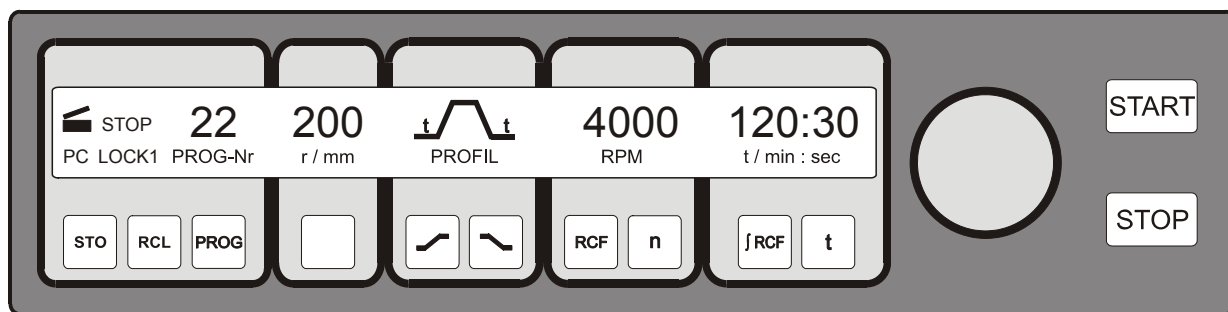

Fig. 2

**EG-Konformitätserklärung**  
**EC Declaration of conformity**  
**Déclaration de conformité CE**  
**Dichiarazione di conformità CE**

des Herstellers / of the manufacturer / du fabricant / del costruttore  
Andreas Hettich GmbH & Co. KG • Föhrenstraße 12 • D-78532 Tuttlingen • Germany

Hiermit erklären wir in alleiniger Verantwortung, dass das bezeichnete Gerät, inklusive dem mit dem Gerät konformitätsbewertetem Zubehör laut Zubehörliste der technischen Dokumentation dieses Geräts, der Richtlinie für Medizinprodukte 93/42/EWG entspricht.

We hereby declare under our sole responsibility that the designated device and its accessories, which are listed in the technical documentation for this device and whose conformity has been assessed together with the device, conform to the Medical Device Directive – Council Directive 93/42/EEC.

Par la présente, nous déclarons sous notre seule responsabilité que l'appareil désigné, incluant ses accessoires attestés conformes d'après la liste des accessoires de la documentation technique du dit-appareil, répond à la directive 93/42/CEE sur les produits médicaux.

Si dichiara nella nostra sola responsabilità, che l'apparecchiatura indicata, comprensiva dei conformi accessori come da elenco della documentazione tecnica di questa apparecchiatura, risponde alle direttive per prodotti medicali 93/42/CEE.

Geräteart / Type of device / Type d'appareil / Tipo di apparecchio:

**Laborzentrifuge / Laboratory centrifuge / Centrifugeuse de laboratoire / Centrifuga di laboratorio**

Typenbezeichnung / Type designation / Désignation du type / Denominazione del tipo:

**ROTO SILENTA 630 RS**

Das Konformitätsbewertungsverfahren wurde nach den Anhängen V und VII der Richtlinie 93/42/EWG unter Mitwirkung der nachfolgenden benannten Stelle durchgeführt:

The conformity evaluation process was performed in accordance with appendices V and VII of Directive 93/42/EEC involving the following notified bodies:

La procédure d'évaluation de la conformité a été réalisée conformément aux annexes V et VII de la directive 93/42/CEE avec le concours de la société désignée ci-après:

La procedura di valutazione di conformità è stata eseguita conformemente alle appendici V e VII delle direttive 93/42/CEE con il concorso dei seguenti collaboratori:

**MEDCERT GmbH – Notified Body CE 0482**

tel: +49 (0)40 - 22633250

fax: +49 (0)40 - 226332515

e-mail: info@medcert.de

website: www.med-cert.com

mail: Pilatuspool 2, D-20355 Hamburg; Germany

**Weitere, mitgeltende europäische Richtlinien:**

- Maschinenrichtlinie 2006/42/EG
- EMV-Richtlinie 2004/108/EG
- Niederspannungsrichtlinie 2006/95/EC
- RoHS II Richtlinie 2011/65/EG (ohne Beteiligung einer benannten Stelle)

Angewandte Normen:

Gemäß Liste der angewandten Normen, die Teil der Produktakte ist.

**Further partly applicable European directives:**

- Machinery Directive 2006/42/EC
- EMC directive 2004/108/EC
- Low voltage directive 2006/95/EC
- RoHS II Directive 2011/65/EC (without involvement of a notified body)

Applied standards:

According to the list of applied standards, which is part of the product file.

**Autres directives européennes partiellement valables :**

- directive 2006/42/EG relative aux machines
- directive CEM 2004/108/EG
- directive basse tension 2006/95/EC
- Directive RoHS II 2011/65/CE (sans participation d'un organisme désigné)

Normes appliquées:

Conformément à la liste des normes appliquées relatives aux cycles du produit.

**Ulteriori direttive europee, che sono in parte di validità:**

- Direttive per macchine 2006/42/CE
- Direttive per compatibilità elettromagnetica 2004/108/CE
- Direttive per basse tensioni 2006/95/CE
- RoHS II direttive 2011/65/CE (senza concorso di un citato collaboratore)

Norme applicate:

Conformemente alla lista delle norme applicate, che sono parte degli atti del prodotto.

Letzte Gültigkeit dieser Erklärung:

Entsprechend dem letzten Gültigkeitsdatum der zum Zeitpunkt der Ausstellung dieser Erklärung gültigen EG-Konformitätsbescheinigung, die durch die o.g. benannte Stelle nach Anhang V der Richtlinie 93/42/EWG ausgestellt wurde: 2017-06-09

Last validity of this declaration:

In accordance with the last date of validity of the EC certificate of conformity as issued by the above-mentioned notified body in accordance with appendix V of Directive 93/42/EEC which was valid at the time of the issuance of this declaration: 2017-06-09

Dernière validité de cette déclaration:

Conformément à la dernière date de validité de l'attestation de conformité CE valide au moment où elle a été établie par la société mentionnée ci-dessus conformément à l'annexe V de la directive 93/42/CEE : 2017-06-09

Ultima validità di questa dichiarazione:

Conformemente all'ultima data di validità del certificato di conformità CE valido al momento della pubblicazione di questa dichiarazione, che è stata esposta tramite l'ufficio sopra citato come da appendice V delle direttive 93/42/CEE: 2017-06-09

Tuttlingen, 2015-11-26



Klaus-Günter Eberle  
Geschäftsführer, Manager,  
Directeur, Gerente



**Hettich**  
LAB TECHNOLOGY

## Für dieses Gerät gültige Normen und Vorschriften

Das Gerät ist ein Produkt mit einem sehr hohen technischen Niveau. Es unterliegt umfangreichen Prüf- und Zertifizierungsverfahren gemäß folgenden Normen und Vorschriften in deren jeweils gültigen Fassung:

### Elektrische und mechanische Sicherheit für Konstruktion und Endprüfung:

Normbaureihe: IEC 61010 (entspricht der Normenreihe DIN EN 61010)

- IEC 61010-1 "Sicherheitsbestimmungen für elektrische Mess-, Steuer-, Regel- und Laborgeräte - Teil 1: Allgemeine Anforderungen" (Verschmutzungsgrad 2, Überspannungskategorie II)
- IEC 61010-2-010 "Sicherheitsbestimmungen für elektrische Mess-, Steuer-, Regel- und Laborgeräte – Teil 2-010: Besondere Anforderungen an Laborgeräte für das Erhitzen von Stoffen" (nur für Zentrifugen mit Heizung gültig)
- IEC 61010-2-020 "Sicherheitsbestimmungen für elektrische Mess-, Steuer-, Regel- und Laborgeräte - Teil 2-020: Besondere Anforderungen an Laborzentrifugen"
- IEC 61010-2-101 "Sicherheitsbestimmungen für elektrische Mess-, Steuer-, Regel- und Laborgeräte - Teil 2-101: Besondere Anforderungen an In-vitro-Diagnostik (IVD) Medizingeräte"

### Elektromagnetische Verträglichkeit:

- EN 61326-1 "Elektrische Mess-, Steuer-, Regel- und Laborgeräte - EMV-Anforderungen - Teil 1: Allgemeine Anforderungen"

### Risikomanagement:

- DIN EN ISO 14971 "Anwendung des Risikomanagements auf Medizinprodukte"

### Beschränkung gefährlicher Stoffe (RoHS II):

- EN 50581 „Technische Dokumentation zur Beurteilung von Elektro- und Elektronikgeräten hinsichtlich der Beschränkung gefährlicher Stoffe“

### Für Konformitätsbewertungsverfahren geltende Europäische Richtlinien:

- Richtlinie 93/42/EEC über Medizinprodukte (Medizinprodukte der Klasse 2a)  
EG-Konformitätsbewertungsverfahren gemäß Anhang V  
"EG-KONFORMITÄTSERKLÄRUNG (Qualitätssicherung Produktion)" und Anhang VII  
"EG-KONFORMITÄTSERKLÄRUNG (Eigenerklärung des Herstellers)".  
Das Zertifikat Anhang V wird durch die folgende benannte Stelle ausgestellt:

MEDCERT GmbH – Benannte Stelle CE 0482  
Tel: +49 (0)40 - 22633250  
Fax: +49 (0)40 - 226332515  
E-Mail: info@medcert.de  
Website: www.med-cert.com  
Post: Pilatuspool 2, D-20355 Hamburg; Deutschland

- Richtlinie 2011/65/EU zur Beschränkung der Verwendung bestimmter gefährlicher Stoffe in Elektro- und Elektronikgeräten. Das EG-Konformitätsbewertungsverfahren erfolgt hierzu in alleiniger Verantwortung des Herstellers, ohne Beteiligung einer benannten Stelle.

### Außerhalb Europas geltende Richtlinien für Medizinprodukte:

- **USA:** QSR, 21CFR 820 "CFR Title 21 - Food and Drugs: TITLE 21- FOOD AND DRUGS, CHAPTER I - FOOD AND DRUG ADMINISTRATION DEPARTMENT OF HEALTH AND HUMAN SERVICES, SUBCHAPTER H - MEDICAL DEVICES, Part 820 QUALITY SYSTEM REGULATIONS"
- **Kanada:** CMDR, SOR/98-282 "Medical Devices Regulations"

### Zertifiziertes Qualitätsmanagementsystem gemäß

- ISO 9001 "Qualitätsmanagementsysteme - Anforderungen"
- ISO13485 "Qualitätsmanagementsysteme für Medizinprodukte - Anforderungen für regulatorische Zwecke"

### Umweltmanagementsystem gemäß

- ISO 14001 "Umweltmanagementsysteme - Spezifikation mit Anleitung zur Anwendung"

## Standards and regulations which apply to this device

The device is a high-end technical product. It is subject to extensive testing and certification procedures according to the following standards and regulations in their respectively valid version:

### Electrical and mechanical safety for design and final testing:

Standard series: IEC 61010 (conform to standards of DIN EN 61010)

- IEC 61010-1 "Safety requirements for electrical equipment for measurement, control, and laboratory use - Part 1: General requirements" (Pollution Degree 2, Excess-voltage category II)
- IEC 61010-2-010 "Safety requirements for electrical equipment for measurement, control and laboratory use - Part 2-010: Particular requirements for laboratory equipment for the heating of materials" (applied to heated centrifuges only)
- IEC 61010-2-020 "Safety requirements for electrical equipment for measurement, control, and laboratory use - Part 2-020: Particular requirements for laboratory centrifuges"
- IEC 61010-2-101 "Safety requirements for electrical equipment for measurement, control and laboratory use - Part 2-101: Particular requirements for in vitro diagnostic (IVD) medical equipment"

### Electromagnetic Compatibility:

- EN 61326-1 "Electrical equipment for measurement, control and laboratory use - EMC requirements - Part 1: General requirements"

### Risk management:

- DIN EN ISO 14971 "Application of risk management to medical devices"

### Restriction of Hazardous Substances (RoHS II):

- EN 50581 "Technical documentation for assessing electric and electronic devices with regard to the restriction of hazardous substances"

### European directives applied for conformity assessment procedures:

- Medical device directive 93/42/EEC (class 2a medical products)  
EC conformity assessment procedure according to annex V  
"EC DECLARATION OF CONFORMITY (production quality assurance)" and annex VII  
"EC DECLARATION OF CONFORMITY (self-declaration by the manufacturer)".  
The annex V certificate is issued by following notified body:

MEDCERT GmbH – Notified Body CE 0482  
tel: +49 (0)40 - 22633250  
fax: +49 (0)40 - 226332515  
e-mail: info@medcert.de  
website: www.med-cert.com  
mail: Pilatuspool 2, D-20355 Hamburg; Germany

- Directive 2011/65/EU for the restriction of use of certain hazardous substances in electric and electronic devices. Carrying out the EC conformity assessment process is the sole responsibility of the manufacturer, without the involvement of a notified body.

### Applied medical device regulations outside Europe:

- **USA:** QSR, 21CFR 820 "CFR Title 21 - Food and Drugs: TITLE 21- FOOD AND DRUGS, CHAPTER I - FOOD AND DRUG ADMINISTRATION DEPARTMENT OF HEALTH AND HUMAN SERVICES, SUBCHAPTER H - MEDICAL DEVICES, Part 820 QUALITY SYSTEM REGULATIONS"
- **Canada:** CMDR, SOR/98-282 "Medical Devices Regulations"

### Certified quality management system according to

- ISO 9001 "Quality management systems – Requirements"
- ISO13485 "Medical devices - Quality management systems - Requirements for regulatory purposes"

### Environmental management system according to

- ISO 14001 "Environmental management systems - Requirements with guidance for use"

## Normes et règles en vigueur pour cet appareil

Cet appareil est un produit avec un très haut niveau technique. Il est soumis à des vastes procédures de vérification et de certification, d'après les normes et prescriptions suivantes, dans leur version actuelle :

### Sécurité électrique et mécanique pour la construction et l'inspection finale :

Série de normes : IEC 61010 (correspond à la série de norme DIN EN 61010)

- IEC 61010-1 "Règles de sécurité pour appareils électriques de mesure, de régulation et de laboratoire - partie 1 : Prescriptions générales" (niveau de saleté 2, catégorie de surtension II)
- IEC 61010-2-010 "Règles de sécurité pour appareils électriques de mesure, de régulation et de laboratoire – partie 2-010 : Prescriptions particulières pour appareils de laboratoire utilisés pour l'échauffement des matières" (seulement valable pour centrifugeuses avec chauffage)
- IEC 61010-2-020 "Règles de sécurité pour appareils électriques de mesure, de régulation et de laboratoire – partie 2-020 : Prescriptions particulières pour centrifugeuses de laboratoire"
- IEC 61010-2-101 "Règles de sécurité pour appareils électriques de mesure, de régulation et de laboratoire – partie 2-101 : Prescriptions particulières pour les appareils médicaux de diagnostic in vitro (DIV)"

### Compatibilité électromagnétique :

- EN 61326-1 "Matériel électrique de mesure, de commande et de laboratoire – Exigences relatives à la CEM - partie 1 : Exigences générales"

### Gestion des risques :

- DIN EN ISO 14971 "Application de la gestion des risques aux dispositifs médicaux"

### Restrictions relatives aux substances dangereuses (RoHS II):

- Norme européenne 50581 „Documentation technique pour l'évaluation des produits électriques et électroniques par rapport à la restriction des substances dangereuses“

### Directives européennes valables pour des procédures d'évaluation de la conformité :

- directive 93/42/EEC relative aux dispositifs médicaux (dispositifs médicaux de la classe 2a) procédure d'évaluation de la conformité CE d'après l'annexe V "DÉCLARATION CE DE CONFORMITÉ (Assurance de la qualité de la production)" et annexe VII "DÉCLARATION CE DE CONFORMITÉ (déclaration spécifique du fabricant)".  
Le certificat de l'annexe V est établi par l'organisme accrédité suivant :

MEDCERT GmbH – organisme accrédité CE 0482  
Tél : +49 (0)40 - 22633250  
Fax : +49 (0)40 - 226332515  
Courriel : info@medcert.de  
Site web : www.med-cert.com  
Adresse : Pilatuspool 2, D-20355 Hambourg ; Allemagne

- Directives 2011/65/UE concernant les restrictions relatives à l'utilisation de certaines substances dangereuses dans les appareils électriques et électroniques. La procédure d'évaluation de la conformité CE est sous la seule responsabilité du fabricant, sans participation d'un organisme désigné.

### Directives pour dispositifs médicaux, valables en dehors de l'Europe :

- **USA:** QSR, 21CFR 820 "CFR Title 21 - Food and Drugs : TITLE 21- FOOD AND DRUGS, CHAPTER I - FOOD AND DRUG ADMINISTRATION DEPARTMENT OF HEALTH AND HUMAN SERVICES, SUBCHAPTER H - MEDICAL DEVICES, Part 820 QUALITY SYSTEM REGULATIONS"
- **Canada:** CMDR, SOR/98-282 "Medical Devices Regulations"

### Système de management de la qualité certifié d'après

- ISO 9001 "Systèmes de management de la qualité - Prescriptions"
- ISO13485 "Dispositifs médicaux - Systèmes de management de la qualité - Exigences à des fins réglementaires"

### Système de management environnemental d'après

- ISO 14001 "Systèmes de management environnemental - Spécification avec description pour application"

## Norme e direttive valide per questo apparecchio

L'apparecchio è un dispositivo di elevatissimo livello tecnico. È sottoposto a numerosi procedimenti di collaudo e certificazione, in conformità alle seguenti norme e direttive nella corrispondente versione di validità:

### Sicurezza elettrica e meccanica per la costruzione ed il collaudo finale:

Serie di norma: IEC 61010 (corrisponde alla serie di norma DIN EN 61010)

- IEC 61010-1 "Norme di sicurezza per apparecchiature elettriche di misurazione, di comando, di regolazione e di laboratorio - parte 1: Requisiti generali" (grado di imbrattamento 2, Categoria di sovratensione II)
- IEC 61010-2 -010 "Norme di sicurezza per apparecchiature elettriche di misurazione, di comando, di regolazione e di laboratorio - parte 2-010: Requisiti particolari per le apparecchiature di laboratorio per il riscaldamento di materiali" (valido solo per centrifughe con riscaldamento)
- IEC 61010-2 -020 "Norme di sicurezza per apparecchiature elettriche di misurazione, di comando, di regolazione e di laboratorio - parte 2-020: Requisiti particolari per centrifughe di laboratorio"
- IEC 61010-2 -101 "Norme di sicurezza per apparecchiature elettriche di misurazione, di comando, di regolazione e di laboratorio - parte 2-101: Requisiti particolari per la diagnostica In-vitro (IVD) apparecchiature medicali"

### Compatibilità elettromagnetica:

- EN 61326-1 "Apparecchiature elettriche di misurazione, di comando, di regolazione e di laboratorio - requisiti di compatibilità elettromagnetica - parte 1: Requisiti generali"

### Gestione dei rischi:

- DIN EN ISO 14971 "Applicazione della gestione dei rischi ai dispositivi medici"

### Restrizione per prodotti pericolosi (RoHS II):

- EN 50581 „Documentazione tecnica per la stesura di un protocollo di valutazione delle apparecchiature elettriche ed elettroniche per quanto riguarda la restrizione per prodotti pericolosi“

### Direttive europee che sono di validità per il procedimento di valutazione della conformità:

- Direttive 93/42/EEC per prodotti medicali (prodotti medicali della classe 2a)  
Procedimento di dichiarazione di conformità CE conforme all'appendice V  
"DICHIARAZIONE DI CONFORMITÀ CE (assicurazione di qualità della produzione)" ed appendice VII  
"DICHIARAZIONE DI CONFORMITÀ CE (dichiarazione propria del costruttore)".  
Il certificato di appendice V viene realizzato dal seguente ufficio:

MEDCERT GmbH – Ufficio nominato CE 0482  
Tel: +49 (0)40 - 22633250  
Fax: +49 (0)40 - 226332515  
E-Mail: info@medcert.de  
Website: www.med-cert.com  
Posta: Pilatuspool 2, D-20355 Hamburg; Germania

- Direttive 2011/65/EU per la restrizione di impiego di particolari prodotti pericolosi nelle apparecchiature elettriche ed elettroniche. Il procedimento di valutazione della conformità CE avviene al riguardo nella sola responsabilità del costruttore, senza concorso di un citato collaboratore.

### Direttive valide al di fuori dell'ambito europeo per i prodotti medicali:

- **USA:** QSR, 21CFR 820 "CFR Title 21 - Food and Drugs: TITLE 21- FOOD AND DRUGS, CHAPTER I - FOOD AND DRUG ADMINISTRATION DEPARTMENT OF HEALTH AND HUMAN SERVICES, SUBCHAPTER H - MEDICAL DEVICES, Part 820 QUALITY SYSTEM REGULATIONS"
- **Kanada:** CMDR, SOR/98-282 "Medical Devices Regulations"

### Certificato sistema di gestione della qualità, conforme a

- ISO 9001 "Requisiti per sistemi di gestione qualità"
- ISO13485 "Sistemi di gestione qualità per prodotti medicali - Requisiti per impieghi di regolazione"

### Sistema di gestione ambientale, conforme a

- ISO 14001 "Sistemi di gestione ambientale - Specificazione con istruzioni per l'applicazione"



Andreas Hettich GmbH & Co. KG  
Föhrenstraße 12, D-78532 Tuttlingen / Germany  
Phone +49 (0)7461 / 705-0  
Fax +49 (0)7461 / 705-1125  
info@hettichlab.com, service@hettichlab.com  
www.hettichlab.com



© 2003 by Andreas Hettich GmbH & Co. KG

All rights reserved. No part of this publication may be reproduced without the prior written permission of the copyright owner.

Änderungen vorbehalten! , Modifications reserved! , Sous réserve de modifications ! , Con riserva di modifiche!

AB5005DEENFRIT / Rev. 06 / 12.15

**Inhaltsverzeichnis**

1	Bestimmungsgemäße Verwendung	12
2	Restrisiken	12
3	Technische Daten	13
4	Sicherheitshinweise	15
5	Bedeutung der Symbole	17
6	Lieferumfang	17
7	Auspacken und Aufstellen der Zentrifuge	17
8	Inbetriebnahme	18
9	Deckel öffnen und schließen	18
9.1	Deckel öffnen	18
9.2	Deckel schließen	18
10	Ein- und Ausbau des Rotors	19
11	Beladen des Rotors	19
12	Verschließen von Bio-Sicherheitssystemen	20
13	Bedien- und Anzeigeelemente	20
13.1	Status-Symbole	20
13.2	Drehknopf	20
13.3	Tasten und Einstellmöglichkeiten	20
14	Zentrifugations-Parameter eingeben	21
14.1	Laufzeit	21
14.1.1	Zeitvorwahl	21
14.1.2	Dauerlauf	21
14.2	Drehzahl (RPM)	21
14.3	Relative Zentrifugalbeschleunigung (RCF/RZB)	21
14.4	An- und Auslauf-Parameter	22
14.4.1	Anlaufstufe	22
14.4.2	Anlaufzeit	22
14.4.3	Bremsstufe	22
14.4.4	Auslaufzeit	22
14.4.5	Bremsabschaltungs-Drehzahl	22
14.5	Radius/Temperatur	22
14.5.1	Radius	22
14.5.2	Temperatur (nur bei Zentrifuge mit Kühlung)	22
14.6	Automatischer Zwischenspeicher	22
15	Programmierung	23
15.1	Programm-Eingabe / -Änderung	23
15.2	Programm-Abruf	23
16	Zentrifugation	23
16.1	Zentrifugation mit Zeitvorwahl	23
16.2	Dauerlauf	23
17	Einstellungen während des Zentrifugationslaufes ändern	24
18	Integral RCF (jRCF)	24
19	Anzeige der maximalen Drehzahl des Rotors	24

20	Anzeige der maximalen RCF des Rotors .....	24
21	Not-Stop .....	24
22	Akustisches Signal .....	24
23	Betriebsstunden-Abfrage.....	24
24	Datums- und Uhrzeit-Einstellung.....	25
25	Angezeigte Zentrifugations-Daten nach dem Einschalten.....	25
26	Sofortige Anzeige der Zentrifugations-Daten nach dem Einschalten .....	25
27	Schlüsselschalter (nur bei Zentrifuge mit Schlüsselschalter) .....	25
28	Programmverknüpfung (nur bei Zentrifuge mit Programmverknüpfung) .....	26
28.1	Programme verknüpfen.....	26
28.2	Programmverknüpfung ändern .....	26
28.3	Zentrifugationslauf mit Programmverknüpfung .....	26
28.4	Programmverknüpfung löschen .....	26
29	Kühlung (nur bei Zentrifuge mit Kühlung).....	27
29.1	Standby-Kühlung .....	27
29.2	Vorkühlen des Rotors.....	27
30	Heizung (nur bei Zentrifuge mit Option Heizen/Kühlen) .....	27
31	Relative Zentrifugalbeschleunigung (RCF).....	27
32	Zentrifugation von Stoffen oder Stoffgemischen mit einer höheren Dichte als 1,2 kg/dm <sup>3</sup> .....	28
33	Rotorerkennung.....	28
34	Notentriegelung.....	28
35	Pflege und Wartung.....	29
35.1	Zentrifuge (Gehäuse, Deckel und Schleuderraum).....	29
35.1.1	Oberflächenreinigung und -pflege.....	29
35.1.2	Oberflächendesinfektion .....	29
35.1.3	Entfernen radioaktiver Verunreinigungen.....	29
35.2	Rotoren und Zubehör .....	30
35.2.1	Reinigung und Pflege.....	30
35.2.2	Desinfektion .....	30
35.2.3	Entfernen radioaktiver Verunreinigungen.....	30
35.2.4	Tragzapfen.....	31
35.2.5	Rotoren und Zubehör mit begrenzter Verwendungsdauer .....	31
35.3	Autoklavieren .....	31
35.4	Zentrifugiergefäße.....	31
36	Störungen.....	32
37	Rücksendung von Geräten.....	33
38	Entsorgung.....	33
39	Anhang / Appendix .....	105
39.1	Rotoren und Zubehör / Rotors and accessories.....	105

## 1 Bestimmungsgemäße Verwendung

Bei dem vorliegenden Gerät handelt es sich um eine Laborzentrifuge die für medizinische und in-vitro diagnostische Anwendungen geeignet ist.

Die therapeutische Zweckbestimmung mit entsprechenden Zentrifugationsgefäßen ist die Auftrennung von Blut durch Zentrifugation zum Zwecke der Transfusion oder Autotransfusion der so gewonnenen Blutbestandteile.

Die Zentrifuge ist auch geeignet menschliche Körperflüssigkeiten durch Zentrifugation für in-vitro diagnostische Zwecke vorzubereiten.

Darüber hinaus ist die Zentrifuge allgemein auch zum Trennen von Stoffen bzw. Stoffgemischen nicht menschlichen Ursprungs mit einer Dichte von max. 1,2 kg/dm<sup>3</sup> geeignet.

Die Zentrifuge darf nur von Fachpersonal in geschlossenen Laboratorien verwendet werden.

Die Zentrifuge ist nur für die oben genannten Verwendungszwecke bestimmt.

Eine andere oder darüber hinausgehende Benutzung gilt als nicht bestimmungsgemäß. Für hieraus entstehende Schäden haftet die Firma Andreas Hettich GmbH & Co. KG nicht.

Zur bestimmungsgemäßen Verwendung gehört auch das Beachten aller Hinweise aus der Bedienungsanleitung und die Einhaltung der Inspektions- und Wartungsarbeiten.

## 2 Restrisiken

Das Gerät ist nach dem Stand der Technik und den anerkannten sicherheitstechnischen Regeln gebaut.

Bei unsachgemäßer Verwendung und Behandlung können Gefahren für Leib und Leben des Benutzers oder Dritter bzw. Beeinträchtigungen an dem Gerät oder an anderen Sachwerten entstehen.

Das Gerät ist nur für die bestimmungsgemäße Verwendung, und nur in sicherheitstechnisch einwandfreiem Zustand zu benutzen.

Störungen, die die Sicherheit beeinträchtigen können, sind umgehend zu beseitigen.

## 3 Technische Daten

Hersteller	Andreas Hettich GmbH & Co. KG D-78532 Tuttlingen			
Modell	ROTO SILENTA 630 RS			
Typ	5005, 5005-20, 5005-50, SK 48.06-30	5005-80	5005-90	5005-60
Netzspannung ( $\pm 10\%$ )	400 V 3~ +N			
Netzfrequenz	50 - 60 Hz			
Anschlusswert	9700 VA	9400 VA	6600 VA	
Stromaufnahme	14 A	13.5 A	9.5 A	
Kältemittel	R 404A			----
Kapazität max.	12000 ml			
zulässige Dichte	1.2 kg/dm <sup>3</sup>			
Drehzahl (RPM)	6000			
Beschleunigung (RCF)	6520			
Kinetische Energie	215000 Nm			
Prüfpflicht (BGR 500)	ja			
Umgebungsbedingungen (EN / IEC 61010-1)	<p>nur in Innenräumen bis zu 2000 m über Normal-Null 5°C bis 40°C maximale relative Luftfeuchte 80% für Temperaturen bis 31°C, linear abnehmend bis 50% relativer Luftfeuchte bei 40°C.</p>			
– Aufstellungsort				
– Höhe				
– Umgebungstemperatur				
– Luftfeuchtigkeit				
– Überspannungskategorie (IEC 60364-4-443)	II			
– Verschmutzungsgrad	2			
Geräteschutzklasse	I			
	nicht für den Einsatz in explosionsgefährdeter Umgebung geeignet.			
EMV	EN / IEC 61326-1, Klasse B			
– Störaussendung, Störfestigkeit				
Geräuschpegel (rotorabhängig)	$\leq 62$ dB(A)		$\leq 56$ dB(A)	
Abmessungen				
– Breite	813 mm			
– Tiefe	1015 mm	1050 mm		
– Höhe	973 mm			
Gewicht	ca. 355 kg	ca. 367 kg	ca. 306 kg	ca. 303 kg

Hersteller	Andreas Hettich GmbH & Co. KG D-78532 Tuttlingen		
Modell	ROTO SILENTA 630 RS		
Typ	5005-08	5005-88	5005-98
Netzspannung	208–220 V +6/-10% 3~ (+N) +PE		
Netzfrequenz	50 - 60 Hz		
Anschlusswert	9000 VA	8700 VA	5200 VA
Stromaufnahme	25 A	24 A	14 A
Kältemittel	R 404A		
Kapazität max.	12000 ml		
zulässige Dichte	1.2 kg/dm <sup>3</sup>		
Drehzahl (RPM)	6000		
Beschleunigung (RCF)	6498		
Kinetische Energie	215000 Nm		
Prüfpflicht (BGR 500)	Ja		
Umgebungsbedingungen (EN / IEC 61010-1)	<p>nur in Innenräumen bis zu 2000 m über Normal-Null</p> <p>5°C bis 30°C   5°C bis 40°C</p> <p>maximale relative Luftfeuchte 80% für Temperaturen bis 31°C, linear abnehmend bis 50% relativer Luftfeuchte bei 40°C.</p>		
– Aufstellungsort			
– Höhe			
– Umgebungstemperatur			
– Luftfeuchtigkeit			
– Überspannungskategorie (IEC 60364-4-443)	II		
– Verschmutzungsgrad	2		
Geräteschutzklasse	I		
nicht für den Einsatz in explosionsgefährdeter Umgebung geeignet.			
EMV			
– Störaussendung, Störfestigkeit	EN / IEC 61326-1, Klasse B		
Geräuschpegel (rotorabhängig)	≤ 62 dB(A)		
Abmessungen			
– Breite	813 mm		
– Tiefe	1015 mm		
– Höhe	973 mm		
Gewicht	ca. 401 kg		

#### 4 Sicherheitshinweise



Werden nicht alle Hinweise in dieser Bedienungsanleitung befolgt, kann beim Hersteller kein Gewährleistungsanspruch geltend gemacht werden.



- Die Zentrifuge ist so aufzustellen, dass sie standsicher betrieben werden kann.
- Vor Benutzung der Zentrifuge unbedingt den Rotor auf festen Sitz prüfen.
- Während eines Zentrifugationslaufes dürfen sich gemäß EN / IEC 61010-2-020, in einem Sicherheitsbereich von 300 mm um die Zentrifuge herum, keine Personen, Gefahrstoffe und Gegenstände befinden.
- Rotoren, Gehänge und Zubehörteile, die starke Korrosionsspuren oder mechanische Schäden aufweisen, oder deren Verwendungsdauer abgelaufen ist, dürfen nicht mehr verwendet werden.
- Die Zentrifuge darf nicht mehr in Betrieb genommen werden, wenn der Schleuderraum sicherheitsrelevante Schäden aufweist.
- Bei Ausschwingrotoren müssen die Tragzapfen regelmäßig gefettet werden (Hettich-Schmierfett Nr. 4051), um ein gleichmäßiges Ausschwingen der Gehänge zu gewährleisten.
- Bei Zentrifugen ohne Temperaturregelung kann es bei erhöhter Raumtemperatur und/oder bei häufigem Gebrauch des Gerätes zur Erwärmung des Schleuderraums kommen. Eine temperaturbedingte Veränderung des Probenmaterials kann deshalb nicht ausgeschlossen werden.

- Vor Inbetriebnahme der Zentrifuge ist die Bedienungsanleitung zu lesen und zu beachten. Nur Personen, die die Bedienungsanleitung gelesen und verstanden haben, dürfen das Gerät bedienen.
- Neben der Bedienungsanleitung und den verbindlichen Regelungen der Unfallverhütung sind auch die anerkannten fachtechnischen Regeln für sicherheits- und fachgerechtes Arbeiten zu beachten. Die Bedienungsanleitung ist um Anweisungen aufgrund bestehender nationaler Vorschriften des Verwenderlandes zur Unfallverhütung und zum Umweltschutz zu ergänzen.
- Die Zentrifuge ist nach dem Stand der Technik gebaut und betriebssicher. Es können aber von ihr Gefahren für den Benutzer oder Dritte ausgehen, wenn sie nicht von geschultem Personal oder unsachgemäß oder zu nicht bestimmungsgemäßem Gebrauch eingesetzt wird.
- Die Zentrifuge darf während des Betriebs nicht bewegt oder angestoßen werden.
- Im Störfall bzw. bei der Notentriegelung nie in den sich drehenden Rotor greifen.
- Um Schäden durch Kondensat zu vermeiden, muss bei Wechsel von einem kalten in einen warmen Raum, die Zentrifuge entweder mindestens 3 Stunden im warmen Raum aufwärmen bevor sie an das Netz angeschlossen werden darf oder 30 Minuten im kalten Raum warmlaufen.
- Es dürfen nur die vom Hersteller für dieses Gerät zugelassenen Rotoren und das zugelassene Zubehör verwendet werden (siehe Kapitel "Anhang/Appendix, Rotoren und Zubehör/Rotors and accessories"). Bevor Zentrifugiergefäße verwendet werden, die nicht in Kapitel "Anhang/Appendix, Rotoren und Zubehör/Rotors and accessories" aufgeführt sind, hat sich der Benutzer beim Hersteller zu vergewissern, ob diese verwendet werden dürfen.
- Der Rotor der Zentrifuge darf nur entsprechend dem Kapitel "Beladen des Rotors" beladen werden.
- Bei der Zentrifugation mit maximaler Drehzahl darf die Dichte der Stoffe oder Stoffgemische  $1,2 \text{ kg/dm}^3$  nicht überschreiten.
- Zentrifugationen mit unzulässiger Unwucht sind nicht erlaubt.
- Die Zentrifuge darf nicht in explosionsgefährdeter Umgebung betrieben werden.
- Eine Zentrifugation mit:
  - brennbaren oder explosiven Materialien
  - Materialien, die chemisch mit hoher Energie miteinander reagieren ist verboten.

- Bei der Zentrifugation von gefährlichen Stoffen bzw. Stoffgemischen, die toxisch, radioaktiv oder mit pathogenen Mikroorganismen verseucht sind, sind durch den Benutzer geeignete Maßnahmen zu treffen.  
Es müssen grundsätzlich Zentrifugiergefäße mit speziellen Schraubverschlüssen für gefährliche Substanzen verwendet werden. Bei Materialien der Risikogruppe 3 und 4 ist zusätzlich zu den verschließbaren Zentrifugiergefäßen ein Bio-Sicherheitssystem zu verwenden (siehe Handbuch "Laboratory Bio-safety Manual" der Weltgesundheitsorganisation).  
Bei einem Bio-Sicherheitssystem verhindert eine Bioabdichtung (Dichtring) das Austreten von Tröpfchen und Aerosolen.  
Wird das Gehänge eines Bio-Sicherheitssystems ohne den Deckel verwendet, muss der Dichtring vom Gehänge entfernt werden, um eine Beschädigung des Dichtrings während des Zentrifugationslaufes zu vermeiden. Beschädigte Dichtringe dürfen nicht mehr zum Abdichten des Bio-Sicherheitssystems verwendet werden.  
Ohne Verwendung eines Bio-Sicherheitssystems ist eine Zentrifuge im Sinne der Norm EN / IEC 61010-2-020 nicht mikrobiologisch dicht.  
Beim Verschließen eines Bio-Sicherheitssystems sind die Anweisungen in Kapitel "Bio-Sicherheitssysteme verschließen" zu befolgen.  
Lieferbare Bio-Sicherheitssysteme siehe Kapitel "Anhang/Appendix, Rotoren und Zubehör/Rotors and accessories". Im Zweifelsfall sind entsprechende Informationen beim Hersteller einzuholen.
- Der Betrieb der Zentrifuge mit stark korrodierenden Stoffen, welche die mechanische Festigkeit von Rotoren, Gehängen und Zubehörteilen beeinträchtigen können, ist nicht erlaubt.
- Reparaturen dürfen nur von einer vom Hersteller autorisierten Person ausgeführt werden.
- Es dürfen nur Originalersatzteile und zugelassenes Originalzubehör der Firma Andreas Hettich GmbH & Co. KG verwendet werden.
- Es gelten die folgenden Sicherheitsbestimmungen:  
EN / IEC 61010-1 und EN / IEC 61010-2-020 sowie deren nationalen Abweichungen.
- Die Sicherheit und Zuverlässigkeit der Zentrifuge ist nur dann gewährleistet, wenn:
  - die Zentrifuge nach der Bedienungsanleitung betrieben wird.
  - die elektrische Installation, am Aufstellungsort der Zentrifuge, den Anforderungen von EN / IEC Festlegungen entspricht.
  - die in den jeweiligen Ländern vorgeschriebenen Prüfungen für die Sicherheit des Gerätes, z. B. in Deutschland nach BGV A1 und BGR 500, durch einen Sachkundigen durchgeführt werden.



## 5 Bedeutung der Symbole



Symbol am Gerät:

Achtung, allgemeine Gefahrenstelle.

Vor Benutzung des Gerätes unbedingt die Bedienungsanleitung lesen und die sicherheitsrelevanten Hinweise beachten!



Symbol in diesem Dokument:

Achtung, allgemeine Gefahrenstelle.

Dieses Symbol kennzeichnet sicherheitsrelevante Hinweise und deutet auf mögliche gefährliche Situationen hin.

Das Nichtbeachten dieser Hinweise kann zu Sach- und Personenschäden führen.



Symbol am Gerät und in diesem Dokument:

Warnung vor Biogefährdung.



Symbol am Gerät und in diesem Dokument:

Warnung vor heißer Oberfläche.

Das Nichtbeachten dieses Hinweises kann zu Sach- und Personenschäden führen.



Symbol am Gerät:

Äquipotential: Steckverbinder (PA-Stecker) für Potentialausgleich (nur bei Zentrifuge mit PA-Stecker).



Symbol am Gerät:

Schaltstellungen des Schlüsselschalters.



Symbol in diesem Dokument:

Dieses Symbol deutet auf wichtige Sachverhalte hin.



Symbol am Gerät und in diesem Dokument:

Symbol für die getrennte Sammlung von Elektro- und Elektronikgeräten, gemäß der Richtlinie 2002/96/EG (WEEE). Das Gerät gehört zur Gruppe 8 (Medizinische Geräte).

Verwendung in den Ländern der Europäischen Union sowie in Norwegen und der Schweiz.

## 6 Lieferumfang

- 4 Schwingungsdämpfer
- 1 Doppelmaulschlüssel 17/19 mm
- 1 Sechskant-Stiftschlüssel
- 1 Schmierfett für Tragzapfen
- 1 Bedienungsanleitung
- 3 Programm-Datenblatt
- 1 Hinweisblatt Verpackung
- 1 Hinweisblatt Aufstellung

Rotor(en) und das entsprechende Zubehör werden je nach Bestellung mitgeliefert.

## 7 Auspacken und Aufstellen der Zentrifuge

Die Zentrifuge gemäß den mitgelieferten Hinweisblättern AH5005XX und AH5005-01XX auspacken und aufstellen.

## 8 Inbetriebnahme

- Gemäß der Laborgerätenorm EN / IEC 61010-2-020 muss in der Gebäudeinstallation ein Notausschalter zur Trennung der Netzversorgung im Fehlerfall angebracht sein. Dieser Schalter muss abseits der Zentrifuge angebracht sein, vorzugsweise außerhalb des Raumes, in dem sich die Zentrifuge befindet, oder neben dem Ausgang dieses Raumes.
- Gemäß der Laborgerätenorm IEC 61010-1 muss in der Gebäudeinstallation ein Schalter entsprechend IEC 60947-5-3 zur Trennung der Netzversorgung des Geräts angebracht sein. Dieser Schalter muss sich in der Nähe des Geräts befinden, für den Benutzer leicht erreichbar und als Trennvorrichtung für dieses Gerät gekennzeichnet sein. Der Schalter muss außerdem gegen ein Wiedereinschalten gesichert werden können.
- Bei den Typen 5005-90, 5005-08, 5005-88 und 5005-98 handelt es sich um festangeschlossene Geräte.
- Die Typen 5005-80, 5005-90, 5005-08, 5005-88 und 5005-98 dürfen nur von autorisiertem Fachpersonal installiert werden.



Diese Geräte müssen gemäß den beigefügten Aufstellungs- und Installationshinweisen AH5005-02DE installiert werden.

- **Die Zentrifuge an einem geeigneten Platz standsicher aufstellen und nivellieren Bei der Aufstellung ist der geforderte Sicherheitsbereich gemäß EN / IEC 61010-2-020, von 300 mm um die Zentrifuge herum, einzuhalten.**



**Während eines Zentrifugationslaufes dürfen sich gemäß EN / IEC 61010-2-020, in einem Sicherheitsbereich von 300 mm um die Zentrifuge herum, keine Personen, Gefahrstoffe und Gegenstände befinden.**

- Lüftungsöffnungen dürfen nicht zugestellt werden. Es muss ein Lüftungsabstand von 300 mm um die Lüftungsschlitze oder Lüftungsöffnungen eingehalten werden.
- Zentrifuge mit PA-Stecker: Bei Bedarf den PA-Stecker an der Rückseite des Gerätes mit einem zusätzlichen medizinischen Potential-Ausgleich-System verbinden.
- Prüfen, ob die Netzspannung mit der Angabe auf dem Typenschild übereinstimmt.
- Bei den Typen 5005, 5005-50, 5005-80 und SK 48.06-30: Die Zentrifuge mit dem Anschlusskabel an eine genormte Netzsteckdose anschließen. Anschlusswert siehe Kapitel "Technische Daten".
- Den Netzschalter in der Gebäudeinstallation einschalten.
- Den Schalter an der Frontblende einschalten. Schalterstellung "I". Es erfolgt die Anzeige:
  1. Typ der Zentrifuge, 2. der zuletzt durch die Rotorerkennung erkannte Rotorcode und die maximale Drehzahl des Rotors (n-max-Rotor), 3. die Programmversion, 4. **OPEN** **OEFFNEN** .
- Den Deckel öffnen. Die Zentrifugierdaten des zuletzt benutzten Programms oder des Programms 1 werden angezeigt

## 9 Deckel öffnen und schließen

### 9.1 Deckel öffnen





Der Deckel lässt sich nur öffnen, wenn die Zentrifuge eingeschaltet ist und der Rotor stillsteht. Sollte dies nicht möglich sein, siehe Kapitel "Notentriegelung".

- Die Taste  an der Frontblende drücken. Der Deckel entriegelt motorisch, die Beleuchtung in der Taste  erlischt und in der Anzeige ändert sich das Symbol  zu Symbol .

### 9.2 Deckel schließen



Mit den Fingern nicht zwischen Deckel und Gehäuse greifen. Den Deckel nicht zuschlagen.

- Den Deckel auflegen und an dem Rohr-Griff leicht niederdrücken. Die Verriegelung erfolgt motorisch. Die Taste  leuchtet auf und in der Anzeige ändert sich das Symbol  zu Symbol .

## 10 Ein- und Ausbau des Rotors

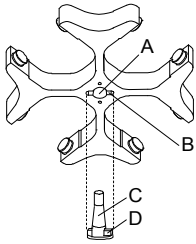

- Die Motorwelle (C) und die Bohrung des Rotors (A) reinigen und anschließend die Motorwelle leicht einfetten. Schmutzpartikel zwischen der Motorwelle und dem Rotor verhindern einen einwandfreien Sitz des Rotors und verursachen einen unruhigen Lauf.
- Den Rotor vertikal auf die Motorwelle aufsetzen. Der Mitnehmer der Motorwelle (D) muss sich in der Nut des Rotors (B) befinden. Auf dem Rotor ist die Ausrichtung der Nut gekennzeichnet.
- Die Spannmutter des Rotors mit dem mitgelieferten Schlüssel durch Drehen im Uhrzeigersinn anziehen.
- Den Rotor auf festen Sitz prüfen.
- Lösen des Rotors: Die Spannmutter durch Drehen entgegen dem Uhrzeigersinn lösen und bis zum Abhebe-Druckpunkt drehen. Nach Überwindung des Abhebe-Druckpunkts löst sich der Rotor vom Konus der Motorwelle. Die Spannmutter drehen, bis sich der Rotor von der Motorwelle abheben lässt.

## 11 Beladen des Rotors



Standard-Zentrifugiergefäße aus Glas sind belastbar bis RZB 4000 (DIN 58970 Teil 2).

- Den Rotor auf festen Sitz prüfen.
- Bei Ausschwingrotoren müssen alle Plätze des Rotors mit **gleichen** Gehängen besetzt sein. Bestimmte Gehänge sind mit der Nummer des Rotorplatzes gekennzeichnet. Diese Gehänge dürfen nur in den entsprechenden Platz des Rotors eingesetzt werden. Gehänge die mit einer Set-Nummer gekennzeichnet sind, z. B. S001/4, dürfen nur im Set verwendet werden.
- Die Rotoren und Gehänge dürfen nur symmetrisch beladen werden. Die Zentrifugiergefäße müssen gleichmäßig auf alle Plätze des Rotors verteilt werden. Zugelassene Kombinationen siehe Kapitel "Anhang/Appendix, Rotoren und Zubehör/Rotors and accessories". Bei Winkelrotoren müssen alle möglichen Plätze des Rotors beladen werden, siehe Kapitel "Anhang/Appendix, Rotoren und Zubehör/Rotors and accessories".

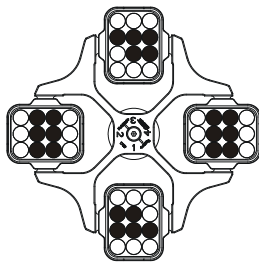

Rotor ist gleichmäßig beladen

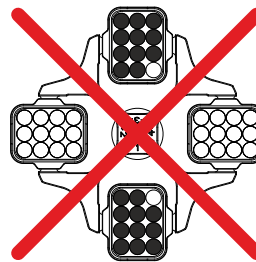

**Nicht zulässig!**

Rotor ist ungleichmäßig beladen

- Auf bestimmten Gehängen ist das Gewicht der maximalen Beladung oder das Gewicht der maximalen Beladung und das maximale Gewicht des komplett bestückten Gehänges angegeben. Diese Gewichte dürfen nicht überschritten werden. Im Ausnahmefall siehe Kapitel "Zentrifugation von Stoffen oder Stoffgemischen mit einer höheren Dichte als  $1,2 \text{ kg/dm}^3$ ". Die Gewichtsangabe der maximalen Beladung umfasst das Gesamtgewicht von Reduzierung, Gestell, Zentrifugiergefäß und Inhalt.
- Bei Behältern mit Gummieinlagen muss sich unter den Zentrifugiergefäßen immer die gleiche Anzahl von Gummieinlagen befinden
- Die Zentrifugiergefäße dürfen nur außerhalb der Zentrifuge befüllt werden.
- Die vom Hersteller angegebene maximale Füllmenge der Zentrifugiergefäße darf nicht überschritten werden. Bei Winkelrotoren dürfen die Zentrifugiergefäße nur soweit befüllt werden, dass während des Zentrifugationslaufes keine Flüssigkeit aus den Gefäßen herausgeschleudert werden kann.

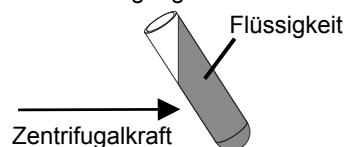

- Beim Beladen der Winkelrotoren darf keine Flüssigkeit in die Winkelrotoren und in den Schleuderraum gelangen.
- Beim Beladen der Gehänge der Ausschwingrotoren und beim Ausschwingen der Gehänge während des Zentrifugationslaufes darf keine Flüssigkeit in die Gehänge und in den Schleuderraum gelangen.
- Um die Gewichtsunterschiede innerhalb der Zentrifugiergefäße möglichst gering zu halten, ist auf eine gleichmäßige Füllhöhe in den Gefäßen zu achten.

## 12 Verschließen von Bio-Sicherheitssystemen



Um Dichtigkeit zu gewährleisten, muss der Deckel eines Bio-Sicherheitssystems fest verschlossen werden. Um ein Verdrehen des Dichtungsringes während dem Öffnen und Schließen des Deckels zu vermeiden, muss der Dichtungsring mit Talkum-Puder oder einem Gummi-Pflegemittel leicht eingerieben werden. Lieferbare Bio-Sicherheitssysteme siehe Kapitel "Anhang/Appendix, Rotoren und Zubehör/Rotors and accessories". Im Zweifelsfall sind entsprechende Informationen beim Hersteller einzuholen.

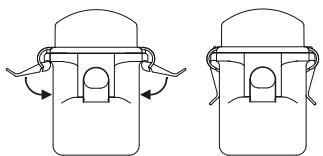

Deckel mit Spannverschluss:

- Den Deckel auf das Gehänge aufsetzen und die beiden Spannbügel soweit nach unten klappen, bis sie sich unter den Laschen des Gehänges befinden.
- Die beiden Spannbügel ganz nach unten klappen. Die Spannbügel müssen am Gehänge anliegen.

## 13 Bedien- und Anzeigeelemente

Siehe Abbildung auf Seite 2.

Fig. 2: Anzeige- und Bedienfeld

### 13.1 Status-Symbole



Deckel geöffnet.



Deckel geschlossen.



Rotationsanzeige. Die Anzeige erfolgt während des Zentrifugationslaufes, solange der Rotor dreht.

**STOP**

Zentrifugationslauf gestoppt oder beendet. Anzeige nach Beendigung des Zentrifugationslaufes, solange der Rotor dreht. Nach einem Not-Stop blinkt die Anzeige.

**LOCK 1,  
LOCK 2**

Schaltstellung des Schlüsselschalters.

**LOCK 4,  
LOCK 5**

Programmverriegelung bei Serieller Kommunikation (nur bei Zentrifuge mit serieller Kommunikation).

**PC, PE**

Serielle Kommunikation (nur bei Zentrifuge mit serieller Kommunikation).

Bedienfehler bzw. auftretende Störungen werden im Display symbolisiert (siehe Kapitel "Störungen").

### 13.2 Drehknopf



Zum Einstellen der einzelnen Parameter.

Drehen entgegen dem Uhrzeigersinn erniedrigt den Wert. Drehen im Uhrzeigersinn erhöht den Wert.

### 13.3 Tasten und Einstellmöglichkeiten



Laufzeit, Parameter t/min:sec

1. Parameter t/min: Einstellbar von 1 - 999 min, in 1 min-Schritten.
2. Parameter t/:sec Einstellbar von 1 - 59 s, in 1 Sekunden-Schritten.
3. Dauerlauf "---:--"



Abfrage des Integral RCF, Parameter ∫RCF.



1. Drehzahl, Parameter RPM

Einstellbar ist ein Zahlenwert von 50 RPM bis zur maximalen Drehzahl des Rotors (n-max-Rotor). Maximale Drehzahl des Rotors siehe Kapitel "Anhang/Appendix, Rotoren und Zubehör/Rotors and accessories". Einstellbar in 10er Schritten.









2. Abfrage der maximalen Drehzahl des Rotors, Parameter n-max-Rotor.



1. Relative Zentrifugalbeschleunigung, Parameter RCF/RZB

Einstellbar ist ein Zahlenwert, der eine Drehzahl zwischen 50 RPM und der maximalen Drehzahl des Rotors (n-max-Rotor) ergibt. Einstellbar in 1er Schritten.

2. Abfrage der maximalen RCF des Rotors, Parameter RCF-max-Rotor.



-  **Anlauf-Parameter**
1. Anlaufstufen, Parameter  $\sqrt{\text{.1-9}}$ . Stufe 9 = kürzeste Anlaufzeit, ... Stufe 1 = längste Anlaufzeit.
  2. Anlaufzeit, Parameter  $\sqrt{\text{min:sec}}$ . Der einstellbare Zeitbereich ist von der eingestellten Drehzahl abhängig.
-  **Auslauf-Parameter**
1. Bremsstufen, Parameter  $\sqrt{\text{0-9}}$ . R = Lineare Bremskurve, B = ähnlich einer exponentiellen Bremskurve. Stufe R9, B9 = kurze Auslaufzeit, ... Stufe R1, B1 = lange Auslaufzeit, Stufe R0 = ungebremster Auslauf.
  2. Auslaufzeit, Parameter  $\sqrt{\text{min:sec}}$ . Der einstellbare Zeitbereich ist von der eingestellten Drehzahl abhängig.
  3. Bremsabschaltungs-Drehzahl, Parameter  $n^{(r)}/\text{RPM}$   
Nach Erreichen dieser Drehzahl erfolgt der ungebremste Auslauf.
-  **Temperatur-Sollwert, Parameter T/°C.** Einstellbar von -20°C bis +40°C, in 1°C-Schritten (bei Option Heizen/Kühlen von -20°C bis +90°C einstellbar). Die tiefste erreichbare Temperatur ist rotorabhängig (siehe Kapitel "Anhang/Appendix, Rotoren und Zubehör/Rotors and accessories").
- Zentrifugerradius, Parameter r/mm.** Eingabe in mm. Zentrifugerradius siehe Kapitel "Anhang/Appendix, Rotoren und Zubehör/Rotors and accessories".
-  **START**
1. Zentrifugationslauf starten. Die Rotationsanzeige  erfolgt.
  2. Übernahme von Änderungen während des Zentrifugationslaufes.
-  **STOP**
- Zentrifugationslauf beenden.  
Der Rotor läuft mit dem vorgewählten Auslauf-Parameter aus. Zweimaliges Drücken der Taste löst den Not-Stop aus.
-  **PROG**
- Programmplatz anwählen, Parameter PROG-Nr.
-  **RCL**
- Abrufen von Programmen.
-  **STO**
- Speichern von Programmen.  
89 Programme können gespeichert werden (Programmplätze 1 bis 89). Hinweis: Die Programmplätze "----" und 90 bis 99 dienen als automatischer Zwischenspeicher (siehe Kapitel "Automatischer Zwischenspeicher"). Auf diese Programmplätze können keine Programme gespeichert werden.

## 14 Zentrifugations-Parameter eingeben

 Die Eingabe eines Parameters ist nur möglich, wenn das Eingabefeld invers (dunkel hinterlegt) angezeigt wird. Ein inverses Eingabefeld erlischt automatisch nach 10 Sekunden.

### 14.1 Laufzeit



#### 14.1.1 Zeitvorwahl

- Die Taste  so oft drücken, bis der Parameter t/min: oder t/:sec angezeigt wird. Das Eingabefeld wird invers angezeigt.
- Mit dem Drehknopf  den gewünschten Wert einstellen.



#### 14.1.2 Dauerlauf

- Die Parameter t/min: und t/:sec nacheinander anwählen (siehe Kapitel "Zeitvorwahl"), und beide mit dem Drehknopf  auf Null stellen. Im Eingabefeld wird "---:--" angezeigt.

### 14.2 Drehzahl (RPM)

- Die Taste  so oft drücken, bis der Parameter RPM angezeigt und das Eingabefeld invers angezeigt wird.
- Mit dem Drehknopf  den gewünschten Wert einstellen.

### 14.3 Relative Zentrifugalbeschleunigung (RCF/RZB)

- Die Taste  so oft drücken, bis der Parameter RCF/RZB angezeigt und das Eingabefeld invers angezeigt wird.
- Mit dem Drehknopf  den gewünschten Wert einstellen.

Während der Einstellung blinkt die Anzeige des Zentrifugerradius.

## 14.4 An- und Auslauf-Parameter

Die eingestellten An- und Auslauf-Parameter werden angezeigt.



x: 1-9 = Anlaufstufe, t = Anlaufzeit

y: R1-R9, B1-B9 = Bremsstufe, R0 = ungebremster Auslauf, t = Auslaufzeit,  $n^{(*)}$  = Bremsabschaltungs-Drehzahl

### 14.4.1 Anlaufstufe

- Die Taste so oft drücken, bis der Parameter oder angezeigt wird. Das Eingabefeld wird invers angezeigt.
- Mit dem Drehknopf die gewünschte Stufe einstellen.

### 14.4.2 Anlaufzeit

- Die Taste so oft drücken, bis der Parameter angezeigt wird. Das Eingabefeld wird invers angezeigt.
- Mit dem Drehknopf den gewünschten Wert einstellen.

Wird eine Anlaufzeit eingestellt die länger als die Laufzeit ist, so endet der Zentrifugationslauf bevor die eingestellte Drehzahl erreicht wird.

### 14.4.3 Bremsstufe

- Die Taste so oft drücken, bis der Parameter oder angezeigt wird. Das Eingabefeld wird invers angezeigt.
- Mit dem Drehknopf die gewünschte Stufe einstellen.

B-Bremsstufen können nur bei speziellen Rotoren eingestellt werden.

### 14.4.4 Auslaufzeit

Ist eine Bremsabschaltungs-Drehzahl eingestellt, so ist keine Auslaufzeit einstellbar.

- Die Taste so oft drücken, bis der Parameter angezeigt wird. Das Eingabefeld wird invers angezeigt.
- Mit dem Drehknopf den gewünschten Wert einstellen.

### 14.4.5 Bremsabschaltungs-Drehzahl

- Die Taste so oft drücken, bis der Parameter  $n^{(*)}$ /RPM angezeigt wird. Das Eingabefeld wird invers angezeigt.
- Mit dem Drehknopf den gewünschten Wert einstellen.

## 14.5 Radius/Temperatur

### 14.5.1 Radius

- Die Taste so oft drücken, bis der Parameter r/mm angezeigt und das Eingabefeld invers angezeigt wird.
- Mit dem Drehknopf den gewünschten Wert einstellen.

Durch Verändern des Radius passt sich der Wert der RCF/RZB automatisch an, dies wird durch Blinken angezeigt.

### 14.5.2 Temperatur

- Die Taste so oft drücken, bis der Parameter T/°C angezeigt und das Eingabefeld invers angezeigt wird.
- Mit dem Drehknopf den gewünschten Wert einstellen.

## 14.6 Automatischer Zwischenspeicher

Der Zwischenspeicher umfasst die Programmplätze "----" und 90 bis 99. Nach jedem Start eines Zentrifugationslaufes werden geänderte Zentrifugations-Daten automatisch auf Programmplatz "----" gespeichert. Die geänderten Zentrifugations-Daten, der letzten 11 Zentrifugationsläufe, sind im Zwischenspeicher gespeichert und können abgerufen werden (siehe Kapitel "Programm-Abwurf").

## 15 Programmierung

### 15.1 Programm-Eingabe / -Änderung

- Die gewünschten Parameter einstellen (siehe Kapitel "Zentrifugations-Parameter eingeben").
- Die Taste **(PROG)** drücken, um den Parameter PROG-Nr anzuwählen. Das Eingabefeld wird invers angezeigt.
- Mit dem Drehknopf  den gewünschten Programmplatz einstellen.  
Blinkt die Anzeige des Programmplatzes, so ist dieser Programmplatz bereits mit Zentrifugations-Daten belegt. In diesem Fall einen freien Programmplatz einstellen, oder durch Fortfahren die Zentrifugations-Daten überschreiben.
- Die Taste **(STO)** 1x drücken, um die Einstellungen auf dem gewünschten Programmplatz zu speichern.  
Die Taste **(STO)** 2x drücken, um bereits gespeicherte Zentrifugations-Daten zu überschreiben.

### 15.2 Programm-Abwurf

- Die Taste **(PROG)** drücken, um den Parameter PROG-Nr anzuwählen. Das Eingabefeld wird invers angezeigt.
- Mit dem Drehknopf  den gewünschten Programmplatz einstellen.
- Die Taste **(RCL)** drücken. Die Zentrifugations-Daten des angewählten Programmplatzes werden angezeigt.

## 16 Zentrifugation



Während eines Zentrifugationslaufes dürfen sich gemäß EN / IEC 61010-2-020, in einem Sicherheitsbereich von 300 mm um die Zentrifuge herum, keine Personen, Gefahrstoffe und Gegenstände befinden.



Wird der zulässige Gewichtsunterschied innerhalb der Beladung des Rotors überschritten, schaltet der Antrieb während des Anlaufs ab und **IMBALANCE / UNWUCHT** wird angezeigt.

Ist die Drehzahl im angewählten Programm höher als die maximale Drehzahl des Rotors (n-max-Rotor), kann kein Zentrifugationslauf gestartet werden. Es wird **N > ROTOR MAX 96** angezeigt (siehe Kapitel "Störungen").

Ein Zentrifugationslauf kann jederzeit durch Drücken der Taste **(STOP)** abgebrochen werden.



Mit den Tasten **(R)** und **(RCF)** kann jederzeit zwischen der RPM- und RCF-Anzeige umgeschaltet werden. Wird mit der RCF-Anzeige gearbeitet, ist die Eingabe des Zentrifugerradius notwendig.

Wird **⚡ OPEN ⚡ OEFFNEN** angezeigt, so ist eine weitere Bedienung der Zentrifuge erst nach einmaligem Öffnen des Deckels möglich.

Wird **R xx n-max xxxxx** angezeigt, so hat kein Zentrifugationslauf stattgefunden, weil zuvor der Rotor gewechselt wurde, siehe Kapitel "Rotor-Erkennung".



- Den Netzschalter einschalten. Schalterstellung I.
- Den Rotor beladen und den Zentrifugendeckel schließen.

### 16.1 Zentrifugation mit Zeitvorwahl

- Zeit einstellen oder ein Programm mit Zeitvorwahl abrufen (siehe Kapitel "Zentrifugations-Parameter eingeben" oder "Programm-Abwurf").
- Die Taste **(START)** drücken. Die Rotationsanzeige  erfolgt solange der Rotor dreht.
- Nach Ablauf der Zeit oder bei Abbruch des Zentrifugationslaufes durch Drücken der Taste **(STOP)**, erfolgt der Auslauf mit dem angewählten Auslauf-Parameter. Nach Stillstand des Rotors blinkt das Symbol  in der Anzeige, bis der Deckel geöffnet wird.

Während des Zentrifugationslaufes werden die Drehzahl des Rotors oder der daraus resultierende RCF-Wert, die Proben-Temperatur, und die verbleibende Zeit angezeigt.

### 16.2 Dauerlauf

- Symbol **---** einstellen oder ein Dauerlauf-Programm abrufen (siehe Kapitel "Zentrifugations-Parameter eingeben" oder "Programm-Abwurf").
- Die Taste **(START)** drücken. Die Rotationsanzeige  erfolgt solange der Rotor dreht. Die Zeitzählung beginnt bei 00:00.
- Die Taste **(STOP)** drücken, um den Zentrifugationslauf zu beenden. Der Auslauf erfolgt mit dem angewählten Auslauf-Parameter. Nach Stillstand des Rotors blinkt das Symbol  in der Anzeige, bis der Deckel geöffnet wird.

Während des Zentrifugationslaufes werden die Drehzahl des Rotors oder der daraus resultierende RCF-Wert, die Proben-Temperatur, und die gelaufene Zeit angezeigt.

## 17 Einstellungen während des Zentrifugationslaufes ändern

Die Laufzeit, die Drehzahl, die Relative Zentrifugalbeschleunigung (RCF/RZB), die Anlauf- und Auslauf-Parameter sowie die Temperatur können während des Zentrifugationslaufes verändert werden.

Die Parameter können nur einzeln und nacheinander verändert werden.

- Den gewünschten Parameter anwählen und mit dem Drehknopf  $\odot$  den Wert verändern (siehe Kapitel "Zentrifugations-Parameter eingeben").
- Die Taste **START** drücken. Die geänderte Einstellung wird auf Programmplatz "----" gespeichert (siehe Kapitel "Automatischer Zwischenspeicher"). Das originale Programm wird nicht überschrieben.

## 18 Integral RCF (IRCF)

Das Integral RCF (IRCF) ist ein Maß für die Sedimentationswirkung ( $\int n^2 dt$ ). Dieser Zahlenwert dient zum Vergleich von Zentrifugationsläufen. Zur Abfrage des Integral RCF die Taste **IRCF** gedrückt halten.

## 19 Anzeige der maximalen Drehzahl des Rotors

- Die Taste **n** so oft drücken, bis der Parameter RPM angezeigt und das Eingabefeld invers angezeigt wird.
- Die Taste **n** noch 1x drücken und gedrückt halten, die maximale Drehzahl des Rotors (n-max-Rotor) wird angezeigt.

## 20 Anzeige der maximalen RCF des Rotors

- Die Taste **RCF** so oft drücken, bis der Parameter RCF/RZB angezeigt und das Eingabefeld invers angezeigt wird.
- Die Taste **RCF** noch 1x drücken und gedrückt halten, die maximale RCF des Rotors (RCF-max-Rotor) wird angezeigt.

## 21 Not-Stop

- Die Taste **STOP** 2x drücken. Das Symbol **STOP** blinkt in der Anzeige.

Beim Not-Stop erfolgt der Auslauf mit Bremsstufe R9 (kürzeste Auslaufzeit). War die Bremsstufe R0 vorgewählt, so ist die Auslaufzeit technisch bedingt länger als mit Bremsstufe R9.

## 22 Akustisches Signal

Das akustische Signal ertönt nach folgender Einstellung:

<b>OFF</b>	<ul style="list-style-type: none"> <li>• bei Auftreten einer Störung im 2 s-Intervall.</li> </ul>
<b>ON1</b>	<ul style="list-style-type: none"> <li>• bei Auftreten einer Störung im 2 s-Intervall.</li> <li>• nach Beendigung des Zentrifugationslaufes und Stillstand des Rotors im 30 s-Intervall.</li> </ul>
<b>ON2</b>	<ul style="list-style-type: none"> <li>• bei Auftreten einer Störung im 2 s-Intervall.</li> <li>• nach Beendigung des Zentrifugationslaufes und Stillstand des Rotors im 30 s-Intervall.</li> <li>• bei jedem Tastendruck.</li> </ul>

Durch Öffnen des Deckels oder Drücken einer beliebigen Taste wird das akustische Signal beendet.

Das Signal kann, bei Stillstand des Rotors, folgendermaßen eingestellt werden:

- Den Deckel öffnen.
- Die Taste **t** 8 Sekunden gedrückt halten.  
Nach 8 Sekunden wird **SOUND / BELL XXX** angezeigt.
- Mit dem Drehknopf  $\odot$  die gewünschte Funktion (OFF, ON1, ON2) einstellen.
- Die Taste **START** drücken, um die Einstellung zu speichern.  
Als Bestätigung wird kurzzeitig **\*\*\* ok \*\*\*** angezeigt.

## 23 Betriebsstunden-Abfrage

Die Abfrage der Betriebsstunden ist nur bei Stillstand des Rotors möglich.

- Den Deckel öffnen.
- Die Taste **t** 8 Sekunden gedrückt halten.  
Nach 8 Sekunden wird **SOUND / BELL XXX** angezeigt.
- Die Taste **t** noch 1x drücken.  
Die Betriebsstunden (**CONTROL:** ) der Zentrifuge werden angezeigt.  
Die Betriebsstunden-Anzeige erlischt automatisch nach 10 Sekunden.



## 24 Datums- und Uhrzeit-Einstellung

Die Datums- und Uhrzeit-Einstellung ist nur bei Stillstand des Rotors möglich.

- Den Deckel öffnen.
- Die Taste **[T]** 8 Sekunden gedrückt halten.  
Nach 8 Sekunden wird **SOUND / BELL XXX** angezeigt.
- Die Taste **[T]** noch 2x drücken.  
Das Datum und die Uhrzeit werden angezeigt (a: Jahr, mon: Monat, d: Tag, h: Stunden, min: Minuten).
- Die Taste **[ ]** so oft drücken bis das Eingabefeld des gewünschten Parameters invers angezeigt wird.
- Mit dem Drehknopf **○** den gewünschten Wert einstellen.
- Die Taste **[START]** drücken, um die Einstellung zu speichern.  
Als Bestätigung wird kurzzeitig **\*\*\* ok \*\*\*** angezeigt.
- Zum Verlassen der Datums- und Uhrzeit-Einstellung eine beliebige Taste, außer den Tasten **[ ]**, **[T]** und **[START]**, drücken.

## 25 Angezeigte Zentrifugations-Daten nach dem Einschalten

Nach dem Einschalten werden die Zentrifugations-Daten des Programms 1, oder die des zuletzt benutzten Programms angezeigt. Dies kann wie folgt eingestellt werden:

- Den Deckel öffnen.
- Den Netzschalter ausschalten und wieder einschalten. Schalterstellung **I**.
- Bei der ersten optischen Änderung in der Anzeige (inverse Anzeige) die Taste **[STOP]** drücken.  
**PROGRAM 1, LAST PROGRAM** wird angezeigt.
- Mit dem Drehknopf **○** die gewünschte Funktion einstellen.
- Die Taste **[START]** drücken, um die Einstellung zu speichern.  
Als Bestätigung wird kurzzeitig **\*\*\* ok \*\*\*** angezeigt.

## 26 Sofortige Anzeige der Zentrifugations-Daten nach dem Einschalten

- Den Netzschalter einschalten. Schalterstellung **I**.
- Bei der ersten optischen Änderung in der Anzeige (inverse Anzeige) eine beliebige Taste, außer der Taste **[STOP]**, drücken. Die Zentrifugations-Daten werden sofort angezeigt.

## 27 Schlüsselschalter

Mit dem Schlüsselschalter können folgende Programm-Verriegelungen eingestellt werden:

Linke Schlüssel-Stellung: **LOCK 1** wird angezeigt.

Programme können nur abgerufen, jedoch nicht verändert werden.

Rechte Schlüssel-Stellung: **LOCK 2** wird angezeigt.

Es können keine Programme abgerufen und verändert werden.

Mittlere Schlüssel-Stellung: keine Status-Anzeige.

Keine Programmverriegelung. Programme können abgerufen und geändert werden.

## 28 Programmverknüpfung (nur bei Zentrifuge mit Programmverknüpfung)

Mit Hilfe der Programmverknüpfung können mehrere Zentrifugationsläufe miteinander verknüpft werden.

### 28.1 Programme verknüpfen



Eine Programmverknüpfung ist nur mit Programmen möglich, bei denen Anlauf- und Bremsstufen eingestellt sind.

Die Programme müssen vor der Verknüpfung entweder durch Programm-Eingabe oder Programm-Abruf in der gewünschten Reihenfolge gespeichert werden (siehe Kapitel "Programmierung").

Die Programmplätze müssen hintereinander liegen (z.B. Programmplätze 10+11+12).

1. Die Taste **PROG** drücken, um den Parameter PROG-Nr anzuwählen. Das Eingabefeld wird invers angezeigt.
2. Mit dem Drehknopf  $\odot$  den Programmplatz des Anfangs-Programms (XX+) einstellen.
3. Die Taste **RCL** drücken. Die Zentrifugations-Daten des angewählten Programmplatzes werden angezeigt.
4. Die Taste **PROG** 2x drücken, um den Parameter PR-PART anzuwählen. Das Eingabefeld wird invers angezeigt.
5. Die Taste **STO** 2x drücken. Das Programm wird verknüpft und die Programmnummer des nächsten Programmplatzes (+XX+) wird angezeigt.
6. Die Taste **RCL** 2x drücken. Die Zentrifugations-Daten des angewählten Programmplatzes werden angezeigt.
7. Die Taste **STO** 2x drücken. Das Programm wird verknüpft und die Programmnummer des nächsten Programmplatzes (+XX+) wird angezeigt.
8. Die Schritte 6 und 7 so oft wiederholen, bis alle Programme verknüpft sind.
9. Zum Beenden die Taste **PROG** drücken. Die Programmnummer des End-Programms (+XX) wird angezeigt.

### 28.2 Programmverknüpfung ändern

- Das gewünschte Programm abrufen (siehe Kapitel "Programm-Abruf"), die gewünschten Parameter ändern (siehe Kapitel "Zentrifugations-Parameter eingeben"), und die geänderten Zentrifugations-Daten wieder auf demselben Programmplatz speichern (siehe Kapitel "Programm-Eingabe / -Änderung"). Durch die Speicherung wird die Programmverknüpfung aufgehoben.
- Die Programme wieder verknüpfen (siehe Kapitel "Programme verknüpfen").

### 28.3 Zentrifugationslauf mit Programmverknüpfung

- Die Taste **PROG** 2x drücken, um den Parameter PR-PART anzuwählen. Das Eingabefeld wird invers angezeigt.
- Mit dem Drehknopf  $\odot$  den Programmplatz des Anfangs-Programms (XX+) einstellen.
- Die Taste **RCL** drücken. Die Zentrifugations-Daten des angewählten Programmplatzes werden angezeigt.
- Die Taste **START** drücken. Die Rotationsanzeige  $\odot$  erfolgt solange der Rotor dreht.  
Die Anlauf- und Bremsstufen der Programmverknüpfung werden angezeigt:

 Anfangs-Programm (XX+)  
x: Anlaufstufe des Anfangs-Programms

 Folge-Programm (+XX+)  
x: Anlaufstufe des Folge-Programm

 End-Programm (+XX)  
x: Anlaufstufe des End-Programm  
y: Bremsstufe des End-Programms

- Nach Ablauf der Zeit im End-Programm, erfolgt der Auslauf mit der Bremsstufe des End-Programms. Bei Abbruch des Zentrifugationslaufes durch Drücken der Taste **STOP**, erfolgt der Auslauf mit der Bremsstufe des gerade laufenden Programms.

### 28.4 Programmverknüpfung löschen

- Die Taste **PROG** drücken, um den Parameter PROG-Nr anzuzeigen. Das Eingabefeld wird invers angezeigt.
- Mit dem Drehknopf  $\odot$  den Programmplatz des Anfangs-Programms (XX+) einstellen.
- Die Taste **RCL** drücken. Die Zentrifugations-Daten des angewählten Programmplatzes werden angezeigt.
- Die Taste **PROG** 2x drücken, um den Parameter PR-PART anzuzeigen. Das Eingabefeld wird invers angezeigt.
- Die Taste **STO** 2x drücken.
- Die Taste **PROG** drücken.

## 29 Kühlung (nur bei Zentrifuge mit Kühlung)

Der Temperatur-Sollwert kann von -20°C bis +40°C eingestellt werden. Bei Zentrifugen mit Option Heizen/Kühlen ist der Temperatur-Sollwert von -20°C bis +90°C einstellbar. Die tiefste erreichbare Temperatur ist rotorabhängig (siehe Kapitel "Anhang/Appendix, Rotoren und Zubehör/Rotors and accessories"). Weicht die Ist-Temperatur von der Soll-Temperatur um mehr als 5 °C ab, wird dies durch eine blinkende Anzeige des Temperaturwertes signalisiert.

### 29.1 Standby-Kühlung

Bei Stillstand des Rotors und geschlossenem Deckel wird der Schleuderraum auf die vorgewählte Temperatur gekühlt. Im Display wird der Temperatur-Sollwert angezeigt.

### 29.2 Vorkühlen des Rotors

Zum schnellen Vorkühlen des unbeladenen Rotors und des Zubehörs, empfiehlt sich ein Zentrifugationslauf mit den Einstellungen Dauerlauf und einer Drehzahl von ca. 20% der maximalen Drehzahl des Rotors.

## 30 Heizung (nur bei Zentrifuge mit Option Heizen/Kühlen)

Während des Zentrifugationslaufes wird bei Bedarf der Schleuderraum auf die vorgewählte Temperatur geheizt. Bei Stillstand des Rotors ist die Heizung ausgeschaltet



Verbrennungsgefahr! Die Oberflächen-Temperatur des Heizelements im Schleuderraum der Zentrifuge kann bis zu 500°C / 932°F betragen. Das Heizelement nicht berühren.

Während eines Zentrifugationslaufes mit sehr hoher Temperatur (z.B. +90°C), erhitzt sich die Deckel-Innenseite des Gerätes. In diesem Fall die Innenseite des Deckels nicht berühren.

## 31 Relative Zentrifugalbeschleunigung (RCF)

Die relative Zentrifugalbeschleunigung (RCF) wird als Vielfaches der Erdbeschleunigung (g) angegeben. Sie ist ein einheitsfreier Zahlenwert und dient zum Vergleich der Trenn- und Sedimentationsleistung.

Die Berechnung erfolgt nach der Formel:

$$\text{RCF} = \left( \frac{\text{RPM}}{1000} \right)^2 \times r \times 1,118 \quad \Rightarrow \quad \text{RPM} = \sqrt{\frac{\text{RCF}}{r \times 1,118}} \times 1000$$

RCF = Relative Zentrifugalbeschleunigung

RPM = Drehzahl

r = Zentrifugerradius in mm = Abstand von der Mitte der Drehachse bis zum Zentrifugiergefäßboden.  
Zentrifugerradius siehe Kapitel "Anhang/Appendix, Rotoren und Zubehör/Rotors and accessories".



Die relative Zentrifugalbeschleunigung (RCF) ist von der Drehzahl und dem Zentrifugerradius abhängig.

### 32 Zentrifugation von Stoffen oder Stoffgemischen mit einer höheren Dichte als 1,2 kg/dm<sup>3</sup>

Bei der Zentrifugation mit maximaler Drehzahl darf die Dichte der Stoffe oder Stoffgemische 1,2 kg/dm<sup>3</sup> nicht überschreiten.

Bei Stoffen oder Stoffgemischen mit einer höheren Dichte muss die Drehzahl reduziert werden.

Die erlaubte Drehzahl lässt sich nach folgender Formel berechnen:

$$\text{Reduzierte Drehzahl } (n_{\text{red}}) = \sqrt{\frac{1,2}{\text{höhere Dichte [kg/dm}^3]}} \times \text{maximale Drehzahl [RPM]}$$

z.B.: Maximale Drehzahl 4000 RPM, Dichte 1,6 kg/dm<sup>3</sup>

$$n_{\text{red}} = \sqrt{\frac{1,2 \text{ kg/dm}^3}{1,6 \text{ kg/dm}^3}} \times 4000 \text{ RPM} = 3464 \text{ RPM}$$

Wird im Ausnahmefall die, auf dem Gehänge angegebene, maximale Beladung überschritten, muss die Drehzahl ebenfalls reduziert werden.

Die erlaubte Drehzahl lässt sich nach folgender Formel berechnen:

$$\text{Reduzierte Drehzahl } (n_{\text{red}}) = \sqrt{\frac{\text{maximale Beladung [g]}}{\text{tatsächliche Beladung [g]}}} \times \text{maximale Drehzahl [RPM]}$$

z.B.: Maximale Drehzahl 4000 RPM, maximale Beladung 300 g, tatsächliche Beladung 350 g

$$n_{\text{red}} = \sqrt{\frac{300 \text{ g}}{350 \text{ g}}} \times 4000 \text{ RPM} = 3703 \text{ RPM}$$

Bei eventuellen Unklarheiten ist Auskunft beim Hersteller einzuholen.

### 33 Rotorerkennung

Nach Start eines jeden Zentrifugationslaufes wird eine Rotorerkennung durchgeführt.

Wurde der Rotor gewechselt, wird der Zentrifugationslauf nach der Rotorerkennung abgebrochen. Der Rotorcode (rot xx) des Rotors wird angezeigt. Der Rotorcode (R xx) sowie die maximale Drehzahl (n-max=xxxxx) des Rotors werden angezeigt.



Eine weitere Bedienung der Zentrifuge ist erst nach einmaligem Öffnen des Deckels möglich.

Wenn die maximale Drehzahl des verwendeten Rotors kleiner als die eingestellte Drehzahl ist, wird die Drehzahl auf die maximale Drehzahl des Rotors begrenzt.

### 34 Notentriegelung

Bei einem Stromausfall kann der Deckel nicht motorisch entriegelt werden. Es muss eine Notentriegelung von Hand durchgeführt werden.



Zur Notentriegelung die Zentrifuge vom Netz trennen. Bei fest angeschlossenen Geräten, den Netzschalter zur Trennung der Netzversorgung des Geräts in der Gebäudeinstallation ausschalten und gegen ein Wiedereinschalten sichern, z. B. durch Abschließen des Schalters.

Den Deckel nur bei Stillstand des Rotors öffnen.

Siehe Abbildung auf Seite 2.

- Den Schalter an der Frontblende ausschalten (Schalterstellung "0").
- Durch das Fenster im Deckel schauen, um sich zu vergewissern, dass der Rotor stillsteht.
- Den Sechskant-Stiftschlüssel waagrecht in die Bohrung (Fig. 1, A) einführen und vorsichtig eine halbe Umdrehung im Uhrzeigersinn drehen, bis sich der Deckel öffnen lässt.
- Den Sechskant-Stiftschlüssel wieder aus der Bohrung herausziehen.
- Nach dem Wiedereinschalten der Zentrifuge die Taste  drücken, dass die motorische Deckelverriegelung wieder die Grundstellung (geöffnet) einnimmt.

## 35 Pflege und Wartung



Das Gerät kann kontaminiert sein.



Vor der Reinigung den Netzstecker ziehen. Bei fest angeschlossenen Geräten, den Netzschalter zur Trennung der Netzversorgung des Geräts in der Gebäudeinstallation ausschalten und gegen ein Wiedereinschalten sichern, z. B. durch Abschließen des Schalters.

Bevor ein anderes als das vom Hersteller empfohlene Reinigungs- oder Dekontaminationsverfahren angewandt wird, hat sich der Benutzer beim Hersteller zu vergewissern, dass das vorgesehene Verfahren das Gerät nicht schädigt.

- Zentrifugen, Rotoren und das Zubehör dürfen nicht in Spülmaschinen gereinigt werden.
- Es darf nur eine Handreinigung und eine Flüssig-Desinfektion durchgeführt werden.
- Die Wassertemperatur muss 20 – 25°C betragen.
- Es dürfen nur Reinigungs- oder Desinfektionsmittel verwendet werden, die:
  - im pH-Bereich 5 - 8 liegen,
  - keine Ätzalkalien, Peroxide, Chlorverbindungen, Säuren und Laugen enthalten.
- Um Korrosionserscheinungen durch Reinigungs- oder Desinfektionsmittel zu vermeiden sind die speziellen Anwendungshinweise vom Hersteller des Reinigungs- oder Desinfektionsmittels unbedingt zu beachten.

### 35.1 Zentrifuge (Gehäuse, Deckel und Schleuderraum)

#### 35.1.1 Oberflächenreinigung und -pflege

- Das Gehäuse der Zentrifuge und den Schleuderraum regelmäßig säubern und bei Bedarf mit Seife oder einem milden Reinigungsmittel und einem feuchten Tuch reinigen. Dies dient zum einen der Hygiene und es verhindert Korrosion durch anhaftende Verunreinigungen.
- Inhaltsstoffe geeigneter Reinigungsmittel:  
Seife, anionische Tenside, nichtionische Tenside.
- Nach dem Einsatz von Reinigungsmitteln, die Reste des Reinigungsmittels, durch Nachwischen mit einem feuchten Tuch, entfernen.
- Die Flächen müssen unmittelbar nach der Reinigung getrocknet werden.
- Bei Bildung von Kondenswasser den Schleuderraum, durch Auswischen mit einem saugfähigen Tuch, trocknen.
- Die Gummidichtung des Schleuderraums nach jeder Reinigung mit Talkum-Puder oder einem Gummi-Pflegemittel leicht einreiben.
- Der Schleuderraum ist jährlich auf Schäden zu überprüfen.



Werden sicherheitsrelevante Schäden festgestellt, darf die Zentrifuge nicht mehr in Betrieb genommen werden. In diesem Fall ist der Kundendienst zu benachrichtigen.

#### 35.1.2 Oberflächendesinfektion

- Gelangt infektiöses Material in den Schleuderraum, so ist dieser umgehend zu desinfizieren.
- Inhaltsstoffe geeigneter Desinfektionsmittel:  
Äthanol, n-Propanol, Ethylhexanol, anionische Tenside, Korrosionsinhibitoren.
- Nach dem Einsatz von Desinfektionsmitteln, die Reste des Desinfektionsmittels, durch Nachwischen mit einem feuchten Tuch, entfernen.
- Die Flächen müssen unmittelbar nach der Desinfektion getrocknet werden.

#### 35.1.3 Entfernen radioaktiver Verunreinigungen

- Das Mittel muss speziell für das Entfernen radioaktiver Verunreinigungen ausgewiesen sein.
- Inhaltsstoffe geeigneter Mittel für das Entfernen radioaktiver Verunreinigungen:  
Anionische Tenside, nichtionische Tenside, polyhydrierter Äthanol.
- Nach dem Entfernen der radioaktiven Verunreinigungen, die Reste des Mittels, durch Nachwischen mit einem feuchten Tuch, entfernen.
- Die Flächen müssen unmittelbar nach dem Entfernen der radioaktiven Verunreinigungen getrocknet werden.

## 35.2 Rotoren und Zubehör

### 35.2.1 Reinigung und Pflege

- Um einer Korrosion und Materialveränderungen vorzubeugen müssen die Rotoren und das Zubehör regelmäßig mit Seife oder einem milden Reinigungsmittel und einem feuchten Tuch gereinigt werden. Die Reinigung wird mindestens einmal wöchentlich empfohlen. Verschmutzungen müssen sofort entfernt werden.
- Inhaltsstoffe geeigneter Reinigungsmittel:  
Seife, anionische Tenside, nichtionische Tenside.
- Nach dem Einsatz von Reinigungsmitteln, die Reste des Reinigungsmittels, durch Nachspülen mit Wasser (nur außerhalb der Zentrifuge) oder Nachwischen mit einem feuchten Tuch, entfernen.
- Die Rotoren und das Zubehör müssen unmittelbar nach der Reinigung getrocknet werden.
- Winkelrotoren, Behälter und Gehänge aus Aluminium sind nach dem Trocknen mit säurefreiem Fett z.B. Vaseline leicht einzufetten.
- Bei Bio-Sicherheitssystemen (lieferbare Bio-Sicherheitssysteme siehe Kapitel "Anhang/Appendix, Rotoren und Zubehör/Rotors and accessories") sind die Dichtungsringe regelmäßig (wöchentlich) zu prüfen und zu reinigen. Bei Anzeichen von Rissbildung, Versprödung oder Abnutzung ist der Dichtungsring sofort auszutauschen. Die Dichtungsringe nach jeder Reinigung mit Talkum-Puder oder einem Gummi-Pflegemittel leicht einreiben.
- Um Korrosion infolge Feuchtigkeit zwischen Rotor und Motorwelle zu verhindern, sollte der Rotor mindestens einmal im Monat ausgebaut, gereinigt und die Motorwelle leicht gefettet werden.
- Die Rotoren und das Zubehör sind wöchentlich auf Verschleiß und Korrosionsschäden zu überprüfen. Bei Ausschwingrotoren muss vor allem der Bereich der Tragzapfen und bei Gehängen die Nuten und der Boden auf Risse geprüft werden.  
Beispiel: Riss im Bereich der Nut:

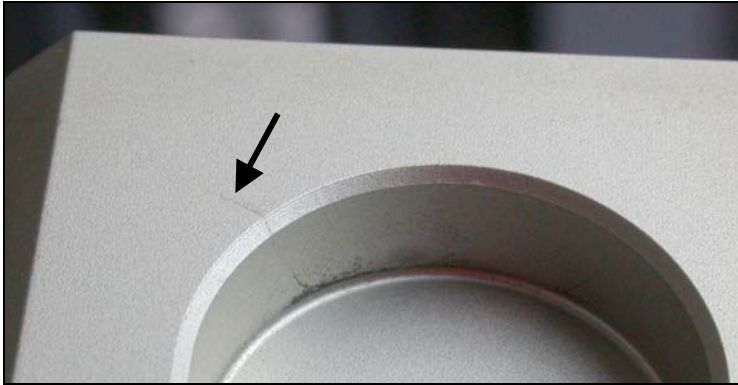

Rotoren und Zubehör dürfen bei Anzeichen von Verschleiß oder Korrosion nicht mehr verwendet werden.

- Den Rotor wöchentlich auf festen Sitz prüfen.

### 35.2.2 Desinfektion

- Gelangt infektiöses Material auf die Rotoren oder auf das Zubehör, so muss eine geeignete Desinfektion durchgeführt werden.
- Inhaltsstoffe geeigneter Desinfektionsmittel:  
Äthanol, n-Propanol, Ethylhexanol, anionische Tenside, Korrosionsinhibitoren.
- Nach dem Einsatz von Desinfektionsmitteln, die Reste des Desinfektionsmittels, durch Nachspülen mit Wasser (nur außerhalb der Zentrifuge) oder Nachwischen mit einem feuchten Tuch, entfernen.
- Die Rotoren und das Zubehör müssen unmittelbar nach der Desinfektion getrocknet werden.

### 35.2.3 Entfernen radioaktiver Verunreinigungen

- Das Mittel muss speziell für das Entfernen radioaktiver Verunreinigungen ausgewiesen sein.
- Inhaltsstoffe geeigneter Mittel für das Entfernen radioaktiver Verunreinigungen:  
Anionische Tenside, nichtionische Tenside, polyhydrierter Äthanol.
- Nach dem Entfernen der radioaktiven Verunreinigungen, die Reste des Mittels, durch Nachspülen mit Wasser (nur außerhalb der Zentrifuge) oder Nachwischen mit einem feuchten Tuch, entfernen.
- Die Rotoren und das Zubehör müssen unmittelbar nach dem Entfernen der radioaktiven Verunreinigungen getrocknet werden.

### 35.2.4 Tragzapfen

Bei Ausschwingrotoren müssen die Tragzapfen regelmäßig gefettet werden (Hettich-Schmierfett Nr. 4051), um ein gleichmäßiges Ausschwingen der Gehänge zu gewährleisten.

### 35.2.5 Rotoren und Zubehör mit begrenzter Verwendungsdauer

Die Verwendung von bestimmten Rotoren, Gehängen und Zubehörteilen ist zeitlich begrenzt.

Diese sind mit der maximal erlaubten Anzahl der Laufzyklen oder dem Ablaufdatum und der maximalen Anzahl der Laufzyklen oder nur mit dem Ablaufdatum gekennzeichnet, z.B.:

- "einsetzbar bis Ende: IV. Quartal 2011 / usable until end of: IV. Quartal 2011" oder "einsetzbar bis Ende Monat/Jahr: 10/2011 / usable until end of month/year: 10/2011"
- "max. Laufzyklen / max. cycles: 40000".



Aus Sicherheitsgründen dürfen die Rotoren, Gehänge und Zubehörteile nicht mehr verwendet werden, wenn entweder die darauf gekennzeichnete maximal erlaubte Anzahl der Laufzyklen oder das darauf gekennzeichnete Ablaufdatum erreicht ist.

### 35.3 Autoklavieren

Das folgende Zubehör darf bei 121°C / 250°F (20 min) autoklaviert werden:

- Ausschwingrotoren
- Winkelrotoren aus Aluminium
- Gehänge aus Metall
- Deckel mit Bioabdichtung
- Gestelle
- Reduzierungen

Im Zweifelsfall muss beim Hersteller nachgefragt werden.

Über den Sterilitätsgrad kann keine Aussage gemacht werden.



Die Deckel der Rotoren und Behälter müssen vor dem Autoklavieren abgenommen werden.

Das Autoklavieren beschleunigt den Alterungsprozess von Kunststoffen. Außerdem kann es bei Kunststoffen Farbveränderungen verursachen.

Wir empfehlen nach dem Autoklavieren die Dichtungsringe von Bio-Sicherheitssystemen auszutauschen.

### 35.4 Zentrifugiergefäße

- Bei Undichtigkeit oder nach dem Bruch von Zentrifugiergefäßen, sind zerbrochene Gefäßteile, Glassplitter und ausgelaufenes Zentrifugiergut vollständig zu entfernen.
- Die Gummieinlagen sowie die Kunststoff-Hülsen der Rotoren sind nach einem Glasbruch zu ersetzen.



Verbleibende Glassplitter verursachen weiteren Glasbruch !

- Handelt es sich um infektiöses Material so ist umgehend eine Desinfektion durchzuführen.

### 36 Störungen

Lässt sich der Fehler laut Störungstabelle nicht beheben, so ist der Kundendienst zu benachrichtigen.

Bitte den Zentrifugentyp und die Seriennummer angeben. Beide Nummern sind auf dem Typenschild der Zentrifuge ersichtlich.



Einen NETZ-RESET durchführen:

- Den Netzschalter ausschalten (Schalterstellung "0").
- Mindestens 10 Sekunden lang warten und anschließend den Netzschalter wieder einschalten (Schalterstellung "I").

Anzeige		Ursache	Beseitigung
keine Anzeige	---	keine Spannung. Auslösen der Überstromschutzsicherung (nur bei Zentrifugen 5005-08).	<ul style="list-style-type: none"> <li>- Versorgungsspannung überprüfen.</li> <li>- Netzschalter EIN.</li> </ul>
TACHO - ERROR	01	Tacho defekt.	<ul style="list-style-type: none"> <li>- Deckel öffnen.</li> <li>- Den Netzschalter ausschalten (Schalterstellung "0").</li> <li>- Mindestens 10 Sekunden lang warten.</li> <li>- Den Rotor von Hand kräftig drehen.</li> <li>- Den Netzschalter wieder einschalten (Schalterstellung "I"). Während des Einschaltens muss sich der Rotor drehen.</li> </ul>
	02	Kein Rotor eingebaut. Motor, Umrichter, Antrieb defekt.	
IMBALANCE / UNWUCHT	---	Der Rotor ist ungleichmäßig beladen.	<ul style="list-style-type: none"> <li>- Deckel öffnen.</li> <li>- Die Beladung des Rotors überprüfen, siehe Kapitel "Beladen des Rotors".</li> <li>- Den Zentrifugationslauf wiederholen.</li> </ul>
CONTROL - ERROR	04, 06 - 09	Fehler Deckelverriegelung	<ul style="list-style-type: none"> <li>- Einen NETZ-RESET durchführen.</li> </ul>
N > MAX	05	Überdrehzahl	
N < MIN	13	Unterdrehzahl	
ROTORCODE	10	Fehler Rotorcodierung	
MAINS INTERRUPT	---	Netzunterbrechung während des Zentrifugationslaufes. (Der Zentrifugationslauf wurde nicht beendet.)	<ul style="list-style-type: none"> <li>- Deckel öffnen.</li> <li>- Taste <b>START</b> drücken.</li> <li>- Bei Bedarf den Zentrifugationslauf wiederholen.</li> </ul>
VERSIONS-ERROR	12	Keine Übereinstimmung der Elektronik-Komponenten	<ul style="list-style-type: none"> <li>- Einen NETZ-RESET durchführen.</li> </ul>
SER I/O - ERROR	30 - 38	Fehler / Defekt Schnittstelle	
° C * - ERROR	50 - 56, 58	Fehler / Defekt Kühlung	
LOCK - ERROR	57	Fehler / Defekt Programm-Verriegelung	
FU / CCI - ERROR	60 - 83	Fehler / Defekt Motorsteuerung	
CONTROL-ERROR	26, 90 - 95, 97 - 99	Fehler / Defekt Steuerteil	
N > ROTOR-MAX	96	Drehzahl im angewählten Programm größer als die maximale Drehzahl des Rotors (n-max-Rotor).	<ul style="list-style-type: none"> <li>- Drehzahl überprüfen und korrigieren.</li> </ul>
		Der Rotor wurde gewechselt. Der eingebaute Rotor hat eine höhere maximale Drehzahl als der vorher verwendete Rotor, und er wurde noch nicht von der Rotorerkennung erkannt.	<ul style="list-style-type: none"> <li>- Eine Drehzahl, bis zur maximalen Drehzahl des vorher verwendeten Rotors, einstellen. Die Taste <b>START</b> drücken, um eine Rotorerkennung durchzuführen, siehe Kapitel "Rotorerkennung".</li> </ul>



### 37 Rücksendung von Geräten

Wird das Gerät oder dessen Zubehör an die Firma Andreas Hettich GmbH & Co. KG zurückgesandt, so muss dieses, zum Schutz von Personen, Umwelt und Material, vor dem Versand dekontaminiert und gereinigt werden.

Eine Annahme von kontaminierten Geräten oder Zubehör behalten wir uns vor.

Anfallende Kosten für Reinigungs- und Desinfektionsmaßnahmen werden dem Kunden in Rechnung gestellt.

Wir bitten dafür um Ihr Verständnis.

### 38 Entsorgung

Vor der Entsorgung muss das Gerät, zum Schutz von Personen, Umwelt und Material, dekontaminiert und gereinigt werden.

Bei der Entsorgung des Geräts sind die jeweiligen gesetzlichen Vorschriften zu beachten.

Gemäß der Richtlinie 2002/96/EG (WEEE) dürfen alle nach dem 13.08.2005 gelieferten Geräte nicht mehr mit dem Hausmüll entsorgt werden. Das Gerät gehört zur Gruppe 8 (Medizinische Geräte) und ist in den Business-to-Business-Bereich eingeordnet.



Mit dem Symbol des durchgestrichenen Abfalleimers wird darauf hingewiesen, dass das Gerät nicht mit dem Hausmüll entsorgt werden darf.

Die Entsorgungsvorschriften der einzelnen EU-Länder können unterschiedlich sein. Im Bedarfsfall wenden Sie sich bitte an Ihren Lieferanten.

**Contents**

1	Intended use .....	36
2	Remaining risks .....	36
3	Technical specifications .....	37
4	Notes on safety .....	39
5	Symbol meanings .....	41
6	Delivery checklist .....	41
7	Unpacking the centrifuge and installation .....	42
8	Initial operation .....	42
9	Opening and closing the lid .....	42
9.1	Opening the lid .....	42
9.2	Closing the lid .....	42
10	Installation and removal of the rotor .....	43
11	Loading the rotor .....	43
12	Closing biosafety systems .....	44
13	Control and display devices .....	44
13.1	Status symbols .....	44
13.2	Control knob .....	44
13.3	Keys and set-up options .....	44
14	Entering centrifugation parameters .....	45
14.1	Running time .....	45
14.1.1	Time selection .....	45
14.1.2	Continuous running .....	45
14.2	Speed (RPM) .....	45
14.3	Relative centrifugal force (RCF/RZB) .....	45
14.4	Run-up and run-down parameters .....	46
14.4.1	Run-up step .....	46
14.4.2	Run-up time .....	46
14.4.3	Braking step .....	46
14.4.4	Run-down time .....	46
14.4.5	Brake de-energisation speed .....	46
14.5	Radius/Temperature .....	46
14.5.1	Radius .....	46
14.5.2	Temperature (for centrifuges with cooling only) .....	46
14.6	Automatic buffer .....	46
15	Programming .....	47
15.1	Entering / modifying programs .....	47
15.2	Calling up programs .....	47
16	Centrifugation .....	47
16.1	Centrifugation with time selection .....	47
16.2	Continuous running .....	47
17	Changing settings during the centrifugation run .....	48
18	Integral RCF (jRCF) .....	48
19	Displaying the maximum speed of the rotor .....	48

20	Displaying the maximum RCF of the rotor.....	48
21	Emergency stop .....	48
22	Audible signal .....	48
23	Interrogating the operating hours .....	48
24	Setting the date and time .....	49
25	Centrifugation data displayed after switching on. ....	49
26	Immediate display of the centrifugation data after switching on .....	49
27	Key-operated switch (for centrifuges with key-operated switch only). ....	49
28	Program linking (for centrifuges with program linking only). ....	49
28.1	Linking programs .....	49
28.2	Changing program links .....	50
28.3	Centrifugation run with program linking.....	50
28.4	Deleting program linking .....	50
29	Cooling (only in centrifuges with cooling) .....	50
29.1	Standby-cooling .....	50
29.2	Pre-cooling the rotor.....	50
30	Heating (only on centrifuges with heating/cooling option) .....	50
31	Relative centrifugal force (RCF) .....	51
32	Centrifugation of materials or mixtures of materials with a density higher than 1.2 kg/dm <sup>3</sup> .....	51
33	Rotor recognition .....	51
34	Emergency release .....	52
35	Maintenance and servicing.....	52
35.1	Centrifuge (housing, lid and centrifuging chamber).....	52
35.1.1	Surface cleaning and care .....	52
35.1.2	Surface disinfection.....	52
35.1.3	Removal of radioactive contaminants .....	53
35.2	Rotors and Attachments.....	53
35.2.1	Cleaning and care .....	53
35.2.2	Disinfection .....	53
35.2.3	Removal of radioactive contaminants .....	54
35.2.4	Trunnions.....	54
35.2.5	Rotors and accessories with limited service lives .....	54
35.3	Autoclaving .....	54
35.4	Centrifuge containers .....	54
36	Faults .....	55
37	Returning Devices .....	56
38	Disposal .....	56
39	Anhang / Appendix.....	105
39.1	Rotoren und Zubehör / Rotors and accessories.....	105

## 1 Intended use

This device is a laboratory centrifuge which is suitable for medical and in-vitro diagnostic applications.

The therapeutic purpose with the corresponding centrifuge vessels is the separation of blood by means of centrifugation for the purpose of transfusions or autotransfusion of the won blood components.

The centrifuge is also suitable for preparing human bodily fluids by means of centrifugation for in-vitro diagnostic purposes.

Furthermore, the centrifuge is generally also suitable for separating substances or substance mixtures of non-human origin having a density of max. 1.2 kg/dm<sup>3</sup>.

The centrifuge may only be used by skilled personnel in closed laboratories.

The centrifuge is only meant for the above-named purposes.

Another use or one which goes beyond this, is considered to be non-intended. The company Andreas Hettich GmbH & Co. KG is not liable for damage resulting from this.

Observing all information in the operating instructions and complying with the measures described therein is also a part of the intended use.

## 2 Remaining risks

The device is built according to the state-of-the-art and the recognized safety regulations.

If used and handled improperly, there could be life-threatening danger to the user or third parties, or the device could be impaired or there could be other property damage.

The device is only to be used for its intended purpose and only when it is in safe working condition.

Malfunctions which could affect safety must be corrected immediately.

### 3 Technical specifications

Manufacturer	Andreas Hettich GmbH & Co. KG D-78532 Tuttlingen			
Model	ROTO SILENTA 630 RS			
Type	5005, 5005-20, 5005-50, SK 48.06-30	5005-80	5005-90	5005-60
Mains voltage ( $\pm 10\%$ )	400 V 3~ +N			
Mains frequency	50 - 60 Hz			
Connected load	9700 VA	9400 VA	6600 VA	
Current consumption	14 A	13.5 A	9.5 A	
Cooling medium	R 404A			----
Max. capacity	12000 ml			
Allowed density	1.2 kg/dm <sup>3</sup>			
Speed (RPM)	6000			
Force (RCF)	6520			
Kinetic energy	215000 Nm			
Obligatory inspection (BGR 500)	Yes			
Ambient conditions (EN / IEC 61010-1)	<p>Indoors only Up to 2000 m above sea level 5°C to 40°C Maximum relative humidity 80% for temperatures up to 31°C, linearly decreasing to 50% relative humidity at 40°C.</p>			
– Set-up site				
– Altitude				
– Ambient temperature				
– Humidity				
– Excess-voltage category (IEC 60364-4-443)	II			
– Pollution degree	2			
Device protection class	I			
	Not suitable for use in explosion-endangered areas.			
EMC	EN / IEC 61326-1, Class B			
– Emitted interference, Interference immunity				
Noise level (dependent on rotor)	$\leq 62$ dB(A)		$\leq 56$ dB(A)	
Dimensions				
– Width	813 mm			
– Depth	1015 mm	1050 mm		
– Height	973 mm			
Weight	approx. 355 kg	approx. 367 kg	approx. 306 kg	approx. 303 kg

Manufacturer	Andreas Hettich GmbH & Co. KG D-78532 Tuttlingen		
Model	ROTO SILENTA 630 RS		
Type	5005-08	5005-88	5005-98
Mains voltage	208–220 V +6/-10% 3~ (+N) +PE		
Mains frequency	50 - 60 Hz		
Connected load	9000 VA	8700 VA	5200 VA
Current consumption	25 A	24 A	14 A
Cooling medium	R 404A		
Max. capacity	12000 ml		
Allowed density	1.2 kg/dm <sup>3</sup>		
Speed (RPM)	6000		
Force (RCF)	6498		
Kinetic energy	215000 Nm		
Obligatory inspection (BGR 500)	yes		
Ambient conditions (EN / IEC 61010-1)	<p style="text-align: center;">Indoors only</p> <p style="text-align: center;">Up to 2000 m above sea level</p> <p style="text-align: center;">5°C to 30°C                                             5°C to 40°C</p> <p style="text-align: center;">Maximum relative humidity 80% for temperatures up to 31°C, linearly decreasing to 50% relative humidity at 40°C.</p>		
– Set-up site			
– Altitude			
– Ambient temperature			
– Humidity			
– Excess-voltage category (IEC 60364-4-443)	II		
– Pollution degree	2		
Device protection class	I		
Not suitable for use in explosion-endangered areas.			
EMC	EN / IEC 61326-1, Class B		
– Emitted interference, Interference immunity			
Noise level (dependent on rotor)	≤ 62 dB(A)		
Dimensions			
– Width	813 mm		
– Depth	1015 mm		
– Height	973 mm		
Weight	approx. 401 kg		

#### 4 Notes on safety



No claim of warranty will be considered by the manufacturer unless ALL instructions in this manual have been followed.



- The centrifuge should be installed on a good, stable base.
- Before using the centrifuge absolutely check the rotor for firm placement.
- When the centrifuge is running, according to EN / IEC 61010-2-020, no persons, dangerous substances or objects may be within the safety margin of 300 mm around the centrifuge.
- Rotors, suspensions and accessories that possess traces of corrosion or mechanical damage or if their term of use has expired may not be used any longer.
- The centrifuge may no longer be put into operation when the centrifuging chamber has safety-related damages.
- With swing-out rotors the trunnions must be regularly lubricated (Hettich Lubricating Grease No. 4051) in order to ensure consistent swinging out of the hangers.
- For centrifuges without temperature control, when the room temperature is increased and/or if the device is frequently used, the centrifuging chamber could be heated up. Therefore, it can't be ruled out that the sample material might be changed due to the temperature.

- Before the initial operation of your centrifuge you should read and pay attention to the operating instructions. Only personnel that has read and understood the operating instructions are allowed to operate the device.
- Along with the operating instructions and the legal regulations on accident prevention, you should also follow the recognised professional regulations for working in a safe and professional manner. These operating instructions should be read in conjunction with any other instructions concerning accident prevention and environmental protection based on the national regulations of the country where the device is to be used.
- This centrifuge is a state-of-the-art piece of equipment which is extremely safe to operate. However, it can lead to danger for users or others if used by untrained staff, in an inappropriate way or for a purpose other than that it was designed for.
- The centrifuge must not be moved or knocked during operation.
- In case of fault or emergency release, never touch the rotor before it has stopped turning.
- To avoid damage due to condensate, when changing from a cold to a warm room the centrifuge must either heat up for at least 3 hours in the warm room before being connected to the mains, or run hot for 30 minutes in the cold room.
- Only the rotors and accessories approved by the manufacturer for this device may be used (see chapter "Anhang/Appendix, Rotoren und Zubehör/Rotors and accessories"). Before centrifuge vessels are used which are not listed in the chapter "Appendix, Rotors and accessories", the user must make sure they can be used by asking the manufacturer.
- The centrifuge rotor may only be loaded in accordance with the chapter "Loading the rotor".
- When centrifuging with maxim revolutions per minute the density of the materials or the material mixtures may not exceed 1.2 kg/dm<sup>3</sup>.
- The centrifuge may only be operated when the balance is within the bounds of acceptability.
- The centrifuge may not be operated in explosion-endangered areas.
- The centrifuge must not be used with:
  - inflammable or explosive materials
  - materials that react with one another producing a lot of energy.

- If users have to centrifuge hazardous materials or compounds contaminated with toxic, radioactive or pathogenic micro-organisms, they must take appropriate measures.  
For hazardous substances centrifuge containers with special screw caps must strictly be used. In addition to the screw cap centrifuge containers, for materials in hazard category 3 and 4 a biosafety system must be used (see the World Health Organisation's "Laboratory Biosafety Manual").  
In a biosafety system, droplets and aerosols are prevented from escaping by a bioseal (packing ring).  
If the hanger of a biosafety system is used without the lid, the packing ring must be removed from the hanger in order to prevent the packing ring from being damaged during the centrifugation run. Damaged packing rings must not be used to seal the biosafety system.  
Without the use of a biosafety system the centrifuge is not microbiologically sealed in the sense of the EN / IEC 610101-2-020 standard.  
When closing a biosafety system, please observe the instructions provided in the chapter, "Closing Biosafety Systems".  
For further details of available biosafety systems see chapter "Anhang/Appendix, Rotoren und Zubehör/Rotors and accessories". If in doubt, you should obtain relevant information from the manufacturer.
- The centrifuge must not be operated with highly corrosive substances which could impair the mechanical integrity of rotors, hangers and accessories.
- Repairs must only be carried out by personnel authorised to do so by the manufacturer.
- Only original spare parts and original accessories licensed by the Andreas Hettich GmbH & Co. KG company are allowed to be utilised.
- The following safety regulations apply:  
EN / IEC 61010-1 and EN / IEC 61010-2-020 as well as their national deviations.
- The safe operation and reliability of the centrifuge can only be guaranteed if:
  - the centrifuge is operated in accordance with the operating instructions,
  - the electrical installation on the site where the centrifuge is installed conforms to the demands of EN / IEC stipulations,
  - the tests for device safety required in the respective countries, e.g. in Germany in acc. with BGV A1 and BGR 500, are carried out by an expert.



## 5 Symbol meanings



Symbol on the device:  
Attention, general hazard area.  
Before using the device, make sure you read the operating instructions and observe the safety information!



Symbol in this document:  
Attention, general hazard area.  
This symbol refers to safety relevant warnings and indicates possibly dangerous situations.  
The non-adherence to these warnings can lead to material damage and injury to personal.



Symbol on the device and in this document:  
Beware of biohazard.



Symbol on the device and in this document:  
Beware of hot surface.  
Nonobservance of this warning can lead to material damage and personal injury.



Symbol on the device:  
Equipotential: Connector (PE connector) for potential equalization (only for centrifuge with PE connector).



Symbol on the device:  
Switch positions of the key-operated switch.



Symbol in this document:  
This symbol refers to important circumstances.



Symbol on the device and in this document:  
Symbol for the separate collection of electric and electronic devices according to the guideline 2002/96/EG (WEEE). The device belongs to Group 8 (medical devices).  
Applies in the countries of the European Union, as well as in Norway and Switzerland.

## 6 Delivery checklist

- 4 Vibration absorber
- 1 Double open-end wrench 17/19 mm
- 1 Hexagonal pin-type spanner
- 1 Lubricating grease for trunnions
- 1 Operating instructions
- 3 Program-data sheet
- 1 Information on how to remove the packing
- 1 Installation information sheet

The rotor(s) and associated accessories are included in the delivery in the quantity ordered.

## 7 Unpacking the centrifuge and installation

Unpack and install the centrifuge in accordance with the instruction leaflets AH5005XX and AH5005-01XX provided.

## 8 Initial operation

- According to the laboratory instrument standards EN / IEC 61010-2-020 an emergency switch to separate power supply in the event of a failure must be installed in the building electrical system. This switch has to be placed remote from the centrifuge, preferred outside of the room in which the centrifuge is installed or near by the exit of this room.
- According to the laboratory instrument standards IEC 61010-1 a switch to separate the power supply agreeable to IEC 60947-5-3 must be installed in the building electrical system. This switch has to be placed close to the centrifuge, must be easily reachable for the user and has to be characterized as a separator for this unit. The switch must also be able to be secured against being switched on again.
- Types 5005-90, 5005-08, 5005-88 and 5005-98 are permanently connected devices.
- Types 5005-80, 5005-90, 5005-08, 5005-88 and 5005-98 may only be installed by authorized skilled personnel.



These devices must be installed according to the enclosed set-up and installation instructions, AH5005-02EN.

- **Position the centrifuge in a stable and level manner in a suitable place. During set-up, the required safety margin of 300 mm around the centrifuge is to be kept according to EN / IEC 61010-2-020.**



**When the centrifuge is running, according to EN / IEC 61010-2-020, no persons, dangerous substances or objects may be within the safety margin of 300 mm around the centrifuge.**





- Do not place any object in front of the ventiduct.  
Keep a ventilation area of 300 mm around the ventiduct.
- Centrifuge with PE connector:  
If required, connect the PE connector at the back of the device with an additional medical potential equalization system.
- Check whether the mains voltage tallies with the statement on the type plate.
- For types 5005, 5005-50, 5005-80 and SK 48.06-30:  
Connect the centrifuge with the connection cable to a standard mains socket. For connection ratings refer to Chapter "Technical specification".
- Switch on the mains switch in the building installation.
- Switch on the switch on the front panel. Switch position "I".  
The following display follows:  
1. Type of centrifuge, 2. The last rotor code detected by the rotor identification and the maximum speed of the rotor (n-max-Rotor), 3. The programme version, 4. **OPEN** **OEFFNEN**.
- Open the lid.  
The centrifuge data of the last used program or program 1 will be displayed.

## 9 Opening and closing the lid

### 9.1 Opening the lid





The lid can only be opened when the centrifuge is switched on and the rotor is at rest. If it cannot be opened under these circumstances, see the section on "Emergency release".

- Press the button  on the front panel. The lid unlocks via the motor, the illuminated pushbutton  extinguishes and in the display the symbol  changes to the symbol .

### 9.2 Closing the lid



Do not put your fingers between lid and housing.  
Do not bang the lid shut.

- Place the lid and slightly press it down at the tubular handle. The locking action is effected by motor. The button  lights up and the symbol  in the display turns to the symbol .

## 10 Installation and removal of the rotor

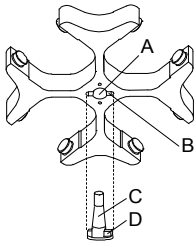

- Clean the motor shaft (C) and the rotor drilling (A), and lightly grease the motor shaft afterwards. Dirt particles between the motor shaft and the rotor hinder a perfect seating of the rotor and cause an irregular operation.
- Place the rotor vertically on the motor shaft. The motor shaft dog (D) has to fit in the rotor slot (B). The alignment of the groove is labelled on the rotor.
- Tighten the rotor tension nut with the supplied wrench by turning in a clockwise direction.
- Check the rotor for firm seating.
- Loosening the rotor: Loosen the tension nut by turning in a counter clockwise direction, and turning until the working point for lifting. After passing the working point for lifting the rotor is loosened from the motor shaft cone. Turn the tension nut until the rotor is able to be lifted from the motor shaft.

## 11 Loading the rotor



Standard centrifuge containers of glass will not stand RCF values exceeding 4000 (DIN 58970, pg. 2).

- Check the rotor for firm seating.
- With swing-out rotors all rotor positions must be lined with **identical** hangers. Certain hangers are marked with the number of the rotor position. These hangers may only be used in the respective rotor position. Hangers that are marked with a set number (e.g. S001/4) may only be used in the set.
- The rotors and hangers may only be loaded symmetrically. The centrifuge containers have to be distributed evenly on all rotor positions. For authorised combinations see Chapter "Anhang/Appendix, Rotoren und Zubehör/Rotors and accessories".  
In the case of angle rotors all possible rotor positions must be loaded, see chapter "Anhang/Appendix, Rotoren und Zubehör/Rotors and accessories".

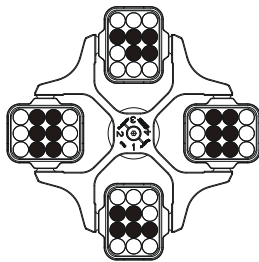

Rotor is evenly loaded

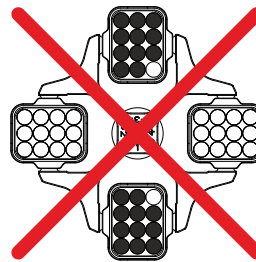

**Not permitted!**  
Rotor is not evenly loaded

- On certain hangers, the weight of the maximum load or the weight of the maximum load and the maximum weight of the completely loaded hanger is specified. This weight may not be exceeded. In case of exception, see chapter "Centrifugation of materials or mixtures of materials with a density higher than 1.2 kg/dm<sup>3</sup>". The weight specified for the maximum loading includes the total weight of adapter, frame, centrifuging container and content.
- In containers with rubber inserts, the same number of rubber inserts must always be among the centrifuge containers.
- The centrifuge containers may only be filled outside of the centrifuge.
- The maximum filling quantity for the centrifuge containers specified by the manufacturer must not be exceeded.

In the case of angle rotors, the centrifuging vessels may only be filled so far that no fluid can be expelled from them while the centrifuge is running.

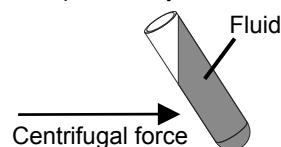

- When loading the angle rotors, no liquid may get into the angle rotors or centrifuging chamber.
- When loading the hangers and swing-out rotors and when swivelling out the hangers while the centrifuge is running, no liquid may enter the hangers or the centrifuging chamber.
- In order to maintain the weight differences within the centrifuge container as marginal as possible, a consistent fill level in the containers is to be heeded.

## 12 Closing biosafety systems



In order to guarantee that it is sealed, the lid to the biosafety system has to be firmly closed.

In order to prevent the packing ring from twisting when opening and closing the cover, the packing ring must be lightly rubbed with talcum powder or a rubber care product.

For further details of available biosafety systems see chapter "Anhang/Appendix, Rotoren und Zubehör/Rotors and accessories". If in doubt, you should obtain relevant information from the manufacturer.

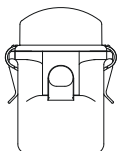
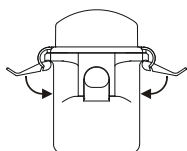

Lid with clip lock:

- Put the lid on the hanger and push down both clamps until they are underneath the loops on the hanger.
- Fold down both clamps as far as they can go. The clamps have to lie flat against the hanger.

## 13 Control and display devices

See figure on page 2.

Fig. 2: Display and operating panel

### 13.1 Status symbols



Lid open.



Lid closed.



Rotation indicator. The indication appears while the centrifuge is running as long as the rotor is turning.

**STOP**

Centrifugation run stopped or finished. Indication after completion of the centrifugation run as long as the rotor is turning. The indicator flashes following an emergency stop.

**LOCK 1,  
LOCK 2**

Keyswitch position.

**LOCK 4,  
LOCK 5**

Program interlocking when serial communication provided (for centrifuges with serial communication only).

**PC, PE**

Serial communication (for centrifuges with serial communication only).

Operating errors or faults that occur are shown symbolically in the display (see Chapter "Faults").

### 13.2 Control knob



For setting the individual parameters.

Turning anticlockwise reduces the value. Turning clockwise increases the value.

### 13.3 Keys and set-up options



Running time, parameter t/min:sec

1. Parameter t/min: Adjustable from 1 - 999 min, in 1 min steps.
2. Parameter t/ :sec Adjustable from 1 - 59 s, in 1 second steps.
3. Continuous running "---:--"



Interrogation of the integral RCF, parameter ∫RCF.



1. Speed, parameter RPM

A numerical value from 50 RPM up to the maximum speed of the rotor (n-max-Rotor) can be set. Maximum speed of the rotor, see Chapter "Anhang/Appendix, Rotoren und Zubehör/Rotors and accessories". Adjustable in steps of 10.









2. Interrogation of the maximum speed of the rotor, parameter n-max-Rotor.



1. Relative centrifugal force, parameter RCF/RZB

A numerical value can be set, which gives a speed between 50 RPM and the maximum speed of the rotor (n-max-Rotor). Adjustable in steps of 1.

2. Interrogation of the maximum RCF of the rotor, parameter RCF-max-Rotor.



-  Run-up parameters
- Run-up steps, parameter  $\sqrt{\quad}$  1-9. Step 9 = shortest run-up time, ... Step 1 = longest run-up time.
  - Run-up time, parameter  $\sqrt{\quad}$  min:sec. The time range that can be set is dependent upon the set speed.
-  Run-down parameters
- Braking steps, parameter  $\backslash\quad$  0-9. R = linear braking curve, B = similar to an exponential braking curve. Step R9, B9 = short run-down time, ... Step R1, B1 = long run-down time, Step R0 = unbraked run-down.
  - Run-down time, parameter  $\backslash\quad$  min:sec. The time range that can be set is dependent upon the set speed.
  - Brake de-energisation speed, parameter n<sup>(°)</sup>/RPM  
After reaching this speed, unbraked run-down occurs.
-  1. Temperature setpoint, parameter T/°C. Adjustable from -20°C to +40°C, in 1°C steps (heating/cooling option settable between -20°C and +90°C). The lowest temperature that can be achieved is dependent upon the rotor (see Chapter "Anhang/Appendix, Rotoren und Zubehör/Rotors and accessories").
2. Centrifuging radius, parameter r/mm. Entry in mm. Centrifuging radius, see Chapter "Anhang/Appendix, Rotoren und Zubehör/Rotors and accessories".
-  1. Start centrifugation run. The rotation indicator  appears.
2. Acceptance of changes during the centrifugation run.
-  Stop centrifugation run.  
The rotor decelerates with the preset run-down parameters. Pressing the key twice will initiate an emergency stop.
-  Select program location, parameter PROG-Nr.
-  Calling up of programs.
-  Saving of programs.  
89 programs can be saved (program locations 1 to 89). Note: The program locations "----" and 90 to 99 are used as automatic buffers (see Chapter "Automatic buffer"). No programs can be saved in these program locations.

## 14 Entering centrifugation parameters

 It is only possible to enter a parameter when the input field is displayed inversely (dark background). An inverse input field will go off automatically after 10 seconds.

### 14.1 Running time

#### 14.1.1 Time selection

- Press the  key repeatedly until the parameter t/min: or t/ :sec is displayed. The input field will be displayed inversely.
- Set the desired value by means of the control knob .



#### 14.1.2 Continuous running

- Select the parameters t/min: and t/ :sec one after the other (see Chapter "Time selection"), and set both to zero using the control knob . "----:--" will be displayed in the input field.

### 14.2 Speed (RPM)

- Press the  key repeatedly until the parameter RPM is displayed and the input field is shown inversely.
- Set the desired value by means of the control knob .

### 14.3 Relative centrifugal force (RCF/RZB)

- Press the  key repeatedly until the parameter RCF/RZB is displayed and the input field is shown inversely.
- Set the desired value by means of the control knob .

The centrifuging radius indicator will flash while the adjustment is being made.

## 14.4 Run-up and run-down parameters





The run-up and run-down parameters that have been set are displayed.





x: 1-9 = run-up step, t = run-up time

y: R1-R9, B1-B9 = braking step, R0 = unbraked run-down, t = run-down time,  $n^{(*)}$  = brake de-energisation speed

### 14.4.1 Run-up step





- Press the  key repeatedly until the parameter <sub>1-9</sub> or  is displayed. The input field will be displayed inversely.
- Set the desired step by means of the control knob .

### 14.4.2 Run-up time

- Press the  key repeatedly until the parameter <sub>min:sec</sub> is displayed. The input field will be displayed inversely.
- Set the desired value by means of the control knob .

If a run-up time is set that is longer than the running time, the centrifugation run will end before the set speed is reached.



### 14.4.3 Braking step

- Press the  key repeatedly until the parameter <sub>0-9</sub> or  is displayed. The input field will be displayed inversely.
- Set the desired step by means of the control knob .



B-braking steps can only be set for special rotors.

### 14.4.4 Run-down time

If a brake de-energisation speed has been set, it is not possible to set a run-down time.



- Press the  key repeatedly until the parameter <sub>min:sec</sub> is displayed. The input field will be displayed inversely.
- Set the desired value by means of the control knob .

### 14.4.5 Brake de-energisation speed

- Press the  key repeatedly until the parameter  $n^{(*)}/\text{RPM}$  is displayed. The input field will be displayed inversely.
- Set the desired value by means of the control knob .



## 14.5 Radius/Temperature

### 14.5.1 Radius

- Press the  key repeatedly until the parameter r/mm is displayed and the input field is shown inversely.
- Set the desired value by means of the control knob .

The value of the RCF/RZB adapts automatically when the radius is changed; this is shown by the indication flashing.

### 14.5.2 Temperature

- Press the  key repeatedly until the parameter T/°C is displayed and the input field is shown inversely.
- Set the desired value by means of the control knob .

## 14.6 Automatic buffer

The buffer comprises the program locations "----" and 90 to 99. Every time a centrifugation run is started, modified centrifugation data are automatically stored in program location "----". The modified centrifugation data for the last 11 centrifugation runs are stored in the buffer and can be called up (see Chapter "Calling up programs").

## 15 Programming

### 15.1 Entering / modifying programs

- Set the desired parameters (see Chapter "Entering centrifugation parameters").
- Press the **PROG** key in order to select the parameter PROG-Nr. The input field will be displayed inversely.
- Set the desired program location by means of the control knob  $\odot$ .  
If the program location indicator flashes, then this program location has already had centrifugation data assigned to it. In this case, set a free program location or overwrite the centrifugation data by continuing.
- Press the **STO** key once to save the settings in the desired program location.  
Press the **STO** key twice to overwrite centrifugation data already stored.

### 15.2 Calling up programs

- Press the **PROG** key in order to select the parameter PROG-Nr. The input field will be displayed inversely.
- Set the desired program location by means of the control knob  $\odot$ .
- Press the **RCL** key. The centrifugation data for the selected program location will be displayed.

## 16 Centrifugation



When the centrifuge is running, according to EN / IEC 61010-2-020, no persons, dangerous substances or objects may be within the safety margin of 300 mm around the centrifuge.



If the permissible weight difference within the rotor loading has been exceeded, the drive shuts down during the start-up, and **IMBALANCE / UNWUCHT** is displayed.

If the speed in the selected program is higher than the maximum speed of the rotor (n-max-Rotor), it will not be possible to start a centrifugation run. The message **N > ROTOR MAX 96** will be displayed (see Chapter "Faults").

A centrifugation run can be stopped at any time by pushing the key **STOP**.

It is possible to switch over between RPM and RCF display at any time using the **RPM** and **RCF** keys. When working with the RCF display, it is necessary to enter the centrifuging radius.

If **OPEN** / **OEFFNEN** is displayed, a further operation of the centrifuge is only possible after opening the lid once.

If **R xx n-max xxxxx** is displayed, then no centrifugation run has taken place as the rotor was changed beforehand, refer to Chapter "Rotor Identification".

- Switch on the mains supply switch. Switch position I.
- Load the rotor and close the centrifuge lid.

### 16.1 Centrifugation with time selection

- Set the time or call up a program with a pre-set time (see Chapter "Entering centrifugation parameters" or "Calling up programs").
- Press the **START** key. The rotation indicator  $\odot$  will appear as long as the rotor is turning.
- When the time has expired or if the centrifugation run is interrupted by pressing the **STOP** key, run-down will take place with the selected run-down parameters. When the rotor comes to a stop, the  $\square$  symbol will flash in the display until the lid is opened.

During the centrifugation run, the speed of the rotor or the RCF value resulting from this, the sample temperature and the remaining time will be displayed.

### 16.2 Continuous running

- Select the  $\text{---:--}$  symbol or call up a continuous running program (see Chapter "Entering centrifugation parameters" or "Calling up programs").
- Press the **START** key. The rotation indicator  $\odot$  will appear as long as the rotor is turning. The time count starts from 00:00.
- Press the **STOP** key to stop the centrifugation run. Run-down will take place with the selected run-down parameters. When the rotor comes to a stop, the  $\square$  symbol will flash in the display until the lid is opened.

During the centrifugation run, the speed of the rotor or the RCF value resulting from this, the sample temperature and the time run will be displayed.

## 17 Changing settings during the centrifugation run.

The running time, the speed, the relative centrifugal force (RCF/RZB), the run-up and run-down parameters as well as the temperature can be changed while the centrifuge is running.

The parameters can only be changed one at a time and in succession.

- Select the desired parameter and change the value using the control knob  $\odot$  (see Chapter "Entering centrifugation parameters").
- Press the **START** key. The modified setting will be stored in program location "----" (see Chapter "Automatic buffer"). The original program will not be overwritten.

## 18 Integral RCF (IRCF)

The integral RCF (IRCF) is a measure for the sedimentation effect ( $\int n^2 dt$ ). This numerical value is used to compare centrifugation runs. To interrogate the integral RCF, press and hold the **IRCF** key.

## 19 Displaying the maximum speed of the rotor

- Press the **n** key repeatedly until the parameter RPM is displayed and the input field is shown inversely.
- Press the **n** key once more and hold it pressed; the maximum speed of the rotor (n-max-Rotor) will be displayed.

## 20 Displaying the maximum RCF of the rotor

- Press the **RCF** key repeatedly until the parameter RCF/RZB is displayed and the input field is shown inversely.
- Press the **RCF** key once more and hold it pressed; the maximum RCF of the rotor (RCF-max-Rotor) will be displayed.

## 21 Emergency stop

- Press the **STOP** key twice. The **STOP** symbol will flash in the display.

In the case of an emergency stop, run-down takes place with braking step R9 (shortest run-down time). If braking step R0 was selected, the run-down time will be longer than with braking step R9 for technical reasons.

## 22 Audible signal

The audible signal sounds in accordance with the following philosophy:

<b>OFF</b>	<ul style="list-style-type: none"> <li>• at 2 s intervals on the occurrence of a fault</li> </ul>
<b>ON1</b>	<ul style="list-style-type: none"> <li>• at 2 s intervals on the occurrence of a fault</li> <li>• at 30 s intervals on completion of a centrifugation run and the rotor coming to rest.</li> </ul>
<b>ON2</b>	<ul style="list-style-type: none"> <li>• at 2 s intervals on the occurrence of a fault</li> <li>• at 30 s intervals on completion of a centrifugation run and the rotor coming to rest.</li> <li>• every time a key is pressed</li> </ul>

The audible signal is silenced by opening the lid or pressing any key.

The signal can be set as follows when the rotor is at standstill.

- Open the lid.
- Press and hold the **□** key for 8 seconds.  
After 8 seconds **SOUND / BELL XXX** will be displayed.
- Set the desired function (OFF, ON1, ON2) by means of the control knob  $\odot$ .
- Press the **START** key to save the setting.  
**\*\*\* ok \*\*\*** will be displayed briefly as a confirmation.

## 23 Interrogating the operating hours

It is only possible to interrogate the operating hours when the rotor is at standstill.

- Open the lid.
- Press and hold the **□** key for 8 seconds.  
After 8 seconds **SOUND / BELL XXX** will be displayed.
- Press the **□** key once more.  
The operating hours (**CONTROL:** ) for the centrifuge will be displayed.  
The operating hours display will go off automatically after 10 seconds.



## 24 Setting the date and time

It is only possible to set the date and time when the rotor is at standstill.

- Open the lid.
- Press and hold the **[ ]** key for 8 seconds.  
After 8 seconds **SOUND / BELL XXX** will be displayed.
- Press the **[ ]** key twice more.  
The date and time will be displayed (a: year, mon: month, d: day, h: hours, min: minutes).
- Press the **[ ]** key repeatedly until the input field for the desired parameter is shown inversely.
- Set the desired value by means of the control knob **○**.
- Press the **[START]** key to save the setting.  
**\*\*\* ok \*\*\*** will be displayed briefly as a confirmation.
- To exit the date and time set-up, press any key apart from the **[ ]**, **[ ]** and **[START]** keys.

## 25 Centrifugation data displayed after switching on.

After switching on, the centrifugation data for program 1 or for the program last used will be displayed. This can be set as follows:

- Open the lid.
- Switch the mains supply switch off and on again. Switch position I.
- Press the **[STOP]** key when the first visual change appears in the display (inverse display).  
**PROGRAM 1, LAST PROGRAM** will be displayed.
- Set the desired function by means of the control knob **○**.
- Press the **[START]** key to save the setting.  
**\*\*\* ok \*\*\*** will be displayed briefly as a confirmation.

## 26 Immediate display of the centrifugation data after switching on

- Switch on the mains supply switch. Switch position I.
- Press any key apart from the **[STOP]** key when the first visual change appears in the display (inverse display). The centrifugation data will be displayed immediately.

## 27 Key-operated switch.

The following program interlocks can be set by the key-operated switch:

- Left key position:     **LOCK 1** will be displayed.  
                                  Programs can be called up but not changed.
- Right key position:   **LOCK 2** will be displayed.  
                                  No programs can be called up or changed.
- Middle key position:  no status display.  
                                  No program interlock. Programs can be called up and changed.

## 28 Program linking (for centrifuges with program linking only).

Several centrifugation runs can be linked together with the help of the program linking function.

### 28.1 Linking programs



Program linking is only possible with programs in which run-up and braking steps have been set.

Before linking, the programs must be stored in the desired sequence either by entering the program or by calling up the program (see Chapter "Programming").

The program locations must be consecutive (e.g. program locations 10+11+12).

1. Press the **[PROG]** key in order to select the parameter PROG-Nr. The input field will be displayed inversely.
2. Set the program location for the first program (XX+) by means of the control knob **○**.
3. Press the **[RCL]** key. The centrifugation data for the selected program location will be displayed.
4. Press the **[PROG]** key twice in order to select the parameter PR-PART. The input field will be displayed inversely.
5. Press the **[STO]** key twice. The program will be linked and the program number for the next program location (+XX+) will be displayed.
6. Press the **[RCL]** key twice. The centrifugation data for the selected program location will be displayed.
7. Press the **[STO]** key twice. The program will be linked and the program number for the next program location (+XX+) will be displayed.
8. Keep repeating steps 6 and 7 until all programs have been linked.
9. Press the **[PROG]** key to exit. The program number for the last program (+XX) will be displayed.

## 28.2 Changing program links

- Call up the desired program (see Chapter "Calling up programs"), change the desired parameters (see Chapter "Entering centrifugation parameters"), and save the modified centrifugation data to the same program location (see Chapter "Entering / modifying programs"). As a result of saving, the program linking will be removed.
- Re-link the programs (see Chapter "Linking programs").

## 28.3 Centrifugation run with program linking

- Press the **PROG** key twice in order to select the parameter PR-PART. The input field will be displayed inversely.
- Set the program location for the first program (XX+) by means of the control knob  $\odot$ .
- Press the **RCL** key. The centrifugation data for the selected program location will be displayed.
- Press the **START** key. The rotation indicator  $\odot$  will appear as long as the rotor is turning.

The run-up and braking steps for the program linking will be displayed:

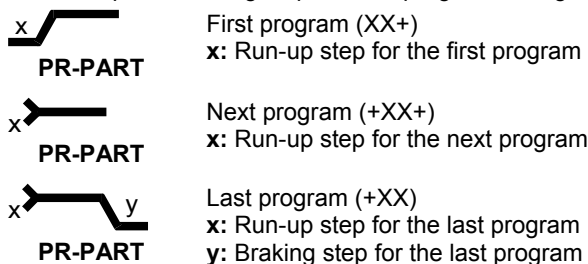

- When the time in the last program has expired, run-down will take place with the braking step of the last program. If the centrifugation run is interrupted by pressing the **STOP** key, run-down will take place with the braking step of the program running at the time.

## 28.4 Deleting program linking

- Press the **PROG** key in order to display the parameter PROG-Nr. The input field will be displayed inversely.
- Set the program location for the first program (XX+) by means of the control knob  $\odot$ .
- Press the **RCL** key. The centrifugation data for the selected program location will be displayed.
- Press the **PROG** key twice in order to display the parameter PR-PART. The input field will be displayed inversely.
- Press the **STO** key twice.
- Press the **PROG** key.

## 29 Cooling (only in centrifuges with cooling)

The temperature set-point can be adjusted from  $-20^{\circ}\text{C}$  to  $+40^{\circ}\text{C}$ . On centrifuges with a heating/cooling option, the temperature set-point is settable from  $-20^{\circ}\text{C}$  to  $+90^{\circ}\text{C}$ . The lowest obtainable temperature is dependent on the rotor (see Chapter "Anhang/Appendix, Rotoren und Zubehör/Rotors and accessories"). If the actual temperature and the set temperature deviate more than  $5^{\circ}\text{C}$ , the temperature value in the display will start to flash on and off.

### 29.1 Standby-cooling

With rotor standstill and closed lid the centrifugal chamber is cooled to the pre-selected temperature. The temperature set-point is shown in the display.

### 29.2 Pre-cooling the rotor

For rapid pre-cooling of the unloaded rotor and the accessories, it is recommended that the centrifuge is run with the continuous running settings and a speed of ca. 20% of the maximum rotor speed.

## 30 Heating (only on centrifuges with heating/cooling option)

During operation of the centrifuge the centrifuge chamber can be heated as required to the preselected temperature. The heating is switched off when the rotor is stationary.



Risk of burning! The surface temperature of the heating element in the centrifugal chamber of the centrifuge can reach  $500^{\circ}\text{C}$  /  $932^{\circ}\text{F}$ . Do not touch the heating element.

During a centrifugation run at very high temperature (e.g.  $+90^{\circ}\text{C}$ ), the inside of the device lid heats up. In this case, do not touch the inside of the lid.

### 31 Relative centrifugal force (RCF)

The relative centrifugal force (RCF) is given as a multiple of the acceleration of gravity (g). It is a unit-free value and serves to compare the separation and sedimentation performance.

These values are calculated using the formula below:

$$\text{RCF} = \left( \frac{\text{RPM}}{1000} \right)^2 \times r \times 1,118 \quad \Rightarrow \quad \text{RPM} = \sqrt{\frac{\text{RCF}}{r \times 1,118}} \times 1000$$

RCF = relative centrifugal force

RPM = rotational speed (revolutions per minute)

r = centrifugal radius in mm = distance from the centre of the turning axis to the bottom of the centrifuge.

For more on the centrifugal radius see the chapter "Anhang/Appendix, Rotoren und Zubehör/Rotors and accessories".



The relative centrifugal force (RCF) stands in relation to the revolutions per minute and the centrifugal radius.

### 32 Centrifugation of materials or mixtures of materials with a density higher than 1.2 kg/dm<sup>3</sup>

When centrifuging with maximum revolutions per minute the density of the materials or the material mixtures may not exceed 1.2 kg/dm<sup>3</sup>.

The speed must be reduced for materials or mixtures of materials with a higher density.

The permissible speed can be calculated using the following formula:

$$\text{Reduced speed } (n_{\text{red}}) = \sqrt{\frac{1.2}{\text{Greater density [kg/dm}^3]}} \times \text{maximum speed [RPM]}$$

e.g.: maximum speed RPM 4000, density 1.6 kg/dm<sup>3</sup>

$$n_{\text{red}} = \sqrt{\frac{1.2 \text{ kg/dm}^3}{1.6 \text{ kg/dm}^3}} \times 4000 \text{ RPM} = 3464 \text{ RPM}$$

In the exceptional case that the maximum loading indicated on the hanger is exceeded, the speed must also be reduced.

The permissible speed can be calculated using the following formula:

$$\text{Reduced speed } (n_{\text{red}}) = \sqrt{\frac{\text{maximum load [g]}}{\text{actual load [g]}}} \times \text{maximum speed [RPM]}$$

e.g.: maximum speed RPM 4000, maximum load 300 g, actual load 350 g

$$n_{\text{red}} = \sqrt{\frac{300 \text{ g}}{350 \text{ g}}} \times 4000 \text{ RPM} = 3703 \text{ RPM}$$

If in doubt you should obtain clarification from the manufacturer.

### 33 Rotor recognition

Rotor recognition is carried out after each start of the centrifugation run.

If the rotor has been changed, the centrifugation run is canceled after rotor recognition. The rotor code (R xx) and the maximum speed (n-max=xxxxx) of the rotor are displayed.



A further operation of the centrifuge is only possible after a single opening of the lid.

If the maximum speed of the rotor being used is less than the set speed, the speed is limited to the rotor's maximum speed.

### 34 Emergency release

During a power failure the lid cannot be unlocked by motor. An emergency release has to be executed by hand.



For emergency release disconnect the centrifuge from the mains. In the case of permanently connected devices, switch off the mains switch to disconnect the mains supply of the device in the building installation and secure it against being switched on again, e.g. by locking the switch.

Open the lid only during rotor standstill.

See figure on page 2.

- Switch off the switch on the front panel (switch position "0").
- Look through the window in the lid to be sure that the rotor has come to a standstill.
- Insert the hexagon socket head wrench horizontally into the drilling (Fig. 1, A) and carefully rotate by half a turn in clockwise direction until the lid can be opened.
- Pull the hexagon socket head wrench out of the drilling again.
- After turning the centrifuge on again, press the button  so that the motor-driven lid locking once again assumes the normal position (opened).

### 35 Maintenance and servicing



The device can be contaminated.



Pull the mains plug before cleaning. In the case of permanently connected devices, switch off the mains switch to disconnect the mains supply of the device in the building installation and secure it against being switched on again, e.g. by locking the switch.

Before any other cleaning or decontamination process other than that recommended by the manufacturer is applied, the user has to check with the manufacturer that the planned process does not damage the device.

- Centrifuges, rotors and accessories must not be cleaned in rinsing machines.
- They may only be cleaned by hand and disinfected with liquids.
- The water temperature must be between 20 – 25°C.
- Only detergents/disinfectants may be used which:
  - have a pH between 5 - 8
  - do not contain caustic alkalis, peroxides, chlorine compounds, acids and alkaline solutions
- In order to prevent appearances of corrosion through cleaning agents or disinfectants, the application guide from the manufacturer of the cleaning agent or disinfectant are absolutely to be heeded.

#### 35.1 Centrifuge (housing, lid and centrifuging chamber)

##### 35.1.1 Surface cleaning and care

- Clean the centrifuge housing and the centrifuging chamber regularly, using soap or a mild detergent and a damp cloth if required. For one thing, this services purposes of hygiene, and it also prevents corrosion through adhering impurities.
- Ingredients of suitable detergents: soap, anionic tensides, non-ionic tensides.
- After using detergents, remove the detergent residue by wiping with a damp cloth.
- The surfaces must be dried immediately after cleaning.
- In the event of condensation water formation, dry the centrifugal chamber by wiping out with an absorbent cloth.
- Lightly rub the rubber seal of the centrifuge chamber with talcum powder or a rubber care product after each cleaning.
- The centrifuging chamber is to be checked for damage once a year.



If damage is found which is relevant to safety, the centrifuge may no longer be put into operation. In this case, notify Customer Service.

##### 35.1.2 Surface disinfection

- If infectious materials penetrates into the centrifugal chamber this is to be disinfected immediately.
- Ingredients of suitable disinfectants: ethanol, n-propanol, ethyl hexanol, anionic tensides, corrosion inhibitors.
- After using disinfectants, remove the disinfectant residue by wiping with a damp cloth.
- The surfaces must be dried immediately after disinfecting.

### 35.1.3 Removal of radioactive contaminants

- The agent must be specifically labelled as being an agent for removing radioactive contaminants.
- Ingredients of suitable agents for removing radioactive contaminants: anionic tensides, non-ionic tensides, polyhydrated ethanol.
- After removing the radioactive contaminants, remove the agent residue by wiping with a damp cloth.
- The surfaces must be dried directly after removing the radioactive contaminants.

## 35.2 Rotors and Attachments

### 35.2.1 Cleaning and care

- In order to avoid corrosion and changes in materials, the rotors and accessories have to be cleaned regularly with soap or with a mild cleaning agent and a moist cloth. Cleaning is recommended at least once a week. Contaminants must be removed immediately.
- Ingredients of suitable detergents: soap, anionic tensides, non-ionic tensides.
- After using detergents, remove detergent residue by rinsing with water (only outside of the centrifuge) or wipe off with a damp cloth.
- The rotors and accessories must be dried directly after cleaning.
- Angle rotors, container and hanger made of aluminium are to be lightly greased after drying using acid-free grease, e.g. vaseline.
- In the case of biosafety systems (for further details of available biosafety systems see chapter "Anhang/Appendix, Rotoren und Zubehör/Rotors and accessories"), the packing rings must be checked and cleaned regularly (weekly). The sealing ring is to be replaced immediately upon indication of crack formation, embrittlement or abrasive wear. Lightly rub the packing rings with talcum powder or a rubber care product after each cleaning.
- In order to prevent corrosion as a result of moisture between the rotor and the motor shaft, the rotor should be disassembled and cleaned at least once a month, and the motor shaft should be lightly greased.
- The rotors and accessories have to be checked weekly for wear and corrosion. For swing-out rotors, it is important to check the area of the lifting lugs, for hangers, the grooves and the base should be checked for cracks.

Example: Crack in the groove area:

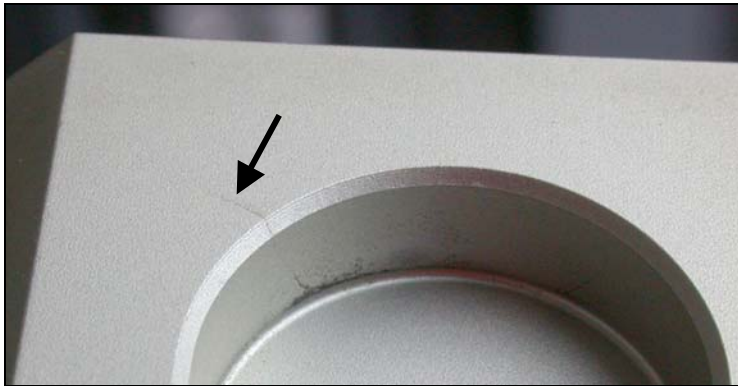

Rotors and attachments may no longer be utilised upon indication of wear and tear or corrosion.

- Check the firm seating of the rotor on a weekly basis.

### 35.2.2 Disinfection

- If infectious material should get on the rotors or accessories, they must be appropriately disinfected.
- Ingredients of suitable disinfectants: ethanol, n-propanol, ethyl hexanol, anionic tensides, corrosion inhibitors.
- After using disinfectants, remove disinfectant residue by rinsing with water (only outside of the centrifuge) or wipe off with a damp cloth.
- The rotors and accessories must be dried directly after disinfection.

### 35.2.3 Removal of radioactive contaminants

- The agent must be specifically labelled as being an agent for the removal of radioactive contaminants.
- Ingredients of suitable agents for removing radioactive contaminants: anionic tensides, non-ionic tensides, polyhydrated ethanol.
- After removing the radioactive contaminants, remove agent residue by rinsing with water (only outside of the centrifuge) or wipe off with a damp cloth.
- The rotors and accessories must be dried directly after removing the radioactive contaminants.

### 35.2.4 Trunnions

With swing-out rotors the trunnions must be regularly lubricated (Hettich Lubricating Grease No. 4051) in order to ensure consistent swinging out of the hangers.

### 35.2.5 Rotors and accessories with limited service lives

The use of certain rotors, hangers and accessory parts is limited by time.

These are marked with the maximum permitted number of operating cycles or with an expiration date and the maximum permitted number of operating cycles or just with the expiration date; e.g.:

- "einsetzbar bis Ende: IV. Quartal 2011 / usable until end of: IV. Quarter 2011" or "einsetzbar bis Ende Monat/Jahr: 10/2011 / usable until end of month/year: 10/2011"
- "Max. Lauf Zyklen / max. cycles: 40000".



For safety reasons, rotors, hangers and accessory parts may no longer be used if either the indicated maximum number of operating cycles or the indicated expiration date has been reached.

### 35.3 Autoclaving

The following accessory can be autoclaved at 121°C / 250°F (20 min):

- Swing-out rotors
- Angle rotors made of aluminum
- Hanger made of metal
- Lid with biocontainment
- Stands
- Reductions

Otherwise you must ask the manufacturer.

No statement can be made about the degree of sterility.



The lids of the rotors and containers must be removed prior to autoclaving. Autoclaving accelerates the ageing process of plastics. In addition, autoclaving may discolour plastics. We recommend that the packing rings of the bio-safety system be replaced after autoclaving.

### 35.4 Centrifuge containers

- With leakiness or after the breakage of centrifuging containers broken container parts, glass splinters and leaked centrifugation material are to be completely removed.
- The rubber inserts as well as the plastic sleeves of the rotors are to be replaced after a glass breakage.



Remaining glass splinters cause further glass breakage!

- If this concerns infectious material, a disinfection process is to be executed immediately.

### 36 Faults

If the fault cannot be eliminated with the help of the fault table, please inform Customer Service.

Please specify the type of centrifuge and the serial number. Both numbers can be found on the name plate of the centrifuge.



Perform a MAINS RESET:

- Switch off the mains switch (switch position "0").
- Wait at least 10 seconds and then switch on the mains switch again (switch position "1").

Message / fault		Cause	Remedy
No display	---	No voltage. Overvoltage protection tripped out (only for types 5005-08).	- Check supply voltage. - Mains switch ON.
TACHO - ERROR	01	Faulty speedometer.	- Open the cover. - Switch off the mains switch (switch position "0"). - Wait at least 10 seconds. - Turn the rotor vigorously by hand. - Switch on the mains switch again (switch position "1"). The rotor must turn during switch-on.
	02	No rotor installed. Defective motor, frequency converter or drive.	
IMBALANCE / UNWUCHT	---	The rotor is unevenly loaded.	- Open lid. - Check the loading of the rotor, see chapter "Loading the rotor". - Repeat the centrifugation run.
CONTROL - ERROR	04, 06 - 09	Error in lid locking or lid closure.	- Perform a MAINS RESET.
N > MAX	05	Rotation too fast	
N < MIN	13	Rotation too slow	
ROTORCODE	10	Incorrect rotor coding	
MAINS INTERRUPT	---	Power failure during the centrifugation run. (The centrifugation run was not finished.)	- Open lid. - Push <b>START</b> button. - Repeat the centrifugation run if necessary.
VERSIONS-ERROR	12	Mismatch between electronic components	- Perform a MAINS RESET.
SER I/O - ERROR	30 - 38	Error / defective interface	
° C * - ERROR	50 - 56, 58	Error / defective cooling	
LOCK - ERROR	57	Error / defective program locking	
FU / CCI - ERROR	60 - 83	Error / defective motor control	
CONTROL-ERROR	26, 90 - 95, 97 - 99	Error / defective control unit	
N > ROTOR-MAX	96	Speed in the selected program greater than the maximum speed of the rotor (n-max-Rotor).	- Check the set speed. Reduce the set speed
		The rotor has been changed. The maximum speed of the installed rotor is higher than that of the rotor that was previously used and this has not yet been detected by rotor recognition.	- Set a speed up to the maximum speed of the rotor that was previously used. Press the <b>START</b> key to run rotor recognition. See chapter, "Rotor Recognition".

### 37 Returning Devices

If the device or its accessories are returned to Andreas Hettich GmbH & Co. KG, in order to provide protection for people, the environment and materials, it has to be decontaminated and cleaned before being shipped.

We reserve the right to refuse contaminated devices or accessories.

Costs incurred for cleaning and disinfection are to be charged to the customer.

We ask for your understanding in this matter.

### 38 Disposal

Before disposal, the device must be decontaminated and cleaned to protect people, the environment and property.

When you are disposing of the device, the respective statutory rules must be observed.

Pursuant to guideline 2002/96/EC (WEEE), all devices supplied after August 13, 2005 may not be disposed as part of domestic waste. The device belongs to group 8 (medical devices) and is categorized in the business-to-business field.



The icon of the crossed-out trash can shows that the device may not be disposed as part of domestic waste.

The waste disposal guidelines of the individual EC countries might vary. If necessary, contact your supplier.



**Table des matières**

1	Utilisation conforme .....	59
2	Risques résiduels .....	59
3	Données techniques .....	60
4	Consignes de sécurité .....	62
5	Signification des symboles.....	64
6	Composition de la livraison .....	64
7	Déballer et mettre la centrifugeuse en place.....	65
8	Mise en service.....	65
9	Ouvrir et fermer le couvercle.....	65
9.1	Ouvrir le couvercle.....	65
9.2	Fermer le couvercle.....	65
10	Montage et démontage du rotor .....	66
11	Chargement du rotor .....	66
12	Fermeture des systèmes de sécurité biologique .....	67
13	Éléments de commande et d'affichage.....	67
13.1	Symboles d'état.....	67
13.2	Bouton de réglage.....	67
13.3	Touches et possibilités de réglage .....	67
14	Saisie des paramètres de centrifugation .....	68
14.1	Durée de fonctionnement.....	68
14.1.1	Présélection de la durée .....	68
14.1.2	Fonctionnement en continu.....	68
14.2	Vitesse de rotation (RPM).....	68
14.3	Accélération relative de centrifugation (RCF/RZB) .....	69
14.4	Paramètres de démarrage et paramètres de rotation par inertie .....	69
14.4.1	Niveau de démarrage .....	69
14.4.2	Temps de démarrage.....	69
14.4.3	Niveau de freinage.....	69
14.4.4	Temps de rotation par inertie .....	69
14.4.5	Nombre de tours de l'arrêt de freinage.....	69
14.5	Rayon/température .....	69
14.5.1	Rayon .....	69
14.5.2	Température (uniquement en cas de centrifugeuses avec réfrigération) .....	69
14.6	Mémoire tampon automatique .....	70
15	Programmation.....	70
15.1	Introduction de programme / modification de programme.....	70
15.2	Récupération de programme .....	70
16	Centrifugation .....	70
16.1	Centrifugation avec présélection de la durée .....	70
16.2	Fonctionnement en continu.....	71
17	Modifier des réglages pendant le processus de centrifugation.....	71
18	Integral RCF (ÍRCF) .....	71
19	Affichage de la vitesse de rotation maximale du rotor .....	71

20	Affichage de la valeur RCF maximale du rotor .....	71
21	Arrêt d'urgence .....	71
22	Signal acoustique .....	72
23	Interrogation relative au nombre d'heures de service .....	72
24	Réglage de la date et de l'heure .....	72
25	Données de centrifugation, affichées suite à la mise en service .....	72
26	Affichage immédiat des données de centrifugation suite à la mise en service .....	72
27	Interrupteur à clé (uniquement dans le cas des centrifugeuses avec interrupteur à clé) .....	73
28	Création de liens entre programmes (uniquement dans le cas de centrifugeuses dotées de la fonction de création de liens entre programmes) .....	73
28.1	Créer des liens entre programmes .....	73
28.2	Modifier les liens entre programmes .....	73
28.3	Processus de centrifugation avec lien entre programmes .....	74
28.4	Effacer des liens entre programmes .....	74
29	Refroidissement (uniquement sur centrifugeuse avec refroidissement) .....	74
29.1	Refroidissement en veilleuse .....	74
29.2	Pré-refroidissement du rotor .....	74
30	Chauffage (uniquement sur centrifugeuse avec l'option Chauffer/refroidir) .....	74
31	Accélération centrifuge relative (RCF) .....	75
32	Centrifugation de matières et de mélanges d'une densité supérieure à 1,2 kg/dm <sup>3</sup> .....	75
33	Identification du rotor .....	75
34	Déverrouillage d'urgence .....	76
35	Entretien et maintenance .....	76
35.1	Centrifugeuse (boîtier, couvercle et cuve) .....	76
35.1.1	Entretien et nettoyage des surfaces .....	76
35.1.2	Désinfection des surfaces .....	77
35.1.3	Décontamination de substances radioactives .....	77
35.2	Rotors et accessoires .....	77
35.2.1	Nettoyage et entretien .....	77
35.2.2	Désinfection .....	78
35.2.3	Décontamination de substances radioactives .....	78
35.2.4	Goupilles de fixation .....	78
35.2.5	Rotors et accessoires à durée d'utilisation limitée .....	78
35.3	Autoclavage .....	78
35.4	Réservoirs de centrifugation .....	78
36	Défauts .....	79
37	Renvoi d'appareils au fabricant .....	80
38	Élimination des déchets .....	80
39	Anhang / Appendix .....	105
39.1	Rotoren und Zubehör / Rotors and accessories .....	105

## 1 Utilisation conforme

Concernant le présent appareil, il s'agit d'une centrifugeuse de laboratoire appropriée pour les utilisations médicales et de diagnostic in-vitro.

La vocation thérapeutique avec récipients de centrifugation correspondants est la séparation du sang par centrifugation à des fins de transfusion ou d'auto-transfusion des composants de sang obtenus.

La centrifugeuse est aussi appropriée pour préparer des fluides corporels humains par centrifugation à des fins de diagnostics in-vitro.

Par ailleurs, la centrifugeuse est aussi généralement appropriée pour séparer les tissus ou les mélanges de tissus d'origine non humaine avec une densité de max. 1,2 kg/dm<sup>3</sup>.

La centrifugeuse ne doit être utilisée que par du personnel agréé dans des laboratoires fermés.

La centrifugeuse est uniquement destinée aux plages d'utilisation nommées ci-dessus.

Toute utilisation en dehors ou au delà de ce cadre est considérée comme non conforme. L'entreprise Andreas Hettich GmbH & Co. KG décline toute responsabilité pour tout dommage en résultant.

L'utilisation conforme comprend également le respect de toutes les indications contenues dans le mode d'emploi et des travaux d'inspection et d'entretien.

## 2 Risques résiduels

L'appareil est construit conformément au niveau actuel de la technologie et des règles de sécurité éprouvées.

L'utilisation et la manipulation non conforme de cet appareil risquent de menacer la santé et l'intégrité corporelle de l'utilisateur ou de tierces personnes, ou de détériorer l'appareil ou autres biens matériels.

Utilisez exclusivement l'appareil conformément à l'usage pour lequel il a été conçu et uniquement s'il est dans un état de fonctionnement technique irréprochable.

Remédier sans attendre à tout dérangement susceptible de porter atteinte à la sécurité.

## 3 Données techniques

Fabricant	Andreas Hettich GmbH & Co. KG D-78532 Tuttlingen			
Modèle	ROTO SILENTA 630 RS			
Type	5005, 5005-20, 5005-50, SK 48.06-30	5005-80	5005-90	5005-60
Tension du réseau ( $\pm 10\%$ )	400 V 3~ +N			
Fréquence du réseau	50 - 60 Hz			
Charge de connexion	9700 VA	9400 VA	6600 VA	
Consommation de courant	14 A	13.5 A	9.5 A	
Réfrigérant	R 404A			----
Capacité max.	12000 ml			
Densité admise	1.2 kg/dm <sup>3</sup>			
Vitesse de rotation (RPM)	6000			
Accélération (RCF)	6520			
Energie cinétique	215000 Nm			
Obligation de contrôle (BGR 500)	oui			
Conditions ambiantes (EN / IEC 61010-1)	<p>uniquement dans les intérieurs Jusqu'à 2000 m au dessus du niveau de la mer 5°C à 40°C</p> <p>humidité de l'air max. relative 80% pour températures jusqu'à 31°C, décroissant en linéaire jusqu'à 50% de l'humidité relative pour 40°C.</p>			
– Emplacement				
– Hauteur				
– Température ambiante				
– Humidité de l'air				
– Catégorie de surtension (IEC 60364-4-443)	II			
– Degré d'encrassement	2			
Catégorie de protection de l'appareil	I			
Non approprié pour l'usage dans un environnement exposé aux explosions.				
EMV	EN / IEC 61326-1, catégorie B			
– Emission de parasites, Résistance aux interférences				
Niveau du bruit (en fonction du rotor)	$\leq 62$ dB(A)		$\leq 56$ dB(A)	
Dimensions				
– Largeur	813 mm			
– Profondeur	1015 mm	1050 mm		
– Hauteur	973 mm			
Poids	env. 355 kg	env. 367 kg	env. 306 kg	env. 303 kg

Fabricant	Andreas Hettich GmbH & Co. KG D-78532 Tuttlingen		
Modèle	ROTO SILENTA 630 RS		
Type	5005-08	5005-88	5005-98
Tension du réseau	208-220 V +6/-10% 3~ (+N) +PE		
Fréquence du réseau	50 - 60 Hz		
Charge de connexion	9000 VA	8700 VA	5200 VA
Consommation de courant	25 A	24 A	14 A
Réfrigérant	R 404A		
Capacité max.	12000 ml		
Densité admise	1.2 kg/dm <sup>3</sup>		
Vitesse de rotation (RPM)	6000		
Accélération (RCF)	6498		
Energie cinétique	215000 Nm		
Obligation de contrôle (BGR 500)	oui		
Conditions ambiantes (EN / IEC 61010-1)	<p>uniquement dans les intérieurs</p> <p>Jusqu'à 2000 m au dessus du niveau de la mer</p> <p>5°C à 30°C   5°C à 40°C</p> <p>humidité de l'air max. relative 80% pour températures jusqu'à 31°C, décroissant en linéaire jusqu'à 50% de l'humidité relative pour 40°C.</p>		
– Emplacement			
– Hauteur			
– Température ambiante			
– Humidité de l'air			
– Catégorie de surtension (IEC 60364-4-443)	II		
– Degré d'encrassement	2		
Catégorie de protection de l'appareil	I		
Non approprié pour l'usage dans un environnement exposé aux explosions.			
EMV	EN / IEC 61326-1, catégorie B		
– Emission de parasites, Résistance aux interférences			
Niveau du bruit (en fonction du rotor)	≤ 62 dB(A)		
Dimensions			
– Largeur	813 mm		
– Profondeur	1015 mm		
– Hauteur	973 mm		
Poids	env. 401 kg		

#### 4 Consignes de sécurité



**Aucune demande garantie ne pourra être revendiquée auprès du fabricant si les indications données dans ce mode d'emploi ne sont pas toutes respectées.**



- **Veiller à la stabilité de la centrifugeuse.**
- **Avant d'utiliser la centrifugeuse, il est indispensable de vérifier la fixation correcte du rotor.**
- **Durant un processus de centrifugation, aucune personne, matière dangereuse et aucun objet ne doivent se trouver dans une zone de sécurité de 300 mm autour de la centrifugeuse selon EN / IEC 61010-2-020.**
- **Les rotors, balanciers et accessoires qui présentent d'importantes traces de corrosion ou des défauts mécaniques ou dont la durée d'utilisation a expiré ne doivent plus être utilisés.**
- **Suspendre immédiatement l'utilisation de la centrifugeuse si la cuve de centrifugeuse présente des dommages susceptibles de porter atteinte à la sécurité.**
- **Les goupilles de fixation des rotors à amortissement doivent être graissées régulièrement (graisse de lubrification Hettich n° 4051) de manière à assurer le balancement régulier de la suspension.**
- **Concernant les centrifugeuses sans réglage de température, il peut y avoir un réchauffement dans la cuve de centrifugeuse en cas de température ambiante élevée et/ou d'utilisation fréquente de l'appareil. Il n'est donc pas possible d'exclure une modification de l'échantillon due à la température.**

- **Il importe de lire et de respecter le mode d'emploi avant la mise en service de la centrifugeuse. Seules les personnes ayant lu et compris le mode d'emploi sont autorisées à manipuler l'appareil.**
- Outre le mode d'emploi et les réglementations contraignantes relatives à la prévention des accidents, il importe également de respecter les règles spécifiques et communément admises en matière de sécurité et de travail. Le mode d'emploi doit être complété des dispositions nationales applicables à la prévention des accidents et à la protection de l'environnement.
- La centrifugeuse a été construite conformément à l'état actuel de la technique et son fonctionnement est sûr. Elle peut cependant présenter des dangers pour l'utilisateur ou des tiers si son utilisation n'est pas confiée à un personnel dûment formé, est inadéquate ou non conforme à sa destination.
- Pendant le fonctionnement, la centrifugeuse ne devra pas être déplacée ou être heurtée.
- En cas de défaillance ou en cas de déverrouillage d'urgence, ne jamais intervenir dans l'appareil lorsque le rotor tourne.
- Afin d'éviter les dommages causés par la condensation en passant d'un local froid à un local chaud, il faut soit réchauffer la centrifugeuse en la laissant pendant au moins 3 heures dans le local chaud avant de la raccorder au secteur, soit la faire fonctionner pendant 30 minutes dans le local froid pour la chauffer.
- Pour cet appareil, vous ne devez utiliser que des rotors et des accessoires homologués par le fabricant (voir chapitre "Anhang/Appendix, Rotoren und Zubehör/Rotors and accessories"). Avant d'utiliser des récipients de centrifugation qui ne sont pas présentés dans le chapitre "Annexe/Appendix, rotors et accessoire/Rotors and accessories", l'utilisateur doit s'assurer auprès du fabricant qu'il peut les utiliser.
- Le rotor de la centrifugeuse doit uniquement être chargé conformément au chapitre "Chargement du rotor".
- Dans le cas de la centrifugation à la vitesse maximale, la densité des substances et des mélanges de substances ne doit pas excéder 1,2 kg/dm<sup>3</sup>.
- Il est interdit de procéder à des centrifugations en présence de défauts d'équilibrage.
- La centrifugeuse ne doit pas être exploitée dans un environnement explosif.
- Il est interdit de procéder à des centrifugations :
  - avec des matières inflammables ou explosives,
  - avec des matières susceptibles de réagir chimiquement ou de dégager d'importantes quantités d'énergie.

- En cas de centrifugation de substances dangereuses ou de substances mixtes toxiques, radioactives ou contaminées par des micro-organismes pathogènes, il incombe à l'utilisateur de prendre les mesures ad hoc.  
Il faut systématiquement utiliser des récipients de centrifugation avec des bouchons spéciaux à vis destinés aux substances dangereuses. Dans le cas des substances des groupes de risques 3 et 4, il faut utiliser un système de sécurité biologique en plus des récipients de centrifugation pouvant être obturés (voir le manuel "Laboratory Biosafety Manual" publié par l'Organisation Mondiale de la Santé).  
Dans un système de sécurité biologique, un joint biologique (bague d'étanchéité) empêche la fuite de gouttelettes et d'aérosols.  
Lorsque la suspension d'un système de sécurité biologique est utilisée sans couvercle, il faut enlever la bague d'étanchéité de la suspension pour éviter de l'endommager pendant le cycle de centrifugation. Les bagues endommagées ne doivent plus être utilisées pour assurer l'étanchéité le système de sécurité biologique.  
En l'absence d'un système de sécurité biologique, une centrifugeuse n'est pas étanche du point de vue microbiologique au sens de la norme EN / IEC 61010-2-020.  
Lors de la fermeture d'un système de sécurité biologique, il faut se conformer aux instructions du chapitre "Fermeture des systèmes de sécurité biologique".  
Pour ce qui concerne les systèmes à sécurité biologique, voir le chapitre "Anhang/Appendix, Rotoren und Zubehör/Rotors and accessories". Dans le doute vous pouvez obtenir les informations auprès du fabricant.
- Il est interdit de centrifuger des matières fortement corrosives pouvant réduire la résistance mécanique des rotors, des supports et des accessoires.
- Les réparations ne peuvent être effectuées que par une personne autorisée à cet effet par le fabricant.
- Utiliser uniquement les pièces de rechange originales et les accessoires d'origine homologués par les Etablissements Andreas Hettich GmbH & Co. KG.
- Les dispositions de sécurité suivantes font foi :  
EN / IEC 61010-1 et EN / IEC 61010-2-020 ainsi que les dérogations nationales.
- La sécurité et la fiabilité de la centrifugeuse seront uniquement garanties si :
  - la centrifugeuse est utilisée conformément aux instructions du mode d'emploi,
  - l'installation électrique du site de la centrifugeuse est conforme aux prescriptions EN / IEC,
  - les contrôles prescrits dans les différents pays en matière de sécurité de l'appareil, par ex. en Allemagne selon BGV A1 et BGR 500 sont effectués par un professionnel.

## 5 Signification des symboles



Symbole sur l'appareil :  
Attention, zone de danger général.  
Avant utilisation de l'appareil, il est indispensable de lire le mode d'emploi et de respecter les consignes relatives à la sécurité!



Symbole dans ce document:  
Attention, zone de danger général.  
Ce symbole indique des consignes de sécurité et signale des situations pouvant être sources de danger.  
Le non-respect de ces instructions peut entraîner des dégâts matériels et personnels.



Symbole sur l'appareil et dans ce document:  
Avertissement de menace biologique pour l'environnement.



Symbole sur l'appareil et dans ce document:  
Faire attention aux surfaces chaudes.  
La non observance de ces indications peut conduire à des dommages matériels et corporels.



Symbole sur l'appareil:  
Équipotential : connecteur à fiche (connecteur L.E.P.) pour la liaison équipotentielle (uniquement pour une centrifugeuse avec un connecteur L.E.P.).



Symbole sur l'appareil:  
Positions de commutation de l'interrupteur à clé.



Symbole dans ce document:  
Ce symbole signale des informations importantes.



Symbole sur l'appareil et dans ce document:  
Symbole pour la collecte séparée des appareils électriques et électroniques, conformément à la directive 2002/96(EG (WEEE). L'appareil fait partie du groupe 8 (appareils de médecine).  
Utilisation dans les pays de l'Union Européenne ainsi qu'en Norvège et en Suisse.

## 6 Composition de la livraison

- 4 Amortisseurs antivibrations
- 1 Clé à fourche double 17/19 mm
- 1 Clé hexagonale
- 1 Graisse pour tourillon porteur
- 1 Mode d'emploi
- 3 Program-data sheet
- 1 Fiche conseil pour l'emballage
- 1 Fiche conseil pour l'installation

Le(s) rotor(s) et accessoires correspondant sont livrés selon les spécifications de la commande.



## 7 Déballer et mettre la centrifugeuse en place

Déballer et mettre la centrifugeuse en place conformément aux notices AH5005XX et AH5005-01XX jointes.

## 8 Mise en service

- Selon la norme sur les appareils de laboratoire EN / IEC 61010-2-020, l'installation locale doit être équipée d'un interrupteur d'arrêt d'urgence pour sectionner l'alimentation du secteur en cas de défaut. Cet interrupteur doit être éloigné de la centrifugeuse, de préférence hors de la pièce dans laquelle est la centrifugeuse ou près de la porte.
- Selon la norme sur les appareils de laboratoire IEC 61010-1, l'installation électrique du bâtiment doit comporter un interrupteur conforme à la norme IEC 60947-5-3 pour séparer l'alimentation du secteur de l'appareil. Cet interrupteur doit se trouver à proximité de l'appareil, être facilement accessible à l'utilisateur et être marqué en tant qu'interrupteur de sécurité pour cet appareil. L'interrupteur doit également pouvoir être verrouillé pour empêcher une remise en marche non intentionnelle.
- Les modèles 5005-90, 5005-08, 5005-88 et 5005-98 sont des appareils reliés de manière rigide.
- Les modèles 5005-80, 5005-90, 5005-08, 5005-88 et 5005-98 doivent uniquement être installés par du personnel autorisé et qualifié.



Ces appareils doivent être installés conformément aux consignes de mise en place et d'installation AH5005-02EN ci-jointes.

- **Placer la centrifugeuse sur un emplacement approprié de manière à ce qu'elle soit stable et mettre de niveau. Lors de la mise en place, il faut respecter la zone de sécurité exigée de 300mm autour de la centrifugeuse selon EN / IEC 61010-2-020.**



**Durant un processus de centrifugation, aucune personne, matière dangereuse et aucun objet ne doivent se trouver dans une zone de sécurité de 300 mm autour de la centrifugeuse selon EN / IEC 61010-2-020.**





- Ne pas placer d'objet devant la grille de ventilation.  
Ménager un espace de ventilation de 300 mm autour de la grille.
- Centrifugeuse avec un connecteur L.E.P. :  
relier en cas de besoin le connecteur L.E.P. au dos de l'appareil à un système médical de liaison équipotentielle supplémentaire.
- Vérifier que la tension de secteur est identique à la mention de la plaque signalétique.
- Pour les modèles 5005, 5005-50, 5005-80 et SK 48.06-30 :  
Raccorder la centrifugeuse à une prise de secteur normalisée au moyen du câble de connexion. Puissance connectée voir chapitre "Données techniques".
- Mettre l'interrupteur d'alimentation de l'installation électrique du bâtiment en marche.
- Allumer l'interrupteur situé sur le revêtement frontal. Amener l'interrupteur en position "I".  
Messages sur l'afficheur :  
1. Modèle de centrifugeuse, 2. Le dernier code de rotor identifié par la fonction d'identification de rotor et la vitesse de rotation maximale du rotor (n-max-Rotor), 3. Version de programme, 4. **OPEN** **OEFFNEN**.
- Ouvrir le capot.  
Les données de centrifuge du dernier programme utilisé ou du programme 1 s'affichent.

## 9 Ouvrir et fermer le couvercle

### 9.1 Ouvrir le couvercle





Le capot ne peut être ouvert que lorsque la centrifugeuse est sous tension et que le rotor est à l'arrêt. Dans les autres cas, voir le chapitre, "Déverrouillage d'urgence".

- Appuyer sur la touche  sur le panneau frontal. Le couvercle est déverrouillé par le moteur, l'éclairage de la touche  s'éteint et le symbole de l'affichage  devient le symbole .

### 9.2 Fermer le couvercle



Ne pas mettre les doigts entre le couvercle et le boîtier.  
Ne pas laisser tomber le couvercle pour le fermer.

- Poser le couvercle dessus et le pousser légèrement vers le bas par la poignée en tube. Le verrouillage est automatique. La touche  s'allume et sur l'afficheur, l'icône  bascule sur l'icône .

## 10 Montage et démontage du rotor

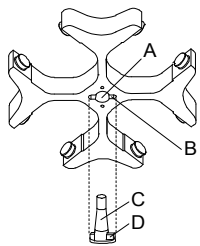

- Nettoyer l'arbre d'entraînement (C) et l'alésage du rotor (A) et enduire ensuite l'arbre d'entraînement d'une pellicule de graisse. Les particules d'impuretés entre l'arbre d'entraînement et le rotor réduisent la stabilité d'assise du rotor et provoquent un fonctionnement irrégulier.
- Enficher le rotor à la verticale sur l'arbre d'entraînement. Le taquet de l'arbre d'entraînement (D) doit être logé dans la rainure du rotor (B). L'orientation de la rainure est indiquée sur le rotor.
- Serrer l'écrou de fixation du rotor avec la clé de la livraison en tournant dans le sens horloger.
- Vérifier la stabilité d'assise du rotor.
- Démontage du rotor: Desserrer l'écrou de fixation par rotation dans le sens anti-horloger jusqu'à ce que le rotor puisse être détaché par pression. En exerçant une légère pression, détacher le rotor du cône de l'arbre d'entraînement. Dévisser l'écrou de fixation jusqu'à ce que le rotor soit détaché de l'arbre d'entraînement.

## 11 Chargement du rotor



Des récipients standard de centrifugation en verre sont résistants jusqu' à un ACR de 4000 (DIN 58970, partie 2).

- Vérifier la stabilité d'assise du rotor.
- Dans le cas des rotors à balanciers, toutes les positions des rotors doivent être équipées avec les **mêmes** balanciers. Certains balanciers sont désignés avec le numéro de la place du rotor. Ces balanciers doivent exclusivement être installés dans la place de rotor correspondante. Les balanciers désignés par un numéro de set, comme S001/4 par exemple, doivent exclusivement être utilisés dans le set.
- Le chargement des rotors et des balanciers doit être nécessairement symétrique. Les conteneurs de centrifugation doivent être uniformément répartis sur toutes les positions du rotor. Pour les combinaisons possibles, voir le Chapitre "Anhang/Appendix, Rotoren und Zubehör/Rotors and accessories". Dans le cas des rotors à angle fixe, il faut charger tous les logements possibles du rotor, voir au chapitre "Annexe/Appendix, Rotors et accessoires/Rotors and accessories".

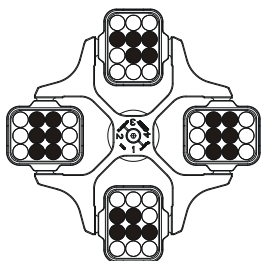

Rotor uniformément chargé

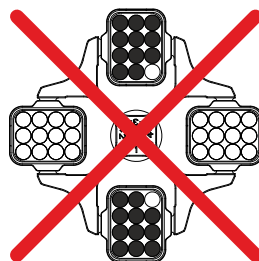

**Non autorisé !**

Rotor irrégulièrement chargé

- Certains dispositifs de suspension indiquent soit le poids maximum de la charge, soit le poids total maximum comprenant charge et dispositifs. Pour les cas d'exception, voir le chapitre "Centrifugation de matières et de mélanges d'une densité supérieure à 1,2 kg/dm<sup>3</sup>". L'indication du poids de la charge maximale comprend le poids total de la réduction, châssis, récipient de centrifugation et contenu.
- Dans le cas des récipients à garniture de caoutchouc, les récipients de centrifugation doivent avoir le même nombre de garnitures dans la partie inférieure.
- Remplissez les réservoirs de centrifugation uniquement en dehors de la centrifugeuse.
- La quantité maximale de remplissage indiquée par le fabricant pour les récipients de centrifugation ne doit pas être dépassée.

Pour les rotors angulaires, remplir les réservoirs de centrifugation de sorte que du liquide ne puisse pas être projeté à l'extérieur pendant le cycle de centrifugation

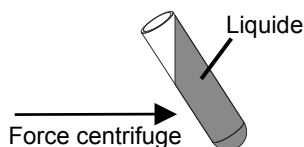

- Aucun fluide ne doit pénétrer dans les rotors angulaires et dans la cuve de centrifugeuse lors du chargement des rotors angulaires.
- Pendant le chargement de la suspension des balanciers, et pendant le balancement de la suspension dans le cycle de centrifugation, aucun fluide ne doit pénétrer dans la cuve de centrifugeuse..
- La hauteur de remplissage des récipients sera autant que possible égale pour maintenir les différences de poids entre les récipients de centrifugation aussi réduites que possible .

## 12 Fermeture des systèmes de sécurité biologique



Pour garantir l'étanchéité, le couvercle d'un système de sécurité biologique doit être solidement fermé.

Pour éviter de fausser la bague d'étanchéité en ouvrant et en fermant le couvercle, il faut frotter légèrement la bague d'étanchéité avec de la poudre de talc ou un produit d'entretien pour caoutchouc.

Pour ce qui concerne les systèmes à sécurité biologique, voir le chapitre "Anhang/Appendix, Rotoren und Zubehör/Rotors and accessories". Dans le doute vous pouvez obtenir les informations auprès du fabricant.

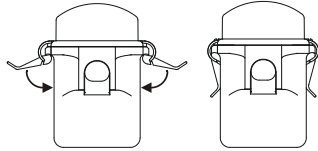

Couvercle avec fermeture à genouillère

- Placer le couvercle sur le balancier et rabattre les deux genouillères vers le bas jusqu'à ce qu'elles se trouvent sous les éclisses du balancier.
- Rabattre les deux genouillères à fond vers le bas. Elles doivent être au contact du balancier.

## 13 Éléments de commande et d'affichage

Voir illustration sur la page 2.

Fig. 2 : Zone de commande et d'affichage

### 13.1 Symboles d'état



Couvercle ouvert.



Couvercle fermé.



Affichage de la rotation. L'affichage apparaît durant le processus de centrifugation, tant que le rotor tourne.

**STOP**

Processus de centrifugation arrêté ou terminé. L'affichage apparaît une fois le processus de centrifugation clôturé, tant que le rotor tourne. Suite à un arrêt d'urgence, l'affichage clignote.

**LOCK 1,  
LOCK 2**

Position enclenchée de l'interrupteur à clé.

**LOCK 4,  
LOCK 5**

Verrouillage du programme en cas de communication série (uniquement dans le cas de centrifugeuses avec communication série).

**PC, PE**

Communication série (uniquement dans le cas de centrifugeuses avec communication série).

Les erreurs de commande ou les incidents sont symbolisés à l'écran (se reporter au chapitre "Défauts").

### 13.2 Bouton de réglage



Pour le réglage des paramètres individuels.

Pour faire décroître la valeur, tourner le bouton dans le sens anti-horaire. Pour augmenter la valeur, tourner le bouton dans le sens horaire.

### 13.3 Touches et possibilités de réglage



Durée de fonctionnement, paramètres t/min:sec

1. Paramètres t/min: réglables de 1 à 999 min, par intervalles d'1 minute.
2. Paramètres t':sec réglables de 1 à 59 s, par intervalles d'1 seconde.
3. Fonctionnement en continu"---:--"



Interrogation de l'Integral RCF, paramètre fRCF.



1. Vitesse de rotation, paramètre RPM

Il est possible de régler une valeur numérique comprise entre 50 RPM et la vitesse de rotation maximale du rotor (n-max-Rotor). Pour la vitesse maximale de rotation du rotor, se reporter au chapitre "Anhang/Appendix, Rotoren und Zubehör/Rotors and accessories". Réglable par intervalles de 10.

2. Interrogation de la vitesse maximale de rotation du rotor, paramètres n-max-Rotor.



1. Accélération de centrifugation relative, paramètres RCF/RZB  
Il est possible de régler une valeur numérique dont découle une vitesse de rotation située entre 50 RPM et la vitesse maximale de rotation du rotor (n-max-Rotor). Réglable par intervalles de 1.
2. Interrogation du RCF maximal du rotor, paramètres RCF-max-Rotor.



- Paramètres de démarrage
1. Niveaux de démarrage, paramètres  $\curvearrowright$ .1-9. Niveau 9 = temps de démarrage le plus court, ... Niveau 1 = temps de démarrage le plus long.
  2. Temps de démarrage, paramètres  $\curvearrowright$ .min:sec. L'intervalle de temps pouvant être réglé dépend de la vitesse de rotation paramétrée.



- Paramètres de rotation par inertie
1. Niveaux de freinage, paramètres  $\curvearrowleft$ .0-9. R = courbe de freinage linéaire, B = comparable à une courbe de freinage exponentielle. Niveau R9, B9 = temps de rotation par inertie de courte durée, ... niveau R1, B1 = temps de rotation par inertie de longue durée, niveau R0 = rotation par inertie non freinée.
  2. Temps de rotation par inertie, paramètres  $\curvearrowleft$ .min:sec. L'intervalle de temps pouvant être réglé dépend de la vitesse de rotation paramétrée.
  3. Nombre de tours de l'arrêt de freinage, paramètres n<sup>(\*)</sup>/RPM  
Dès que ce nombre de tours est atteint, la rotation par inertie n'est plus freinée.



1. Valeur nominale de la température, paramètres T/°C. Réglable de -20°C à +40°C, par intervalles de 1°C (réglable de -20°C à +90°C avec l'option Chauffer/refroidir). La température la plus basse pouvant être atteinte dépend du rotor (se reporter au chapitre "Anhang/Appendix, Rotoren und Zubehör/Rotors and accessories").
2. Rayon de centrifugation, paramètres r/mm. Introduction en mm. Pour le rayon de centrifugation, se reporter au chapitre "Anhang/Appendix, Rotoren und Zubehör/Rotors and accessories".

START

1. Démarrer le processus de centrifugation. Affichage de la rotation  $\odot$ .
2. Validation de modifications durant le processus de centrifugation.

STOP

Terminer le processus de centrifugation.  
Rotation par inertie du rotor selon les paramètres de rotation par inertie présélectionnés. Le fait d'appuyer deux fois sur la touche déclenche l'arrêt d'urgence.

PROG

Sélectionner la position de programme, paramètres PROG-Nr.

RCL

Récupération de programmes.

STO

Mise en mémoire de programmes.  
Il est possible d'enregistrer 89 programmes (positions de programmes 1 à 89). Remarque : les positions de programmes "----" et 90 à 99 servent de mémoire tampon automatique (se reporter au chapitre "Mémoire tampon automatique"). Il est impossible d'enregistrer des programmes à ces positions.

## 14 Saisie des paramètres de centrifugation



La saisie d'un paramètre est uniquement possible lorsque le champ de saisie « inversé » est affiché (arrière-plan de couleur sombre). Un champ de saisie « inversé » disparaît automatiquement, au bout de 10 secondes.

### 14.1 Durée de fonctionnement

#### 14.1.1 Présélection de la durée

- Appuyer sur la touche  $\square$  autant de fois que nécessaire, jusqu'à ce que le paramètre t/min: ou t/:sec s'affiche. Le champ de saisie affiché est « inversé ».
- Avec le bouton de réglage  $\odot$ , paramétrer la valeur recherchée.

#### 14.1.2 Fonctionnement en continu

- Sélectionner les paramètres t/min: et t/:sec les uns à la suite des autres (se reporter au chapitre "Présélection de la durée"), et les régler tous deux sur zéro, au moyen du bouton de réglage  $\odot$ . "----:--" s'affiche dans le champ de saisie.

### 14.2 Vitesse de rotation (RPM)

- Appuyer sur la touche  $\square$  autant de fois que nécessaire, jusqu'à ce que le paramètre RPM s'affiche et que le champ de saisie « inversé » apparaisse.
- Avec le bouton de réglage  $\odot$ , paramétrer la valeur recherchée.

### 14.3 Accélération relative de centrifugation (RCF/RZB)

- Appuyer sur la touche  $\boxed{\text{RCF}}$  autant de fois que nécessaire, jusqu'à ce que le paramètre RCF/RZB s'affiche et que le champ de saisie « inversé » apparaisse.
- Avec le bouton de réglage  $\odot$ , paramétrer la valeur recherchée.

Lors du paramétrage, l'affichage du rayon de centrifugation clignote.

### 14.4 Paramètres de démarrage et paramètres de rotation par inertie

Les paramètres de démarrage et les paramètres de rotation par inertie réglés s'affichent.



x: 1-9 = temps de démarrage, t = temps de démarrage

y: R1-R9, B1-B9 = niveau de freinage, R0 = rotation par inertie non freiné, t = temps de rotation par inertie, n<sup>(\*)</sup> = nombre de tours de l'arrêt de freinage

#### 14.4.1 Niveau de démarrage

- Appuyer sur la touche  $\boxed{\text{1-9}}$  autant de fois que nécessaire, jusqu'à ce que le paramètre  $\text{1-9}$  ou  $\text{1-9}$  s'affiche. Le champ de saisie affiché est « inversé ».
- A l'aide du bouton de réglage  $\odot$ , paramétrer le niveau recherché.

#### 14.4.2 Temps de démarrage

- Appuyer sur la touche  $\boxed{\text{min:sec}}$  autant de fois que nécessaire, jusqu'à ce que le paramètre  $\text{min:sec}$  s'affiche. Le champ de saisie affiché est « inversé ».
- Avec le bouton de réglage  $\odot$ , paramétrer la valeur recherchée.

Si le temps de démarrage paramétré est supérieur à la durée de fonctionnement, le processus de centrifugation se termine avant que le nombre de tours paramétré soit atteint.

#### 14.4.3 Niveau de freinage

- Appuyer sur la touche  $\boxed{\text{0-9}}$  autant de fois que nécessaire, jusqu'à ce que le paramètre  $\text{0-9}$  ou  $\text{0-9}$  s'affiche. Le champ de saisie affiché est « inversé ».
- A l'aide du bouton de réglage  $\odot$ , paramétrer le niveau recherché.

Les niveaux de freinage B peuvent uniquement être paramétrés pour des rotors spéciaux.

#### 14.4.4 Temps de rotation par inertie

En cas de paramétrage d'un nombre de tours d'arrêt de freinage, il est impossible de paramétrer le temps de rotation par inertie.

- Appuyer sur la touche  $\boxed{\text{min:sec}}$  autant de fois que nécessaire, jusqu'à ce que le paramètre  $\text{min:sec}$  s'affiche. Le champ de saisie affiché est « inversé ».
- Avec le bouton de réglage  $\odot$ , paramétrer la valeur recherchée.

#### 14.4.5 Nombre de tours de l'arrêt de freinage

- Appuyer sur la touche  $\boxed{\text{RPM}}$  autant de fois que nécessaire, jusqu'à ce que le paramètre n<sup>(\*)</sup>/RPM s'affiche. Le champ de saisie affiché est « inversé ».
- Avec le bouton de réglage  $\odot$ , paramétrer la valeur recherchée.

### 14.5 Rayon/température

#### 14.5.1 Rayon

- Appuyer sur la touche  $\boxed{\text{r/mm}}$  autant de fois que nécessaire, jusqu'à ce que le paramètre r/mm s'affiche et que le champ de saisie « inversé » apparaisse.
- Avec le bouton de réglage  $\odot$ , paramétrer la valeur recherchée.

En cas de modification du rayon, le programme ajuste automatiquement la valeur RCF/RZB et le signale par un affichage clignotant.

#### 14.5.2 Température

- Appuyer sur la touche  $\boxed{\text{T/°C}}$  autant de fois que nécessaire, jusqu'à ce que le paramètre T/°C s'affiche et que le champ de saisie « inversé » apparaisse.
- Avec le bouton de réglage  $\odot$ , paramétrer la valeur recherchée.

## 14.6 Mémoire tampon automatique

La mémoire tampon comprend les positions de programmes "----" et 90 à 99. Après chaque lancement d'un processus de centrifugation, les données de centrifugation modifiées sont automatiquement enregistrées à la position de programme "----". Les données de centrifugation modifiées des 11 derniers processus de centrifugation sont enregistrées dans la mémoire tampon et peuvent être extraites (se reporter au chapitre "Récupération de programme").

## 15 Programmation

### 15.1 Introduction de programme / modification de programme

- Régler les paramètres recherchés (se reporter au chapitre "Saisie des paramètres de centrifugation").
- Appuyer sur la touche **PROG**, pour sélectionner le paramètre PROG-Nr. Le champ de saisie affiché est « inversé ».
- Avec le bouton de réglage **○**, paramétrer la position de programme recherchée. L'affichage clignotant de la position de programme indique que cette position est déjà occupée par des données de centrifugation. Dans ce cas, paramétrer une position de programme libre ou écraser les données de centrifugation en poursuivant la procédure.
- Appuyer 1x sur la touche **STO**, pour enregistrer les paramètres à la position de programme recherchée. Appuyer 2x sur la touche **STO**, pour écraser des données de centrifugation enregistrées.

### 15.2 Récupération de programme

- Appuyer sur la touche **PROG**, pour sélectionner le paramètre PROG-Nr. Le champ de saisie affiché est « inversé ».
- Avec le bouton de réglage **○**, paramétrer la position de programme recherchée.
- Appuyer sur la touche **RCL**. Les données de centrifugation de la position de programme sélectionnée s'affichent.

## 16 Centrifugation



Durant un processus de centrifugation, aucune personne, matière dangereuse et aucun objet ne doivent se trouver dans une zone de sécurité de 300 mm autour de la centrifugeuse selon EN / IEC 61010-2-020.



L'entraînement est stoppé en phase de montée en puissance si la différence de tare admissible a été dépassée pendant le chargement du rotor, et la mention **IMBALANCE / UNWUCHT** est affichée.

Si la vitesse de rotation du programme sélectionné est supérieure à la vitesse de rotation maximale du rotor (n-max-Rotor), aucun processus de centrifugation ne peut être lancé. Le programme affiche **N > ROTOR MAX 96** (se reporter au chapitre "Défauts").

La centrifugation peut être stoppée n'importe quand en appuyant sur la touche **STOP**.

Les touches **R** et **RCF** permettent de commuter à tout moment entre les affichages RPM et RCF. Lorsque le travail est effectué avec l'affichage RCF, il est impératif d'entrer le rayon de centrifugation.

Après affichage de **OPEN / OEFFNEN** (= OUVRIER) la commande de centrifugeuse n'est possible qu'après avoir ouvert le couvercle une fois.

Si **R xx n-max xxxxx** est affiché, la marche de centrifugation n'a pas été exécutée en raison du changement du rotor, voir chapitre "Identification de rotor".

- Activer l'interrupteur secteur. Position de l'interrupteur **I**.
- Charger le rotor et fermer le couvercle de la centrifugeuse.

### 16.1 Centrifugation avec présélection de la durée

- Paramétrer la durée ou appeler un programme avec présélection de la durée (se reporter au chapitre "Saisie des paramètres de centrifugation" ou "Récupération de programme").
- Appuyer sur la touche **START**. Le symbole de rotation **⦿** est affiché tant que le rotor tourne.
- Une fois le temps écoulé ou en cas d'interruption du processus de centrifugation par actionnement de la touche **STOP**, la rotation par inertie est exécutée selon les paramètres de rotation par inertie sélectionnés. Dès que le rotor s'est immobilisé, le symbole **⏸** clignote à l'écran, jusqu'à ce que le couvercle soit ouvert.

Durant le processus de centrifugation, la vitesse de rotation du rotor ou la valeur RCF en résultant, ainsi que la température des échantillons et le temps restant, sont affichés.

## 16.2 Fonctionnement en continu

- Paramétrer le symbole ---:-- ou appeler un programme de fonctionnement en continu (se reporter au chapitre "Saisie des paramètres de centrifugation" ou "Récupération de programme").
- Appuyer sur la touche **START**. Le symbole de rotation  $\odot$  est affiché tant que le rotor tourne. Le décompte du temps commence à 00:00.
- Appuyer sur la touche **STOP**, afin de clôturer le processus de centrifugation. La rotation par inertie est exécutée selon les paramètres de rotation par inertie sélectionnés. Dès que le rotor s'est immobilisé, le symbole  $\square$  clignote à l'écran, jusqu'à ce que le couvercle soit ouvert.

Durant le processus de centrifugation, la vitesse de rotation du rotor ou la valeur RCF en résultant, ainsi que la température des échantillons et le temps écoulé, sont affichés.

## 17 Modifier des réglages pendant le processus de centrifugation

La durée de fonctionnement, la vitesse de rotation, l'accélération relative de centrifugation (RCF/RZB), les paramètres de démarrage et de rotation par inertie, ainsi que la température peuvent être modifiés pendant le processus de centrifugation.

Il est possible de modifier les paramètres uniquement individuellement et les uns à la suite des autres.

- Sélectionner le paramètre recherché et modifier la valeur au moyen du bouton de réglage  $\odot$  (se reporter au chapitre "Saisie des paramètres de centrifugation").
- Appuyer sur la touche **START**. Le paramétrage modifié est enregistré à la position de programme "----" (se reporter au chapitre "Mémoire tampon automatique"). Le programme d'origine n'est pas écrasé.

## 18 Integral RCF ( $\int$ RCF)

L'Integral RCF ( $\int$ RCF) est une cote pour l'effet de sédimentation ( $\int n^2 dt$ ). Cette valeur numérique permet de comparer les processus de centrifugation. Pour interroger l'Integral RCF, maintenir la touche **RCF** enfoncée.

## 19 Affichage de la vitesse de rotation maximale du rotor

- Appuyer sur la touche  $\square$  autant de fois que nécessaire, jusqu'à ce que le paramètre RPM s'affiche et que le champ de saisie « inversé » apparaisse.
- Appuyer encore 1x sur la touche  $\square$  et la maintenir enfoncée : la vitesse maximale de rotation du rotor (n-max-Rotor) s'affiche.

## 20 Affichage de la valeur RCF maximale du rotor

- Appuyer sur la touche **RCF** autant de fois que nécessaire, jusqu'à ce que le paramètre RCF/RZB s'affiche et que le champ de saisie « inversé » apparaisse.
- Appuyer encore 1x sur la touche **RCF** et la maintenir enfoncée : la valeur RCF maximale du rotor (RCF-max-Rotor) s'affiche.

## 21 Arrêt d'urgence

- Appuyer 2x sur la touche **STOP**. Le symbole **STOP** clignote à l'écran.

En cas d'arrêt d'urgence, la rotation par inertie est exécutée selon le niveau de freinage R9 (temps de rotation par inertie le plus court). Si le niveau de freinage R0 avait été présélectionné, pour des raisons techniques, le temps de rotation par inertie est plus long qu'avec le niveau de freinage R9.



## 22 Signal acoustique

Le signal acoustique retentit suite au réglage suivant :

<b>OFF</b>	<ul style="list-style-type: none"> <li>En cas de panne, par intervalles de 2 secondes.</li> </ul>
<b>ON1</b>	<ul style="list-style-type: none"> <li>En cas de panne, par intervalles de 2 secondes.</li> <li>Suite à la clôture du processus de centrifugation et à l'immobilisation du rotor, par intervalles de 30 secondes.</li> </ul>
<b>ON2</b>	<ul style="list-style-type: none"> <li>En cas de panne, par intervalles de 2 secondes.</li> <li>Suite à la clôture du processus de centrifugation et à l'immobilisation du rotor, par intervalles de 30 secondes.</li> <li>A chaque actionnement de touche.</li> </ul>



Le fait d'ouvrir le couvercle ou d'appuyer sur n'importe quelle touche annule le signal acoustique.

Lorsque le rotor est immobile, il est possible de régler le signal acoustique de la manière suivante :

- Ouvrir le couvercle.
- Maintenir la touche  enfoncée pendant 8 secondes.  
Au bout de 8 secondes, le programme affiche **SOUND / BELL XXX**.
- Au moyen du bouton de réglage , paramétrer la fonction désirée (OFF, ON1, ON2).
- Appuyer sur la touche , pour enregistrer le paramétrage.  
Le programme affiche brièvement **\*\*\* ok \*\*\***, à titre de confirmation.









## 23 Interrogation relative au nombre d'heures de service

Il est uniquement possible de lancer l'interrogation quant au nombre d'heures de service lorsque le rotor est immobile.

- Ouvrir le couvercle.
- Maintenir la touche  enfoncée pendant 8 secondes.  
Au bout de 8 secondes, le programme affiche **SOUND / BELL XXX**.
- Appuyer encore 1x sur la touche .
- Les heures de service (**CONTROL:** ) de la centrifugeuse, s'affichent.  
L'affichage des heures de service disparaît automatiquement au bout de 10 secondes.



## 24 Réglage de la date et de l'heure

Il est uniquement possible de régler la date et l'heure lorsque le rotor est immobile.

- Ouvrir le couvercle.
- Maintenir la touche  enfoncée pendant 8 secondes.  
Au bout de 8 secondes, le programme affiche **SOUND / BELL XXX**.
- Appuyer encore 2x sur la touche .
- La date et l'heure s'affichent (a: année, mon: mois, d: jour, h: heure, min: minutes).
- Appuyer sur la touche  autant de fois que nécessaire, jusqu'à ce que le champ de saisie du paramètre recherché s'affiche de façon « inversée ».
- Avec le bouton de réglage , paramétrer la valeur recherchée.
- Appuyer sur la touche , pour enregistrer le paramétrage.  
Le programme affiche brièvement **\*\*\* ok \*\*\***, à titre de confirmation.
- Pour quitter le paramétrage de la date et de l'heure, appuyer sur n'importe quelle touche, exception faite de les touches ,  et .

## 25 Données de centrifugation, affichées suite à la mise en service

Suite à la mise en service, les données de centrifugation du programme 1 ou du dernier programme utilisé s'affichent. Il est possible de procéder aux réglages suivants :

- Ouvrir le couvercle.
- Désactiver l'interrupteur secteur, puis l'activer de nouveau. Position de l'interrupteur I.
- Dès la première transformation optique visible à l'écran (affichage « inversé »), appuyer sur la touche .
- Le programme affiche **PROGRAM 1, LAST PROGRAM**.
- Au moyen du bouton de réglage , paramétrer la fonction désirée.
- Appuyer sur la touche , pour enregistrer le paramétrage.  
Le programme affiche brièvement **\*\*\* ok \*\*\***, à titre de confirmation.

## 26 Affichage immédiat des données de centrifugation suite à la mise en service

- Activer l'interrupteur secteur. Position de l'interrupteur I.
- Dès la première transformation optique visible à l'écran (affichage « inversé »), appuyer sur n'importe quelle touche, exception faite de la touche . Les données de centrifugation s'affichent instantanément.



## 27 Interrupteur à clé

L'interrupteur à clé permet de paramétrer les verrouillages de programmes suivant :

Position de l'interrupteur vers la gauche :	<b>LOCK 1</b> s'affiche. Les programmes peuvent uniquement être appelés et non pas modifiés.
Position de l'interrupteur vers la droite :	<b>LOCK 2</b> s'affiche. Aucun programme ne peut être appelé ni modifié.
Position de l'interrupteur au centre :	Pas d'affichage d'état. Aucun verrouillage du programme. Il est possible d'appeler les programmes et de les modifier.

## 28 Création de liens entre programmes (uniquement dans le cas de centrifugeuses dotées de la fonction de création de liens entre programmes)

Les liens entre programmes permettent de combiner plusieurs processus de centrifugation entre eux.

### 28.1 Créer des liens entre programmes



Il est uniquement possible de créer des liens entre les programmes pour lesquels les niveaux de démarrage et de freinage ont été paramétrés.

Avant la création des liens, les programmes doivent être enregistrés dans l'ordre chronologique désiré, soit au moyen de la fonction d'introduction de programmes, soit au moyen de la fonction de récupération de programmes (se reporter au chapitre "Programmation").

Les positions de programmes doivent être ordonnées les unes à la suite des autres (par exemple : positions de programmes 10+11+12).

1. Appuyer sur la touche **PROG**, pour sélectionner le paramètre PROG-Nr. Le champ de saisie affiché est « inversé ».
2. Au moyen du bouton de réglage **○**, paramétrer la position du programme initial (XX+).
3. Appuyer sur la touche **RCL**. Les données de centrifugation de la position de programme sélectionnée s'affichent.
4. Appuyer 2x sur la touche **PROG**, pour sélectionner le paramètre PR-PART. Le champ de saisie affiché est « inversé ».
5. Appuyer 2x sur la touche **STO**. Le programme est enchaîné et le numéro de programme de la position suivante (+XX+) s'affiche.
6. Appuyer 2x sur la touche **RCL**. Les données de centrifugation de la position de programme sélectionnée s'affichent.
7. Appuyer 2x sur la touche **STO**. Le programme est enchaîné et le numéro de programme de la position suivante (+XX+) s'affiche.
8. Répéter les étapes 6 et 7 aussi souvent que nécessaire, jusqu'à ce que tous les programmes soient enchaînés.
9. Pour clore la procédure, appuyer sur la touche **PROG**. Le numéro de programme du programme final (+XX) s'affiche.

### 28.2 Modifier les liens entre programmes

- Extraire le programme recherché (se reporter au chapitre "Récupération de programme"), modifier les paramètres désirés (se reporter au chapitre "Saisie des paramètres de centrifugation"), puis enregistrer les données de centrifugation modifiées à la même position de programme (se reporter au chapitre "Introduction de programme / modification de programme"). L'enregistrement annule le lien entre programmes.
- Reconstituer les liens entre les programmes (se reporter au chapitre "Créer des liens entre programmes").

### 28.3 Processus de centrifugation avec lien entre programmes

- Appuyer 2x sur la touche **PROG**, pour sélectionner le paramètre PR-PART. Le champ de saisie affiché est « inversé ».
  - Au moyen du bouton de réglage **○**, paramétrer la position du programme initial (XX+).
  - Appuyer sur la touche **RCL**. Les données de centrifugation de la position de programme sélectionnée s'affichent.
  - Appuyer sur la touche **START**. Le symbole de rotation **⦿** est affiché tant que le rotor tourne.
- Les niveaux de démarrage et de freinage du lien des programmes s'affichent :

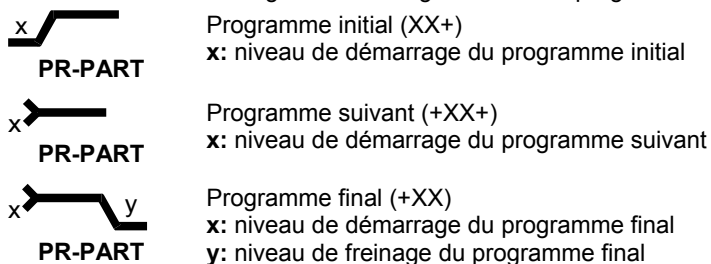

- Dès que le temps paramétré pour le programme final est écoulé, la rotation par inertie est exécutée avec le niveau de freinage du programme final. En cas d'interruption du processus de centrifugation par actionnement de la touche **STOP**, la rotation par inertie est exécutée avec le niveau de freinage du programme courant.

### 28.4 Effacer des liens entre programmes

- Appuyer sur la touche **PROG**, pour afficher le paramètre PROG-Nr. Le champ de saisie affiché est « inversé ».
- Au moyen du bouton de réglage **○**, paramétrer la position du programme initial (XX+).
- Appuyer sur la touche **RCL**. Les données de centrifugation de la position de programme sélectionnée s'affichent.
- Appuyer 2x sur la touche **PROG**, pour afficher le paramètre PR-PART. Le champ de saisie affiché est « inversé ».
- Appuyer 2x sur la touche **STO**.
- Appuyer sur la touche **PROG**.

## 29 Refroidissement (uniquement sur centrifugeuse avec refroidissement)

La température de consigne peut être réglée sur une plage de -20 °C à +40 °C. Pour les centrifugeuses équipées de l'option Chauffer/refroidir, la valeur prescrite de la température est réglable de -20°C à +90°C. Le minimum de température possible est fonction du rotor (voir le Chapitre "Anhang/Appendix, Rotoren und Zubehör/Rotors and accessories"). Si la différence entre la température actuelle et la température de consigne dépasse 5°C, ceci est signalée par un clignotement de l'affichage de température.

### 29.1 Refroidissement en veilleuse

A l'arrêt du rotor et lorsque le couvercle est fermé, le bol de centrifugeuse est refroidi à la température sélectionnée. La température de consigne est indiquée sur l'afficheur.

### 29.2 Pré-refroidissement du rotor

Afin de garantir une prérefrigération rapide du rotor à l'état non chargé et des accessoires utilisés, il est recommandé de sélectionner un processus de centrifugation avec les paramétrages du fonctionnement en continu et une vitesse de rotation d'environ 20% de la vitesse de rotation maximale du rotor.

## 30 Chauffage (uniquement sur centrifugeuse avec l'option Chauffer/refroidir)

Au cours du fonctionnement de centrifugation, en cas de besoin, la zone de centrifugation peut être chauffée à une température pré-sélectionnée. Lorsque le rotor est au point mort, le chauffage est éteint.



Risque de brûlure ! La température de surface de l'élément chauffant dans le compartiment de centrifugation de la centrifugeuse peut monter jusqu'à 500 °C / 932 °F. Ne pas toucher l'élément chauffant. Au cours d'un cycle de centrifugation avec une température très élevée (par ex. +90°C), le côté intérieur du couvercle de l'appareil chauffe. Dans ce cas, ne toucher pas au côté intérieur du couvercle.

### 31 Accélération centrifuge relative (RCF)

L'accélération centrifuge relative (RCF) est indiquée en tant que multiple de l'accélération gravitationnelle (g). Il s'agit d'une valeur dépourvue d'unité, qui sert à la comparaison entre la puissance de séparation et de sédimentation.

Le calcul s'effectue à l'aide de la formule suivante:

$$\text{RCF} = \left( \frac{\text{RPM}}{1000} \right)^2 \times r \times 1,118 \quad \Rightarrow \quad \text{RPM} = \sqrt{\frac{\text{RCF}}{r \times 1,118}} \times 1000$$

RCF = accélération centrifuge relative

RPM = régime

r = rayon de centrifugation en mm = distance qui sépare le centre de l'axe de rotation du fond de la cuve de centrifugation. Rayon de centrifugation voir chapitre "Anhang/Appendix, Rotoren und Zubehör/Rotors and accessories".



L'accélération centrifuge relative (RCF) est dépendante du régime et du rayon de centrifugation.

### 32 Centrifugation de matières et de mélanges d'une densité supérieure à 1,2 kg/dm<sup>3</sup>

Dans le cas de la centrifugation à la vitesse maximale, la densité des substances et des mélanges de substances ne doit pas excéder 1,2 kg/dm<sup>3</sup>. Réduire la vitesse de rotation pour les matières et mélanges ayant une densité supérieure.

La vitesse de rotation autorisée se calcule de la manière suivante:

$$\text{Vitesse de centrifugation lente (n}_{\text{red}}) = \sqrt{\frac{1,2}{\text{densité supérieure [kg/dm}^3]}} \times \text{Vitesse de rotation maximum [RPM]}$$

Exemple: Vitesse de rotation maximum RPM 4000, densité 1,6 kg/dm<sup>3</sup>

$$n_{\text{red}} = \sqrt{\frac{1,2 \text{ kg/dm}^3}{1,6 \text{ kg/dm}^3}} \times 4000 \text{ RPM} = 3464 \text{ RPM}$$

Dans le cas exceptionnel de dépassement de la charge maximum indiquée sur la suspension, réduire également la vitesse de rotation.

La vitesse de rotation autorisée se calcule de la manière suivante:

$$\text{Vitesse de centrifugation lente (n}_{\text{red}}) = \sqrt{\frac{\text{Charge maximum [g]}}{\text{Charge réelle [g]}}} \times \text{Vitesse de rotation maximum [RPM]}$$

Exemple: Vitesse de rotation maximum RPM 4000, Charge maximum 300 g, Charge réelle 350 g

$$n_{\text{red}} = \sqrt{\frac{300 \text{ g}}{350 \text{ g}}} \times 4000 \text{ RPM} = 3703 \text{ RPM}$$

En cas d'incertitude, prendre contact avec le fabricant.

### 33 Identification du rotor

Une identification du rotor est effectuée après le démarrage de chaque cycle de centrifugation.

Si le rotor a été remplacé, le cycle de centrifugation s'interrompt après l'identification du rotor. L'afficheur indique le code (R xx) et la vitesse de rotation maximale (n-max=xxxxx) du rotor.



Toute commande ultérieure de la centrifuge n'est possible qu'après une ouverture du couvercle.

Si la vitesse de rotation maximale du rotor utilisé est inférieure à la vitesse de rotation paramétrée, la vitesse de rotation effective est limitée à la vitesse de rotation maximale du rotor.

### 34 Déverrouillage d'urgence

En cas de panne de courant, le couvercle ne peut pas être déverrouillé avec le moteur. Il est nécessaire d'exécuter un déverrouillage manuel.



Avant d'exécuter le déverrouillage manuel, retirer la fiche de l'alimentation. Dans le cas des appareils reliés de manière rigide, éteindre l'interrupteur de secteur pour couper l'alimentation secteur de l'appareil dans l'installation du bâtiment et empêcher une remise en marche, par ex. en verrouillant l'interrupteur.  
Attendre que le rotor est à l'arrêt pour ouvrir le couvercle.

Voir illustration sur la page 2.

- Éteindre l'interrupteur situé sur le revêtement frontal (position de l'interrupteur "0").
- Regarder par la fenêtre située sur le couvercle pour s'assurer que le rotor est immobile.
- Insérer horizontalement la clé mâle coudée à six pans creux dans l'orifice (Fig. 1, A) et tourner avec précaution d'un demi-tour dans le sens des aiguilles d'une montre jusqu'à ce que le couvercle puisse être ouvert.
- Retirer la clé à six pans hors de l'alésage.
- Après avoir remis la centrifugeuse sous tension, appuyer sur la touche  pour ramener le verrouillage de couvercle automatique en position initiale (ouvert).

### 35 Entretien et maintenance



L'appareil est peut-être contaminé.



Retirer la prise de secteur avant de nettoyer. Dans le cas des appareils reliés de manière rigide, éteindre l'interrupteur de secteur pour couper l'alimentation secteur de l'appareil dans l'installation du bâtiment et empêcher une remise en marche, par ex. en verrouillant l'interrupteur.

Avant d'utiliser une procédure de nettoyage ou de décontamination autre que celle recommandée par le fabricant, l'utilisateur vérifiera auprès du fabricant que la procédure prévue n'endommage pas l'appareil.

- Ne pas nettoyer centrifuges, rotors et accessoires dans un lave-vaisselle.
- Seul le nettoyage manuel et une désinfection liquide sont autorisés.
- La température de l'eau doit être située entre 20 et 25°C.
- Utiliser exclusivement des agents de nettoyage ou de désinfection qui :
  - ont un pH de 5 à 8,
  - ne contiennent pas de substances caustiques, de peroxyde, composés chlorés, acides ni alcalins.
- Respecter impérativement les consignes spéciales d'utilisation données par le fabricant des agents de nettoyage et de désinfection, afin de prévenir la corrosion par les agents de nettoyage et de désinfection.

#### 35.1 Centrifugeuse (boîtier, couvercle et cuve)

##### 35.1.1 Entretien et nettoyage des surfaces

- Nettoyer régulièrement le boîtier de la centrifugeuse et le compartiment de centrifugation et les laver en cas de besoin avec du savon ou un détergent doux et un chiffon humide. Ces opérations sont nécessaires pour garantir l'hygiène et pour prévenir la corrosion par la présence durable d'impuretés.
- Substances des nettoyeurs adéquats :  
savon, agents anioniques et non ioniques.
- Après utilisation des nettoyeurs, enlevez les résidus en essuyant l'appareil avec un chiffon humide.
- Séchez immédiatement les surfaces après nettoyage.
- Sécher le bol avec un chiffon absorbant en cas de dépôt d'eau de condensation dans le bol de la centrifugeuse.
- Frotter légèrement le joint d'étanchéité en caoutchouc du compartiment de centrifugation, après chaque nettoyage, avec de la poudre de talc ou un produit d'entretien pour caoutchouc.
- Vérifiez tous les ans le bon état de la cuve.



N'utilisez plus la centrifugeuse si elle présente des dommages susceptibles de porter atteinte à la sécurité. Auquel cas, contactez le service après-vente.

### 35.1.2 Désinfection des surfaces

- Le bol de la centrifugeuse doit être nettoyé immédiatement dans le cas où un matériau infectieux a pénétré dans le bol de la centrifugeuse.
- Substances des désinfectants adéquats :  
éthanol, n-propanol, éthylènehexanol, agents anioniques, inhibiteurs de corrosion.
- Après utilisation de désinfectants, enlevez les résidus en essuyant l'appareil avec un chiffon humide.
- Séchez immédiatement les surfaces après désinfection.

### 35.1.3 Décontamination de substances radioactives

- L'agent employé doit expressément convenir pour une décontamination de substances radioactives.
- Substances des agents adaptés à une décontamination des substances radioactives :  
agents anioniques, non ioniques agents, éthanol polyhydre.
- Après décontamination des substances radioactives, enlevez les résidus en essuyant l'appareil avec un chiffon humide.
- Séchez immédiatement les surfaces après décontamination des substances radioactives.

## 35.2 Rotors et accessoires

### 35.2.1 Nettoyage et entretien

- Afin de prévenir la corrosion et toute modification des matériaux, il faut nettoyer régulièrement les rotors et les accessoires avec du savon ou un détergent doux et un chiffon humide. Il est vivement recommandé d'effectuer un nettoyage au moins une fois par semaine. Enlevez immédiatement les impuretés.
- Substances des nettoyants adéquats :  
savon, agents anioniques et non ioniques.
- Après utilisation de nettoyants, enlevez les résidus en rinçant à l'eau claire (uniquement à l'extérieur de la centrifugeuse) ou en essuyant les surfaces avec un chiffon humide.
- Séchez rotors et accessoires immédiatement après nettoyage.
- Après séchage, les rotors d'angle, les réservoirs et la suspension en aluminium seront enduits d'une pellicule de graisse sans acide, par exemple la vaseline.
- Dans le cas des systèmes de sécurité biologique (Pour ce qui concerne les systèmes à sécurité biologique, voir le chapitre "Anhang/Appendix, Rotoren und Zubehör/Rotors and accessories") il faut contrôler et nettoyer les bagues d'étanchéité régulièrement (toutes les semaines). Changer immédiatement la bague d'étanchéité si elle présente des marques de fissuration, de friabilité et d'usure. Après chaque nettoyage, frotter légèrement les bagues d'étanchéité avec de la poudre de talc ou un produit d'entretien pour caoutchouc.
- Déposer le rotor au moins une fois par mois, nettoyer et enduire l'arbre d'entraînement d'une pellicule de graisse pour prévenir la corrosion par la présence d'humidité entre le rotor et l'arbre d'entraînement.
- Vérifier une fois par semaine l'état des rotors et des accessoires afin de détecter les éventuelles détériorations issues de l'usure et l'oxydation.

Pour les rotors à oscillation, vérifier surtout la zone de portée des tourillons et pour les balanciers, vérifier les rainures et le fond pour détecter les éventuelles fissures.

Exemple : fissures dans la rainure.

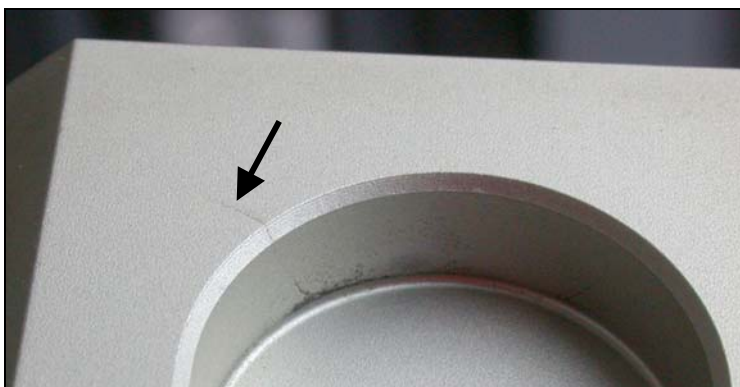

Les rotors et les accessoires usés et endommagés par la corrosion ne doivent plus être utilisés.

- Vérifier chaque semaine la stabilité de fixation du rotor.

### 35.2.2 Désinfection

- Si les rotors ou accessoires sont infectés, procédez à une désinfection appropriée.
- Substances des désinfectants adéquats :  
éthanol, n-propanol, éthylènehexanol, agents anioniques, inhibiteurs de corrosion.
- Après utilisation de désinfectants, enlevez les résidus en rinçant à l'eau claire (uniquement à l'extérieur de la centrifugeuse) ou en essuyant les surfaces avec un chiffon humide.
- Séchez rotors et accessoires immédiatement après désinfection.

### 35.2.3 Décontamination de substances radioactives

- L'agent employé doit expressément convenir pour une décontamination de substances radioactives.
- Substances des agents adaptés à une décontamination des substances radioactives :  
agents anioniques, agents non ioniques, éthanol polyhydre.
- Après décontamination des substances radioactives, enlevez les résidus en rinçant à l'eau claire (uniquement à l'extérieur de la centrifugeuse) ou en essuyant les surfaces avec un chiffon humide.
- Séchez immédiatement rotors et accessoire après décontamination des substances radioactives.

### 35.2.4 Goupilles de fixation

Les goupilles de fixation des rotors à amortissement doivent être graissées régulièrement (graisse de lubrification Hettich n° 4051) de manière à assurer le balancement régulier de la suspension.

### 35.2.5 Rotors et accessoires à durée d'utilisation limitée

L'utilisation de certains rotors, balanciers et accessoires est limitée dans le temps.

Ces limites sont indiquées par le nombre maximum de cycles ou la date limite d'utilisation et le nombre maximum de cycles, ou simplement la date limite d'utilisation, par ex. :

- "einsetzbar bis Ende: IV. Quartal 2011 / usable until end of: IV. trimestre 2011" (utilisation autorisée jusqu'à fin: IV. trimestre 2011) ou  
"einsetzbar bis Ende Monat/Jahr: 10/2011 / usable until end of month/year: 10/2011" (utilisation autorisée jusqu'à fin mois/an : 10/2011)
- "max. Laufzyklen / max. cycles: 40000" (nombre ma. de cycles 40000)



Pour des raisons de sécurité, l'utilisation de rotors, balanciers et accessoires n'est plus autorisée dès que le nombre maximum de cycles désigné ou la date limite d'utilisation inscrite sont atteints.

### 35.3 Autoclavage

Les matériels suivants peuvent être autoclavés à 121° C / 250° F (20 min) :

- rotors à oscillation
- rotors angulaires en aluminium
- balanciers en métal
- couvercles à joint d'étanchéité biologique
- châssis
- réducteurs

En cas de doute, il faut se renseigner auprès du fabricant.

Le degré de stérilité ne peut pas être indiqué.



Avant l'autoclavage, déposer le couvercle des rotors et du récipient.

L'autoclavage provoque l'accélération du vieillissement des plastiques et peut provoquer des décolorations des plastiques.

Nous recommandons le remplacement des bagues d'étanchéité de bio systèmes de sécurité après autoclave.

### 35.4 Réservoirs de centrifugation

- En cas de fuite ou de rupture de récipients de centrifugation, il faut éliminer tous les morceaux de récipients cassés, les fragments de verre et les substances centrifugées écoulées.
- Les amortisseurs antivibrations ainsi que les caoutchouc intermédiaires des rotors doivent être remplacés après un bris de verre.



Les fragments de verre restants peuvent entraîner d'autres bris de verre !

- S'il s'agit d'un matériau infectieux, exécuter immédiatement une désinfection.

### 36 Défaits

Si l'erreur ne peut pas être éliminée d'après le tableau des défauts, il faut alors avertir le service après-vente.

Veillez indiquer le type de centrifuge et le numéro de série. Les deux numéros sont indiqués sur la plaque signalétique de la centrifugeuse.



Effectuer une RÉINITIALISATION DU SECTEUR :

- Couper l'interrupteur de secteur (position de l'interrupteur "0").
- Attendre au moins 10 secondes et refermer ensuite l'interrupteur de secteur (position de l'interrupteur "1").

Message / Erreur		Origine	Solution
Pas de message	---	Pas de tension Déclenchement du fusible protecteur contre surintensité (seulement pour les types 5005-08)	<ul style="list-style-type: none"> <li>- Contrôler la tension d'alimentation</li> <li>- Secteur en marche</li> </ul>
TACHO - ERROR	01	Tachymètre défectueux.	<ul style="list-style-type: none"> <li>- Ouvrir le couvercle.</li> <li>- Couper l'interrupteur de secteur (position de l'interrupteur "0").</li> <li>- Attendre au moins 10 secondes.</li> <li>- Tourner vigoureusement le rotor à la main.</li> <li>- Refermer l'interrupteur de secteur (position de l'interrupteur "1"). Le rotor doit fonctionner pendant la mise en marche.</li> </ul>
	02	Absence de rotor. Moteur, convertisseur, entraînement défectueux.	
IMBALANCE / UNWUCHT	---	Le rotor est chargé de manière non symétrique.	<ul style="list-style-type: none"> <li>- Ouvrir le capot.</li> <li>- Vérifier le chargement du rotor, voir au chapitre "Chargement du rotor".</li> <li>- Répéter le cycle de centrifugation.</li> </ul>
CONTROL - ERROR	04, 06 - 09	Erreur du verrouillage ou de la fermeture du capot.	<ul style="list-style-type: none"> <li>- Effectuer une RÉINITIALISATION DU SECTEUR.</li> </ul>
N > MAX	05	Survitesse	
N < MIN	13	Vitesse trop basse	
ROTORCODE	10	Erreur codage du rotor	
MAINS INTERRUPT	---	Interruption du secteur pendant le cycle de centrifugation. (Le cycle de centrifugation n'est pas terminé.)	
VERSIONS-ERROR	12	Pas de correspondance entre les composants électroniques	<ul style="list-style-type: none"> <li>- Effectuer une RÉINITIALISATION DU SECTEUR.</li> </ul>
SER I/O - ERROR	30 - 38	Erreur / défectuosité de l'interface	
° C * - ERROR	50 - 56, 58	Erreur / défectuosité du refroidissement	
LOCK - ERROR	57	Erreur / défectuosité verrouillage du programme	
FU / CCI - ERROR	60 - 83	Erreur / défectuosité de la commande du moteur	
CONTROL-ERROR	26, 90 - 95, 97 - 99	Erreur / défectuosité de la commande	
N > ROTOR-MAX	96	Vitesse de rotation paramétrée dans le programme sélectionné supérieure à la vitesse maximale de rotation du rotor (n-max-Rotor).	<ul style="list-style-type: none"> <li>- Vérifier la vitesse du programme sélectionnée</li> <li>- Corriger la vitesse du programme sélectionnée</li> </ul>
		Le rotor a été remplacé. Le rotor actuellement en place a une vitesse de rotation maximale supérieure à celle du rotor utilisé précédemment et il n'a pas encore été identifié par l'identification du rotor.	<ul style="list-style-type: none"> <li>- Paramétrer une vitesse de rotation inférieure ou égale à la vitesse de rotation maximale du rotor utilisé précédemment. Appuyer sur la touche <b>START</b> pour procéder à l'identification du rotor, voir chapitre "Identification du rotor".</li> </ul>

### 37 Renvoi d'appareils au fabricant

Dans le cas où l'appareil ou ses accessoires doivent être retournés à la société Andreas Hettich GmbH & Co. KG, il faut les décontaminer et les nettoyer avant expédition, dans le but d'assurer la protection des personnes, de l'environnement et du matériel.

Nous nous réservons le droit de refuser des appareils ou des accessoires contaminés.

Nous facturons au client les frais de nettoyage et de désinfection.

Vous voudrez bien manifester votre compréhension pour cette réglementation.

### 38 Élimination des déchets

Avant de mettre l'appareil au rebut, vous devez le décontaminer et le nettoyer pour la protection des personnes, de l'environnement et du matériel.

Les dispositions légales en vigueur doivent être respectées lors de l'élimination de l'appareil.

Conformément à la directive 2002/96/CE (WEEE), tous les appareils livrés après le 13.08.2005 ne doivent plus être jetés avec les déchets ménagers. L'appareil fait partie du groupe 8 (dispositifs médicaux) et est classé dans le domaine "Business-to-Business".



Le symbole de la poubelle barrée d'une croix indique que l'appareil ne doit pas être jeté avec les déchets ménagers.

Les dispositions relatives à l'élimination des déchets des différents pays de l'UE peuvent varier. Veuillez-vous adresser en cas de besoin à votre fournisseur.



**Indice**

1	Conformità di impiego .....	83
2	Rischi residui .....	83
3	Dati tecnici .....	84
4	Indicazioni inerenti la sicurezza .....	86
5	Significato dei simboli .....	88
6	Contenuto della fornitura.....	88
7	Disimballaggio e installazione della centrifuga.....	89
8	Messa in funzione.....	89
9	Apertura e chiusura del coperchio .....	89
9.1	Apertura del coperchio.....	89
9.2	Chiusura del coperchio.....	89
10	Installazione e disinstallazione del rotore .....	90
11	Carico del rotore.....	90
12	Chiudere i sistemi biologici di sicurezza .....	91
13	Elementi di comando e visualizzazione .....	91
13.1	Indicatori di stato .....	91
13.2	Manopola .....	91
13.3	Tasti e possibilità di regolazione .....	91
14	Immettere i parametri di centrifugazione .....	92
14.1	Tempo ciclo.....	92
14.1.1	Preselezione del tempo .....	92
14.1.2	Funzionamento continuo.....	92
14.2	Numero di giri (RPM) .....	92
14.3	Accelerazione centrifuga relativa (RCF/RZB) .....	93
14.4	Parametri di avviamento e arresto .....	93
14.4.1	Livello di avviamento.....	93
14.4.2	Tempo di avviamento.....	93
14.4.3	Livello di frenatura.....	93
14.4.4	Tempo di arresto.....	93
14.4.5	Numero di giri per la disattivazione frenatura.....	93
14.5	Raggio/Temperatura .....	93
14.5.1	Raggio .....	93
14.5.2	Temperatura (solo nelle centrifughe con raffreddamento) .....	93
14.6	Memoria temporanea automatica .....	94
15	Programmazione .....	94
15.1	Impostazione/modifica del programma .....	94
15.2	Richiamo del programma .....	94
16	Centrifugazione .....	94
16.1	Centrifugazione con preselezione del tempo .....	94
16.2	Funzionamento continuo.....	95
17	Modifica delle impostazioni durante il ciclo di centrifugazione.....	95
18	Integrale RCF ( $\int$ RCF) .....	95
19	Visualizzazione del numero dei giri massimo del rotore.....	95

20	Visualizzazione del RCF massimo del rotore .....	95
21	Arresto di emergenza .....	95
22	Segnale acustico .....	96
23	Interrogazione delle ore di esercizio .....	96
24	Impostazione della data e dell'ora .....	96
25	Dati di centrifugazione visualizzati dopo l'accensione .....	96
26	Visualizzazione immediata dei dati di centrifugazione dopo l'accensione .....	96
27	Interruttore a chiave (solo nelle centrifughe con interruttore a chiave) .....	97
28	Collegamento di programma (solo nelle centrifughe con collegamento di programma) .....	97
28.1	Collegare i programmi .....	97
28.2	Modifica del collegamento di programma .....	97
28.3	Ciclo di centrifugazione con collegamento di programma .....	97
28.4	Cancellazione del collegamento di programma .....	98
29	Raffreddamento (solo per centrifuga con raffreddamento) .....	98
29.1	Raffreddamento-Standby .....	98
29.2	Pre-raffreddamento del rotore .....	98
30	Riscaldamento (solo per centrifughe con opzione di riscaldamento/ raffreddamento) .....	98
31	Accelerazione centrifuga relativa (RCF) .....	98
32	Centrifugazione di sostanze o di miscele di sostanze con densità maggiore di 1,2 kg/dm <sup>3</sup> .....	99
33	Riconoscimento del rotore .....	99
34	Sblocco di emergenza .....	99
35	Pulizia e manutenzione .....	100
35.1	Centrifughe (scatola, coperchio e vano di centrifugazione) .....	100
35.1.1	Cura e pulizia delle superfici .....	100
35.1.2	Disinfezione delle superfici .....	100
35.1.3	Rimuovere contaminazioni radioattive .....	100
35.2	Rotori ed accessori .....	101
35.2.1	Pulizia e cura .....	101
35.2.2	Disinfezione .....	101
35.2.3	Rimuovere contaminazioni radioattive .....	101
35.2.4	Perni di trascinamento .....	102
35.2.5	Rotori ed accessori con limitata durata di impiego .....	102
35.3	Mantenere in autoclave .....	102
35.4	Contenitori centrifuga .....	102
36	Guasti .....	103
37	Rispedizione di apparecchi .....	104
38	Smaltimento .....	104
39	Anhang / Appendix .....	105
39.1	Rotoren und Zubehör / Rotors and accessories .....	105

## 1 Conformità di impiego

L'apparecchio in oggetto è una centrifuga di laboratorio idonea all'uso per scopi medico-diagnostici in vitro.

Lo scopo terapeutico specifico con relativi recipienti di centrifuga è la separazione del sangue mediante centrifugazione per la trasfusione o l'auto trasfusione dei componenti del sangue ottenuti attraverso tale processo.

La centrifuga è anche idonea a preparare attraverso il processo di centrifugazione liquidi corporei umani per scopi diagnostici in vitro.

Inoltre la centrifuga è stata concepita anche per separare sostanze risp. miscele di sostanze non di origine umana con una densità massima di 1,2 kg/dm<sup>3</sup>.

La centrifuga può essere utilizzata solo da personale specializzato e in laboratori chiusi.

La centrifuga è destinata solo agli usi sopra indicati.

Un diverso od ulteriore tipo di impiego non è regolamentare. La ditta Andreas Hettich GmbH & Co. KG non si prende carico di alcuna responsabilità nel caso di danni da ciò derivanti.

Per l'impiego a norma è previsto anche il rispetto di tutte le avvertenze riportate nelle istruzioni d'uso ed il rispetto degli interventi di ispezione e di manutenzione.

## 2 Rischi residui

L'apparecchio è costruito secondo lo stato attuale della tecnica e le regole riconosciute riguardanti la tecnica della sicurezza.

In caso di uso ed impiego non regolamentari possono insorgere pericoli mortali per l'utilizzatore o per terzi risp. danni all'apparecchio o ad altri beni materiali.

L'apparecchio è destinato solo all'uso regolamentare e va utilizzato solo in uno stato perfetto per quanto riguarda la tecnica della sicurezza.

Eventuali anomalie, che possono pregiudicare la sicurezza devono essere immediatamente eliminate.

## 3 Dati tecnici

Costruttore	Andreas Hettich GmbH & Co. KG D-78532 Tuttlingen			
Modello	ROTO SILENTA 630 RS			
Tipo	5005, 5005-20, 5005-50, SK 48.06-30	5005-80	5005-90	5005-60
Tensione di rete ( $\pm 10\%$ )	400 V 3~ +N			
Frequenza di rete	50 - 60 Hz			
Potenza assorbita	9700 VA	9400 VA	6600 VA	
Assorbimento di corrente	14 A	13.5 A	9.5 A	
Tipo di refrigerante	R 404A			----
Capacità max.	12000 ml			
Densità permessa	1.2 kg/dm <sup>3</sup>			
Regime di rotazione (RPM)	6000			
Accelerazione (RCF)	6520			
Energia cinetica	215000 Nm			
Obbligo di collaudo (BGR 500)	si			
Presupposti ambientali (EN / IEC 61010-1)	<p>solo in interni fino a 2000 metri sopra il livello del mare 5°C fino a 40°C umidità relativa massima dell'aria 80% per temperature fino a 31°C, con riduzione lineare fino al 50% dell'umidità relativa per una temperatura di 40°C.</p>			
– luogo di installazione				
– altezza				
– temperatura ambiente				
– umidità dell'aria				
– Categoria di sovratensione (IEC 60364-4-443)	II			
– grado di imbrattamento	2			
Classe di protezione	I			
non adatto per l'impiego in ambiente a rischio di esplosione.				
Compatibilità elettromagnetica	EN / IEC 61326-1, classe B			
– emissione di radiointerferenze, resistenza alle interferenze				
Livello di emissione acustica (in funzione del rotore)	$\leq 62$ dB(A)		$\leq 56$ dB(A)	
dimensioni				
– larghezza	813 mm			
– profondità	1015 mm	1050 mm		
– altezza	973 mm			
Peso	ca. 355 kg	ca. 367 kg	ca. 306 kg	ca. 303 kg

Costruttore	Andreas Hettich GmbH & Co. KG D-78532 Tuttlingen		
Modello	ROTO SILENTA 630 RS		
Tipo	5005-08	5005-88	5005-98
Tensione di rete	208-220 V +6/-10% 3~ (+N) +PE		
Frequenza di rete	50 - 60 Hz		
Potenza assorbita	9000 VA	8700 VA	5200 VA
Assorbimento di corrente	25 A	24 A	14 A
Tipo di refrigerante	R 404A		
Capacità max.	12000 ml		
Densità permessa	1.2 kg/dm <sup>3</sup>		
Regime di rotazione (RPM)	6000		
Accelerazione (RCF)	6498		
Energia cinetica	215000 Nm		
Obbligo di collaudo (BGR 500)	si		
Presupposti ambientali (EN / IEC 61010-1)	<p>solo in interni</p> <p>fino a 2000 metri sopra il livello del mare</p> <p>5°C fino a 30°C   5°C fino a 40°C</p> <p>umidità relativa massima dell'aria 80% per temperature fino a 31°C, con riduzione lineare fino al 50% dell'umidità relativa per una temperatura di 40°C.</p>		
– luogo di installazione			
– altezza			
– temperatura ambiente			
– umidità dell'aria			
– Categoria di sovratensione (IEC 60364-4-443)	II		
– grado di imbrattamento	2		
Classe di protezione	I		
non adatto per l'impiego in ambiente a rischio di esplosione.			
Compatibilità elettromagnetica	EN / IEC 61326-1, classe B		
– emissione di radiointerferenze, resistenza alle interferenze			
Livello di emissione acustica (in funzione del rotore)	≤ 62 dB(A)		
dimensioni			
– larghezza	813 mm		
– profondità	1015 mm		
– altezza	973 mm		
Peso	ca. 401 kg		

#### 4 Indicazioni inerenti la sicurezza



**Se non vengono rispettate tutte le avvertenze riportate in queste istruzioni per il funzionamento, non può essere accettata da parte del costruttore alcuna richiesta di garanzia.**



- La centrifuga deve venire posizionata in modo sicuro.
- Prima di utilizzare la centrifuga, è necessario controllare che il rotore sia correttamente in sede.
- Durante un'operazione di centrifugazione, in una zona di sicurezza di 300 mm attorno alla centrifuga non deve sostare alcuna persona, materiali pericolosi ed oggetti, in conformità alle norme EN / IEC 61010-2-020.
- I rotori, le sospensioni e gli accessori che presentano forti segni di corrosione o danni meccanici, oppure la cui durata d'impiego è scaduta, non devono più essere utilizzati.
- Se il vano di centrifugazione presenta danni rilevanti per la sicurezza, la centrifuga non deve essere più messa in funzione.
- In rotori oscillanti, i perni di trascinamento devono essere lubrificati regolarmente (Grasso lubrificante Hettich no. d'ord. 4051) per consentire un'oscillazione equilibrata dei ganci.
- Nel caso di centrifughe senza regolazione termica, con temperature ambiente elevate e/o con frequente impiego dell'apparecchiatura può presentarsi un riscaldamento del vano di centrifugazione. Per questo motivo non può venire esclusa una modificazione del materiale di prova a causa alla temperatura.

- Prima di mettere in funzione la centrifuga si devono leggere ed osservare le istruzioni per l'uso. L'apparecchio può essere utilizzato solo da persone che abbiano letto e compreso le istruzioni d'uso.
- Oltre alle istruzioni per l'uso, si devono osservare anche i regolamenti, relativi alla protezione antinfortunistica ed i regolamenti tecnici, riconosciuti in materia di sicurezza del lavoro. Le istruzioni per l'uso vanno completate dalle norme nazionali in vigore nel paese d'impiego, relative alla protezione antinfortunistica ed alla tutela ambientale.
- La centrifuga è costruita in base all'attuale livello tecnologico e le regole di sicurezza conosciute. La centrifuga può essere tuttavia fonte di pericolo per l'operatore o per terzi, se non viene utilizzata da personale appositamente addestrato o se viene utilizzata in modo improprio o non conforme alla destinazione.
- Durante l'esercizio bisogna evitare di muovere la centrifuga o di urtarvi contro.
- In caso di guasto, ovvero del ripristino d'emergenza, non si deve assolutamente toccare il rotore.
- Quando la centrifuga passa da un ambiente freddo in uno caldo, per evitare danni dovuti alla condensa, lasciar riscaldare la centrifuga per almeno 3 ore nell'ambiente caldo prima di collegarla alla rete, oppure portare la centrifuga a temperatura d'esercizio mettendola in funzione per 30 minuti nell'ambiente freddo.
- Devono essere utilizzati esclusivamente i rotori e gli accessori omologati per questa apparecchiatura (vedere capitolo "Anhang/Appendix, Rotoren und Zubehör/Rotors and accessories"). Prima di utilizzare contenitori di centrifugazione, che non sono elencati nel capitolo "Appendice/Appendix, Rotori ed accessori/Rotors and accessories", l'utente deve accertarsi presso il costruttore, che questi possano venire utilizzati.
- Il rotore della centrifuga può essere caricato solo in conformità al capitolo " Carico del rotore".
- In caso di centrifugazione con massimo numero di giri, la densità dei materiali o delle miscele di materiali non deve superare il valore di composizione di  $1,2 \text{ kg/dm}^3$ .
- Non è consentito l'uso di centrifughe non bilanciate in modo regolamentare.
- Non è permesso l'impiego della centrifuga in ambiente a pericolo di esplosione.
- E' proibito l'uso di una centrifuga con:
  - materiali infiammabili od esplosivi
  - materiali che possono reagire chimicamente tra loro con forte energia.

- Se vengono centrifugate sostanze pericolose o miscele di sostanze contaminate da micro organismi tossici, radioattivi o patogeni, l'utente dovrà prendere opportuni provvedimenti in materia.  
Si devono fondamentalmente utilizzare contenitori per centrifugazione con tappi a vite speciali per sostanze pericolose. Con materiali dei gruppi di rischio 3 e 4, oltre ai contenitori per centrifugazione chiudibili si deve impiegare un sistema di sicurezza biologico (vedi manuale "Laboratory Biosafety Manual" dell'Organizzazione mondiale per la salute).  
In un sistema di sicurezza biologico una guarnizione biologica (anello di guarnizione) impedisce la fuoriuscita delle goccioline e degli aerosol.  
Se la sospensione di un sistema di sicurezza biologico viene usata senza coperchio, la guarnizione ad anello deve essere rimossa dalla sospensione per evitare di danneggiarla durante il ciclo di centrifugazione. Le guarnizioni ad anello danneggiate non possono più essere utilizzate per la chiusura a tenuta del sistema di sicurezza biologico.  
Senza l'impiego di un sistema di sicurezza biologico, una centrifuga non è microbiologicamente a tenuta in conformità alla norma EN / IEC 61010-2-020.  
Per la chiusura dei sistemi biologici di sicurezza seguire le indicazioni al capitolo "Chiudere i sistemi biologici di sicurezza".  
Per quanto riguarda i sistemi biologici di sicurezza fornibili, rimandiamo al capitolo "Anhang/Appendix, Rotoren und Zubehör/Rotors and accessories". Nel dubbio chiedere maggiori informazioni al produttore o importatore.
- Non è consentito il funzionamento della centrifuga con sostanze altamente corrosive che possono pregiudicare la resistenza meccanica dei rotori, delle sospensioni e degli accessori.
- Gli interventi di riparazione devono essere effettuati esclusivamente da una persona autorizzata dal costruttore.
- Devono essere impiegati solo ed esclusivamente pezzi di ricambio originali ed accessori autorizzati della ditta Andreas Hettich GmbH & Co. KG.
- Sono di validità le seguenti norme di sicurezza:  
EN / IEC 61010-1 e EN / IEC 61010-2-020 come anche le loro nazionali varianti.
- La sicurezza e l'affidabilità della centrifuga sono garantite solo se:
  - la centrifuga funziona in conformità con le istruzioni per l'uso
  - l'installazione elettrica sul luogo di posizionamento della centrifuga risponde ai requisiti previsti dalla EN / IEC
  - i collaudi che riguardano la sicurezza dell'apparecchiatura e che sono prescritti nei diversi Stati, p.es. in Germania conformemente alle norme BGV A1 e BGR 500, vengono eseguiti da parte di un perito.

## 5 Significato dei simboli



Simbolo sull'apparecchio:

Attenzione, punto pericoloso generico.

Prima di utilizzare l'apparecchiatura leggere in ogni caso le istruzioni per l'uso ed osservare le istruzioni rilevanti per la sicurezza!



Simbolo in questo documento.

Attenzione, punto pericoloso generico.

Questo simbolo contraddistingue le avvertenze relative alla sicurezza e indica situazioni potenzialmente pericolose .

La mancata osservanza di tali avvertenze può causare danni materiali e personali.



Simbolo sull'apparecchiatura ed in questo documento:

Attenzione: rischio biologico.



Simbolo sull'apparecchiatura ed in questo documento:

Attenzione alle superfici molto calde.

Il mancato rispetto di questa avvertenza può portare a danneggiamenti alle cose e alle persone.



Simbolo sull'apparecchiatura:

Equipotenziale: connettore a spina (connettore PA) per collegamento equipotenziale (solo nelle centrifughe con connettore PA).



Simbolo sull'apparecchiatura:

Posizioni dell'interruttore a chiave.



Simbolo in questo documento:

Questo simbolo indica argomenti importanti.



Simbolo sull'apparecchiatura ed in questo documento:

Simbolo per la raccolta separata delle apparecchiature elettriche ed elettroniche, in conformità alle direttive 2002/96/CEE (WEEE). L'apparecchiatura appartiene al gruppo 8 (apparecchiature medicali).

Impiego nelle nazioni dell'Unione Europea, in Norvegia ed in Svizzera.

## 6 Contenuto della fornitura

- 4 Supporto antivibrante
- 1 Chiave doppia 17/19
- 1 Chiave a forcella
- 1 Grasso per perni portanti
- 1 Istruzioni per l'uso
- 3 Informazioni sulla programmazione dell'apparecchio
- 1 Informazioni su come rimuovere l'imballo
- 1 Informazioni sull'installazione

Rotore/i e i corrispondenti accessori vengono forniti in base alla commessa.



## 7 Disimballaggio e installazione della centrifuga

Disimballare ed installare la centrifuga secondo le schede informative in dotazione AH5005XX e AH5005-01XX.

## 8 Messa in funzione

- Secondo la norma sugli strumenti di laboratorio EN / IEC 61010-2-020 gli impianti domestici devono essere provvisti di apposito sezionatore d'emergenza per l'interruzione della rete in caso di guasto. L'interruttore deve essere posizionato distante dalla centrifuga, preferibilmente al di fuori della stanza in cui è posizionata la centrifuga o vicino all'uscita.
- Secondo la norma sugli strumenti di laboratorio IEC 61010-1 nell'impianto dell'edificio deve essere messo un interruttore, conforme alla norma IEC 60947-5-3, per disinserire l'alimentazione elettrica dell'apparecchio. Tale interruttore deve trovarsi nelle vicinanze dell'apparecchio, deve essere facilmente raggiungibile per l'operatore e deve essere contrassegnato come dispositivo di disconnessione per questo apparecchio. L'interruttore deve poter essere inoltre assicurato contro un reinserimento.
- I tipi 5005-90, 5005-08, 5005-88 e 5005-98 sono apparecchi a collegamento fisso.
- I tipi 5005-80, 5005-90, 5005-08, 5005-88 e 5005-98 possono essere installati solo da personale specializzato e autorizzato.



Questi apparecchi devono essere installati secondo le istruzioni di montaggio e installazione AH5005-02EN allegate.

- **Porre la centrifuga in un posto adatto e livellarla. Per l'installazione deve essere rispettata la zona di sicurezza di 300 mm attorno alla centrifuga, richiesta in conformità alle norme EN / IEC 61010-2-020.**



**Durante un'operazione di centrifugazione, in una zona di sicurezza di 300 mm attorno alla centrifuga non deve sostare alcuna persona, materiali pericolosi ed oggetti, in conformità alle norme EN / IEC 61010-2-020.**

- Non posizionare alcun oggetto in prossimità delle griglie di ventilazione. Mantenere un'area di ventilazione di 300 mm, intorno al condotto.
- Centrifuga con connettore PA:  
all'occorrenza collegare il connettore PA sul retro dell'apparecchio con un sistema di collegamento equipotenziale medico aggiuntivo.
- Verificare se la tensione di rete sia adatta all'indicazione riportata nella targhetta con i dati caratteristici.
- Nei tipi 5005, 5005-50, 5005-80 ed SK 48.06-30:  
Collegare la centrifuga ad una spina standard di rete tramite il cavo di collegamento. Per la potenza massima assorbita, vedere il capitolo "Dati tecnici".
- Inserire l'interruttore di rete elettrica presente nell'impianto dell'edificio.
- Inserire l'interruttore di rete sul pannello anteriore. Posizione di accensione "I".  
Compare l'indicazione:  
1. Tipo di centrifuga, 2. il codice rotore rilevato per ultimo dal riconoscimento rotore e il numero di giri massimo del rotore (n-max-rotore), 3. Versione del programma, 4. **OPEN** **OEFFNEN**.
- Aprire il coperchio.  
Vengono illustrati i dati di centrifuga del programma utilizzato per ultimo o del programma 1.

## 9 Apertura e chiusura del coperchio

### 9.1 Apertura del coperchio



E' possibile aprire il coperchio solo se la centrifuga è accesa ed il rotore è fermo.  
Se non dovesse essere possibile, vedi capitolo "Sblocco di emergenza".

- Premere il tasto sul pannello anteriore. Il coperchio si sblocca a motore, l'illuminazione del tasto si spegne e nell'indicazione il simbolo si trasforma nel simbolo .

### 9.2 Chiusura del coperchio



Non afferrare con le dita tra il coperchio e il rivestimento.  
Non chiudere il coperchio sbattendolo.

- Appoggiare il coperchio e spingerlo leggermente in basso mediante la maniglia tubolare. La chiusura avviene grazie ad un sistema motorizzato. Il tasto si illumina e sul display il simbolo si modifica nel simbolo .

## 10 Installazione e disinstallazione del rotore

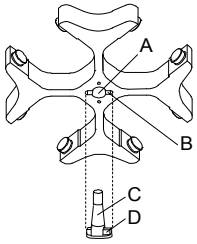

- Pulire l'albero motore (C) ed il foro del rotore (A), successivamente lubrificare leggermente l'albero motore. Particelle di sporco tra l'albero motore ed il rotore impediscono un normale funzionamento del rotore e causano un movimento rumoroso.
- Porre il rotore in senso verticale sull'albero motore. Il meccanismo di trascinarsi dell'albero motore (D) deve trovarsi nella scanalatura del rotore (B). Sul rotore è segnato l'allineamento della scanalatura.
- Stringere il dado di registrazione di tensione del rotore con l'aiuto della chiave inclusa nel cartone, ruotandola in senso orario.
- Verificare che il rotore sia fissato.
- Disinstallare il rotore: svitare il dado di registrazione di tensione, ruotandolo in senso anti-orario fino a che non abbia raggiunto il punto di completo svitamento. Con il punto di svitamento completo, il rotore si può smontare dal cono dell'albero motore. Girare il dado di registrazione di tensione fino a che diventi possibile smontare il rotore dall'albero motore.

## 11 Carico del rotore



Lo standard dei recipienti di vetro centrifugati sono da caricare fino a RCF 4000 (DIN 58970 capoverso 2).

- Verificare che il rotore sia fissato.
- Nel caso di rotori oscillanti, tutti i siti del rotore devono essere muniti di ganci **uguali**. Particolari ganci sono contrassegnati con il numero del sito del rotore. Questi ganci devono essere applicati solo nel relativo sito del rotore.

Ganci contrassegnati con un numero di kit, p.es. S001/4, devono essere utilizzati esclusivamente in kit.

- I rotori ed i ganci devono essere caricati esclusivamente in modo simmetrico. I recipienti di centrifuga devono essere distribuiti uniformemente su tutti i posti del rotore. Per le combinazioni permesse vedere capitolo "Anhang/Appendix, Rotoren und Zubehör/Rotors and accessories".

In caso di rotori angolari devono essere caricati tutti i possibili siti del rotore, vedere il capitolo "Anhang/Appendix, Rotoren und Zubehör/Rotors and accessories".

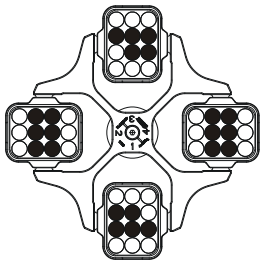

Il rotore è caricato uniformemente

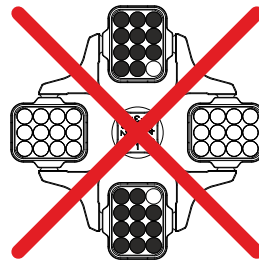

**Non ammesso!**

Il rotore è caricato in modo non uniforme

- Su certe sospensioni è indicato il peso del carico massimo oppure il peso del carico massimo e il peso massimo della sospensione completamente equipaggiata. Questi pesi non devono essere superati. In casi eccezionali vedere al capitolo "Centrifugazione di sostanze o di miscele di sostanze con densità maggiore di  $1,2 \text{ kg/dm}^3$ ". Il peso indicato per il carico massimo comprende il peso completo di riduttore, supporto, provetta da centrifuga e contenuto.
- Nel caso di contenitori con inserimenti in gomma, deve essere sempre mantenuto lo stesso numero di inserimenti in gomma sotto i contenitori di centrifugazione.
- L'operazione di riempimento dei contenitori di centrifugazione è ammessa solo al di fuori della centrifuga.
- Il carico massimo dei recipienti della centrifuga non deve essere superiore a quello indicato dalla casa costruttrice.

Con rotori a squadra, il riempimento dei contenitori di centrifugazione è consentito solo fino al livello per cui, durante l'operazione di centrifugazione, non venga espulso alcun liquido dai contenitori.

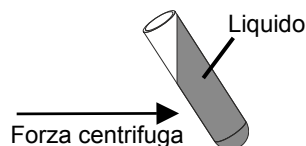

- Con il caricamento di rotori a squadra non deve pervenire alcun liquido nei rotori a squadra e nel vano di centrifugazione.
- Con il caricamento dei ganci dei rotori di smorzamento come anche con lo smorzamento dei ganci durante l'operazione di centrifuga non deve pervenire alcun liquido nei ganci e nel vano di centrifugazione.
- Per limitare al massimo le differenze di peso all'interno dei contenitori di centrifugazione, bisogna fare attenzione che siano riempiti tutti in modo uguale.

## 12 Chiudere i sistemi biologici di sicurezza



Per garantire la tenuta, il coperchio di un sistema biologico di sicurezza deve essere ben chiuso.

Per evitare che durante l'apertura e la chiusura del coperchio l'anello di guarnizione si giri, spalmarvi, frizionando leggermente, polvere di talco o una sostanza per la cura della gomma.

Per quanto riguarda i sistemi biologici di sicurezza fornibili, rimandiamo al capitolo "Anhang/Appendix, Rotoren und Zubehör/Rotors and accessories". Nel dubbio chiedere maggiori informazioni al produttore o importatore.

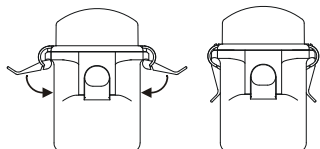

Coperchio con chiusura a scatto:

- Posizionare il coperchio sulle sospensioni e spingere in basso le due staffe fino a farle arrivare sotto le ganasce delle sospensioni.
- Ribaltare completamente verso il basso le due staffe. Le staffe devono trovarsi sull sospensioni.

## 13 Elementi di comando e visualizzazione

Vedere illustrazione alla pagina 2.

Fig. 2: Pannello di visualizzazione e di comando

### 13.1 Indicatori di stato



Coperchio aperto



Coperchio chiuso.



Indicazione della centrifugazione. L'indicazione avviene durante il ciclo di centrifugazione, per quanto giri il rotore.

**STOP**

Ciclo di centrifugazione interrotto o terminato. Indicazione al termine del ciclo di centrifugazione, per quanto giri il rotore. L'indicatore lampeggia dopo un arresto d'emergenza.

**LOCK 1,**  
**LOCK 2**

Posizione di commutazione dell'interruttore a chiave.

**LOCK 4,**  
**LOCK 5**

Blocco del programma con comunicazione seriale (solo nelle centrifughe con comunicazione seriale).

**PC, PE**

Comunicazione seriale (solo nelle centrifughe con comunicazione seriale).

Errori di comando ovv. anomalie che si presentano vengono visualizzati nel display (vedi capitolo "Guasti").

### 13.2 Manopola



Per l'impostazione dei singoli parametri.

La rotazione in senso antiorario riduce il valore. La rotazione in senso orario aumenta il valore.

### 13.3 Tasti e possibilità di regolazione



Tempo ciclo, parametro t/min:sec

1. Parametro t/min: Impostabile da 1 - 999 min., ad intervalli di 1 min.

2. Parametro t/sec Impostabile da 1 - 59 sec., ad intervalli di 1 secondo.

3. Funzionamento continuo "---:--"



Interrogazione dell'integrale RCF, parametro ∫RCF.



1. Numero di giri, parametro RPM

È impostabile un valore numerico di 50 rpm fino al numero di giri massimo del rotore (n-max-Rotor). Per il numero di giri massimo del rotore, vedi capitolo "Anhang/Appendix, Rotoren und Zubehör/Rotors and accessories". Regolabile ad intervalli di 10.

2. Interrogazione del numero di giri massimo del rotore, parametro n-max-Rotor.



1. Accelerazione centrifuga relativa, parametro RCF/RZB  
È impostabile un valore numerico con il quale si ottiene un numero di giri compreso tra 50 rpm ed il numero di giri massimo del rotore (n-max-rotore). Regolabile ad intervalli di 1.
2. Interrogazione del RCF massimo del rotore, parametro RCF-max-Rotor.



- Parametri di avviamento
1. Livelli di avviamento, parametri  $\curvearrowright$  1-9. Livello 9 = tempo di avviamento più breve, ... Livello 1 = tempo di avviamento più lungo.
  2. Tempo di avviamento, parametri  $\curvearrowright$  min:sec. Il campo di durata regolabile dipende dal numero di giri impostato.



- Parametri di arresto
1. Livelli di rallentamento, parametri  $\curvearrowleft$  0-9. R = curva di frenatura lineare, B = simile ad una curva di frenatura esponenziale. Livello R9, B9 = tempo di arresto breve, ... Livello R1, B1 = tempo di arresto lungo, livello R0 = arresto graduale senza frenatura.
  2. Tempo di arresto, parametri  $\curvearrowleft$  min:sec. Il campo di durata regolabile dipende dal numero di giri impostato.
  3. Numero di giri per la disattivazione frenatura, parametro n<sup>(c)</sup>/RPM  
Al raggiungimento di questo numero di giri si ha un arresto graduale senza frenatura.



1. Valore nominale temperatura, parametro T/°C. Regolabile da -20°C a +40°C, ad intervalli di 1°C (regolabile con opzione di riscaldamento/ raffreddamento da -20 °C a +90°C. La più bassa temperatura raggiunta dipende dal rotore (vedi capitolo "Anhang/Appendix, Rotoren und Zubehör/Rotors and accessories").
2. Raggio di centrifugazione, parametro r/mm. Immissione in mm. Per il raggio di centrifugazione, vedi capitolo "Anhang/Appendix, Rotoren und Zubehör/Rotors and accessories".



1. Avviare il ciclo di centrifugazione. Si attiva l'indicazione della centrifugazione  $\odot$ .
2. Adozione di modifiche durante il ciclo di centrifugazione.



Terminare il ciclo di centrifugazione.  
Il rotore si arresta gradualmente con il parametro di arresto prestabilito. Una doppia pressione del tasto fa scattare l'arresto di emergenza.



Selezionare la posizione di programma, parametro PROG-Nr.



Richiamo di programmi.



Memorizzazione di programmi.  
Possono essere memorizzati 89 programmi (posizioni di programma da 1 a 89). Nota: Le posizioni di programma "----" e 90 fino a 99 servono come memoria temporanea automatica (vedi capitolo "Memoria temporanea automatica"). In queste posizioni programma non possono essere memorizzati programmi.

## 14 Immettere i parametri di centrifugazione



L'immissione di un parametro è solo possibile se il campo d'immissione viene visualizzato in modo invertito (con sfondo scuro). Un campo d'immissione invertito si spegne automaticamente dopo 10 secondi.

### 14.1 Tempo ciclo

#### 14.1.1 Preselezione del tempo

- Premere ripetutamente il tasto  $\square$  fino a che viene visualizzato il parametro t/min: o t/ :sec. Il campo d'immissione viene visualizzato in modo invertito.
- Con la manopola  $\odot$  impostare il valore voluto.



#### 14.1.2 Funzionamento continuo

- Selezionare uno dopo l'altro i parametri t/min: e t/ :sec (vedi capitolo "Preselezione del tempo"), e regolarli entrambi su zero tramite la manopola  $\odot$ . Nel campo d'immissione viene visualizzato "---:--".

### 14.2 Numero di giri (RPM)

- Premere ripetutamente il tasto  $\square$  fino a che viene visualizzato il parametro RPM e il campo d'immissione appare in modo invertito.
- Con la manopola  $\odot$  impostare il valore voluto.

### 14.3 Accelerazione centrifuga relativa (RCF/RZB)

- Premere ripetutamente il tasto  fino a che viene visualizzato il parametro RCF/RZB ed il campo d'immissione appare in modo invertito.
- Con la manopola  impostare il valore voluto.

Durante la regolazione lampeggia l'indicatore del raggio di centrifugazione.

### 14.4 Parametri di avviamento e arresto





Vengono visualizzati i parametri di avviamento e di arresto impostati.





x: 1-9 = livello di avviamento, t = tempo di avviamento

y: R1-R9, B1-B9 = livello di frenatura, R0 = arresto graduale senza frenatura, t = tempo di arresto, n<sup>(\*)</sup> = numero di giri per la disattivazione frenatura

#### 14.4.1 Livello di avviamento





- Premere ripetutamente il tasto  fino a che viene visualizzato il parametro <sub>1-9</sub> oppure . Il campo d'immissione viene visualizzato in modo invertito.
- Con la manopola  impostare il livello voluto.

#### 14.4.2 Tempo di avviamento

- Premere ripetutamente il tasto  fino a che viene visualizzato il parametro <sub>min.sec</sub>. Il campo d'immissione viene visualizzato in modo invertito.
- Con la manopola  impostare il valore voluto.

Se viene impostato un tempo di avviamento che è più lungo del tempo ciclo, il ciclo di centrifugazione termina prima di aver raggiunto il numero di giri impostato.



#### 14.4.3 Livello di frenatura

- Premere ripetutamente il tasto  fino a che viene visualizzato il parametro <sub>0-9</sub> oppure . Il campo d'immissione viene visualizzato in modo invertito.
- Con la manopola  impostare il livello voluto.



Livelli di rallentamento B possono essere impostati solo con rotor speciali.

#### 14.4.4 Tempo di arresto

Se è impostato un numero di giri per la disattivazione frenatura, non è impostabile alcun tempo di arresto.



- Premere ripetutamente il tasto  fino a che viene visualizzato il parametro <sub>min.sec</sub>. Il campo d'immissione viene visualizzato in modo invertito.
- Con la manopola  impostare il valore voluto.

#### 14.4.5 Numero di giri per la disattivazione frenatura

- Premere ripetutamente il tasto  fino a che viene visualizzato il parametro n<sup>(\*)</sup>/RPM. Il campo d'immissione viene visualizzato in modo invertito.
- Con la manopola  impostare il valore voluto.



### 14.5 Raggio/Temperatura

#### 14.5.1 Raggio

- Premere ripetutamente il tasto  fino a che viene visualizzato il parametro r/mm ed il campo d'immissione appare in modo invertito.
- Con la manopola  impostare il valore voluto.

Modificando il raggio, il valore del RCF/RZB viene adattato automaticamente, il che viene visualizzato tramite il lampeggiamento.

#### 14.5.2 Temperatura

- Premere ripetutamente il tasto  fino a che viene visualizzato il parametro T/°C ed il campo d'immissione appare in modo invertito.
- Con la manopola  impostare il valore voluto.

## 14.6 Memoria temporanea automatica

La memoria temporanea comprende le posizioni programma "----" e 90 a 99. Dopo ogni avvio di un ciclo di centrifugazione, i dati di centrifugazione modificati vengono memorizzati automaticamente nella posizione di programma "----". Di dati di centrifugazione modificati degli ultimi 11 cicli di centrifugazione sono memorizzati nella memoria temporanea e possono essere richiamati (vedi capitolo "Richiamo del programma").

## 15 Programmazione

### 15.1 Impostazione/modifica del programma

- Impostare i parametri voluti (vedi capitolo "Immettere i parametri di centrifugazione").
- Premere il tasto **[PROG]** per selezionare il parametro PROG-Nr. Il campo d'immissione viene visualizzato in modo invertito.
- Con la manopola **○** impostare la posizione di programma voluta.  
Se l'indicatore della posizione di programma lampeggia, questa posizione di programma è già occupata da dati di centrifugazione. In questo caso è necessario impostare una posizione di programma libera oppure sovrascrivere i dati di centrifugazione con Continua.
- Premere 1x il tasto **[STOP]** per memorizzare le impostazioni sulla posizione di programma voluta.  
Premere 2x il tasto **[STOP]** per sovrascrivere dati di centrifugazione già salvati.

### 15.2 Richiamo del programma

- Premere il tasto **[PROG]** per selezionare il parametro PROG-Nr. Il campo d'immissione viene visualizzato in modo invertito.
- Con la manopola **○** impostare la posizione di programma voluta.
- Premere il tasto **[RCL]**. Vengono visualizzati i dati di centrifugazione della posizione di programma selezionata.

## 16 Centrifugazione



Durante un'operazione di centrifugazione, in una zona di sicurezza di 300 mm attorno alla centrifuga non deve sostare alcuna persona, materiali pericolosi ed oggetti, in conformità alle norme EN / IEC 61010-2-020.



Nel caso in cui la differenza di peso permessa nel caricamento del rotore venga superata, si ferma l'azionamento durante l'avvio, e compare la dicitura **IMBALANCE / UNWUCHT**.

Se il numero di giri nel programma selezionato è più elevato del numero di giri massimo del rotore (n-max-rotore), non è possibile avviare un ciclo di centrifugazione. Viene visualizzato **N > ROTOR MAX 96** (vedi capitolo "Guasti").

Una corsa di centrifugazione può essere interrotta in ogni momento premendo il tasto **[STOP]**

Con i tasti **[RPM]** e **[RCF]** è possibile passare in ogni momento dalla visualizzazione RPM a quella RCF e viceversa. Se si lavora con la visualizzazione RCF, è necessario immettere il raggio di centrifugazione.

Se compaiono le diciture **◀ OPEN ▶ OEFFNEN (=APRIRE)**, è possibile un'operazione della centrifuga solo dopo aver aperto una volta il coperchio.

Se viene visualizzato **R xx n-max xxxxx**, non ha avuto luogo alcun processo di centrifugazione in quanto è stato sostituito il rotore, vedere il capitolo "Riconoscimento del rotore".



- Accendere l'interruttore di rete. Posizione dell'interruttore **I**.
- Caricare il rotore e chiudere il coperchio della centrifuga.

### 16.1 Centrifugazione con preselezione del tempo

- Impostare il tempo o richiamare un programma con preselezione del tempo (vedi capitolo "Immettere i parametri di centrifugazione" o "Richiamo del programma").
- Premere il tasto **[START]**. L'indicazione della centrifugazione **●** rimane attiva finché gira il rotore.
- Una volta scaduto il tempo o in caso di interruzione del ciclo di centrifugazione premendo il tasto **[STOP]**, si ha un arresto graduale con il parametro di arresto selezionato. Dopo il fermo completo del rotore, il simbolo **■** nel visualizzatore continua a lampeggiare fino a che viene aperto il coperchio.

Durante il ciclo di centrifugazione vengono visualizzati il numero di giri del rotore o il valore RCF che ne risulta, la temperatura campione ed il tempo residuo.

## 16.2 Funzionamento continuo

- Impostare il simbolo ---:-- einstellen o richiamare un programma di funzionamento continuo (vedi capitolo "Immettere i parametri di centrifugazione" o "Richiamo del programma").
- Premere il tasto **[START]**. L'indicazione della centrifugazione  rimane attiva finché gira il rotore. Il conteggio del tempo parte da 00:00.
- Premere il tasto **[STOP]** per terminare il ciclo di centrifugazione. L'arresto avviene con il parametro di arresto selezionato. Dopo il fermo completo del rotore, il simbolo  nel visualizzatore continua a lampeggiare fino a che viene aperto il coperchio.

Durante il ciclo di centrifugazione vengono visualizzati il numero di giri del rotore o il valore RCF che ne risulta, la temperatura campione ed il tempo trascorso.

## 17 Modifica delle impostazioni durante il ciclo di centrifugazione

Il tempo ciclo, il numero di giri, l'accelerazione centrifuga relativa (RCF/RZB), i parametri di avviamento e di arresto nonché la temperatura possono essere modificate durante il ciclo di centrifugazione.

I parametri possono essere modificati solo ad uno ad uno e uno dopo l'altro.

- Selezionare il parametro voluto e modificare il valore con la manopola  (vedi capitolo "Immettere i parametri di centrifugazione").
- Premere il tasto **[START]**. L'impostazione modificata viene memorizzata sulla posizione di programma "----" (vedi capitolo "Memoria temporanea automatica"). Il programma originale non viene sovrascritto.

## 18 Integrale RCF ( $\int$ RCF)

L'integrale RCF ( $\int$ RCF) è una misura per l'effetto di sedimentazione ( $\int n^2 dt$ ). Questo valore numerico serve per confrontare cicli di centrifugazione. Per l'interrogazione dell'integrale RCF, mantenere premuto il tasto **[RCF]**.

## 19 Visualizzazione del numero dei giri massimo del rotore

- Premere ripetutamente il tasto **[n]** fino a che viene visualizzato il parametro RPM ed il campo d'immissione appare in modo invertito.
- Premere ancora 1x il tasto **[n]** e tenerlo premuto, viene visualizzato il numero di giri massimo del rotore (n-max-Rotor).

## 20 Visualizzazione del RCF massimo del rotore

- Premere ripetutamente il tasto **[RCF]** fino a che viene visualizzato il parametro RCF/RZB ed il campo d'immissione appare in modo invertito.
- Premere ancora 1x il tasto **[RCF]** e tenerlo premuto, viene visualizzato il RCF massimo del rotore (RCF-max-Rotor).

## 21 Arresto di emergenza

- Premere 2x il tasto **[STOP]**. Nel visualizzatore lampeggia il simbolo **STOP**.

Nell'arresto di emergenza l'arresto avviene con il livello di frenatura R9 (tempo di arresto più breve). Se era stato preselezionato il livello di frenatura R0, per ragioni tecniche il tempo di arresto è più lungo che con il livello di frenatura R9.

## 22 Segnale acustico

Il segnale acustico risuona dopo la seguente impostazione:

<b>OFF</b>	<ul style="list-style-type: none"> <li>all'insorgere di un'anomalia nell'intervallo di 2 sec.</li> </ul>
<b>ON1</b>	<ul style="list-style-type: none"> <li>all'insorgere di un'anomalia nell'intervallo di 2 sec.</li> <li>al termine del ciclo di centrifugazione e con il fermo completo del rotore nell'intervallo di 30 sec.</li> </ul>
<b>ON2</b>	<ul style="list-style-type: none"> <li>all'insorgere di un'anomalia nell'intervallo di 2 sec.</li> <li>al termine del ciclo di centrifugazione e con il fermo completo del rotore nell'intervallo di 30 sec.</li> <li>ad ogni pressione di un tasto.</li> </ul>

Il segnale acustico termina aprendo il coperchio o premendo un tasto qualsiasi.

A rotore fermo, il segnale può essere regolato nel modo seguente:

- Aprire il coperchio.
- Tenere premuto il tasto **[ ]** per 8 secondi.  
Dopo 8 secondi viene visualizzato **SOUND / BELL XXX**.
- Con la manopola **○**, impostare la funzione voluta (OFF, ON1, ON2).
- Premere il tasto **[START]** per memorizzare l'impostazione.  
In segno di conferma viene brevemente visualizzato **\*\*\* ok \*\*\***.

## 23 Interrogazione delle ore di esercizio

L'interrogazione delle ore di esercizio è possibile solo a rotore fermo.

- Aprire il coperchio.
- Tenere premuto il tasto **[ ]** per 8 secondi.  
Dopo 8 secondi viene visualizzato **SOUND / BELL XXX**.
- Premere ancora 1x il tasto **[ ]**.  
Vengono visualizzate le ore di esercizio (**CONTROL:** ) della centrifuga.  
La visualizzazione delle ore di esercizio si spegne automaticamente dopo 10 secondi.

## 24 Impostazione della data e dell'ora

L'impostazione della data e dell'ora è solo possibile a rotore fermo.

- Aprire il coperchio.
- Tenere premuto il tasto **[ ]** per 8 secondi.  
Dopo 8 secondi viene visualizzato **SOUND / BELL XXX**.
- Premere ancora 2x il tasto **[ ]**.  
Vengono visualizzati la data e l'ora (a: anno, mon: mese, d: giorno, h: ore, min: minuti).
- Premere ripetutamente il tasto **[ ]** fino a che il campo d'immissione del parametro voluto viene indicato in modo invertito.
- Con la manopola **○** impostare il valore voluto.
- Premere il tasto **[START]** per memorizzare l'impostazione.  
In segno di conferma viene brevemente visualizzato **\*\*\* ok \*\*\***.
- Per uscire dall'impostazione della data e dell'ora, premere un tasto qualsiasi all'infuori i tasti **[ ]**, **[ ]** ed **[START]**.

## 25 Dati di centrifugazione visualizzati dopo l'accensione

Dopo l'accensione vengono visualizzati i dati di centrifugazione del programma 1 oppure quelli dell'ultimo programma utilizzato. Ciò può essere impostato come segue:

- Aprire il coperchio.
- Spegnere e riaccendere l'interruttore di rete. Posizione dell'interruttore **I**.
- Alla prima modifica visiva nel visualizzatore (visualizzazione invertita), premere il tasto **[STOP]**.  
Viene visualizzato **PROGRAM 1, LAST PROGRAM**.
- Con la manopola **○**, impostare la funzione voluta.
- Premere il tasto **[START]** per memorizzare l'impostazione.  
In segno di conferma viene brevemente visualizzato **\*\*\* ok \*\*\***.

## 26 Visualizzazione immediata dei dati di centrifugazione dopo l'accensione

- Accendere l'interruttore di rete. Posizione dell'interruttore **I**.
- Alla prima modifica visiva nel visualizzatore (visualizzazione invertita), premere un tasto qualsiasi all'infuori del tasto **[STOP]**. I dati di centrifugazione vengono visualizzati immediatamente.



## 27 Interruttore a chiave

Con l'interruttore a chiave possono essere impostati i seguenti blocchi del programma:

Posizione con chiave a sinistra:	Viene visualizzato <b>LOCK 1</b> . I programmi possono essere solo richiamati, non modificati.
Posizione con chiave a destra:	Viene visualizzato <b>LOCK 2</b> . I programmi non possono essere né richiamati né modificati.
Posizione con chiave in mezzo:	nessuna indicazione di stato. Nessun blocco del programma. I programmi possono essere richiamati e modificati.

## 28 Collegamento di programma (solo nelle centrifughe con collegamento di programma)

Grazie al collegamento di programma è possibile collegare più cicli di centrifugazione.

### 28.1 Collegare i programmi



Un collegamento di programma è solo possibile con programmi nei quali sono impostati i livelli di avvio e di frenatura.

Prima del collegamento è necessario che i programmi vengano memorizzati nella successione voluta tramite l'impostazione del programma oppure tramite il richiamo del programma (vedi capitolo "Programmazione").

Le posizioni programma devono trovarsi in successione diretta (ad es. posizioni programma 10+11+12).

1. Premere il tasto **PROG** per selezionare il parametro PROG-Nr. Il campo d'immissione viene visualizzato in modo invertito.
2. Tramite la manopola  $\odot$ , impostare la posizione di programma del programma iniziale (XX+).
3. Premere il tasto **RCL**. Vengono visualizzati i dati di centrifugazione della posizione di programma selezionata.
4. Premere 2x il tasto **PROG** per selezionare il parametro PR-PART. Il campo d'immissione viene visualizzato in modo inverso.
5. Premere 2x il tasto **STO**. Il programma viene collegato e viene visualizzato il numero di programma della posizione di programma successiva (+XX+).
6. Premere 2x il tasto **RCL**. Vengono visualizzati i dati di centrifugazione della posizione di programma selezionata.
7. Premere 2x il tasto **STO**. Il programma viene collegato e viene visualizzato il numero di programma della posizione di programma successiva (+XX+).
8. Ripetere i passi 6 e 7 fino a che tutti i programmi sono collegati.
9. Per terminare, premere il tasto **PROG**. Viene visualizzato il numero di programma del programma finale (+XX).

### 28.2 Modifica del collegamento di programma

- Richiamare il programma voluto (vedi capitolo "Richiamo del programma"), modificare i parametri voluti (vedi capitolo "Immettere i parametri di centrifugazione") e memorizzare nuovamente i dati di centrifugazione sulla stessa posizione di programma (vedi capitolo "Impostazione/modifica del programma"). La memorizzazione elimina il collegamento di programma.
- Ricollegare i programmi (vedi capitolo "Collegare i programmi").

### 28.3 Ciclo di centrifugazione con collegamento di programma

- Premere 2x il tasto **PROG** per selezionare il parametro PR-PART. Il campo d'immissione viene visualizzato in modo invertito.
- Tramite la manopola  $\odot$ , impostare la posizione di programma del programma iniziale (XX+).
- Premere il tasto **RCL**. Vengono visualizzati i dati di centrifugazione della posizione di programma selezionata.
- Premere il tasto **START**. L'indicazione della centrifugazione  $\odot$  rimane attiva finché gira il rotore. Vengono visualizzati i livelli di avvio e di frenatura del collegamento di programma:



Programma iniziale (XX+)  
x: Livello di avviamento del programma iniziale



Programma successivo (+XX+)  
x: Livello di avviamento del programma successivo



Programma finale (+XX)  
x: Livello di avviamento del programma finale  
y: Livello di frenatura del programma finale

- Una volta scaduto il tempo nel programma finale si ha un arresto graduale con il livello di frenatura del programma finale. In caso di interruzione del ciclo di centrifugazione tramite pressione del tasto **STOP**, si ha un arresto graduale con il livello di frenatura del programma al momento in corso.

## 28.4 Cancellazione del collegamento di programma

- Premere il tasto **[PROG]** per visualizzare il parametro PROG-Nr. Il campo d'immissione viene visualizzato in modo invertito.
- Tramite la manopola **○**, impostare la posizione di programma del programma iniziale (XX+).
- Premere il tasto **[RCL]**. Vengono visualizzati i dati di centrifugazione della posizione di programma selezionata.
- Premere 2x il tasto **[PROG]** per visualizzare il parametro PR-PART. Il campo d'immissione viene visualizzato in modo invertito.
- Premere 2x il tasto **[STO]**.
- Premere il tasto **[PROG]**.

## 29 Raffreddamento (solo per centrifuga con raffreddamento)

Il valore nominale di temperatura può essere selezionata da -20°C fino a +40°C. Nelle centrifughe con l'opzione di riscaldamento/ raffreddamento, il valore nominale della temperatura è regolabile da -20 °C a +90 °C. La temperatura minima raggiungibile dipende dal rotore (vedere capitolo "Anhang/Appendix, Rotoren und Zubehör/Rotors and accessories"). Se la differenza tra la temperatura Nominale e quella Reale è superiore a 5°C, lampeggia l'indicazione temperatura.

### 29.1 Raffreddamento-Standby

Con l'arresto del rotore e coperchio chiuso, la camera di centrifugazione viene raffreddata alla temperatura selezionata. Nel display compare il valore nominale di temperatura.

### 29.2 Pre-raffreddamento del rotore

Per una rapida preraffreddazione del rotore non carico e degli accessori è consigliabile effettuare un ciclo di centrifugazione con le impostazioni funzionamento continuo ed un numero di giri all'incirca del 20% del numero di giri massimo del rotore.

## 30 Riscaldamento (solo per centrifughe con opzione di riscaldamento/ raffreddamento)

Durante il processo di centrifuga, in caso di necessità, il vano di centrifugazione può essere riscaldato alla temperatura preimpostata.

Al fermo del rotore, il riscaldamento è spento.



Pericolo di combustione! La temperatura superficiale dell'elemento riscaldante nella camera di centrifugazione della centrifuga può raggiungere 500°C / 932°F. Non toccare l'elemento riscaldante.

Durante un ciclo di centrifugazione con una temperatura molto elevata (per es. +90°C), si surriscalda la parte interna del coperchio dell'apparecchio. In questo caso non toccare la parte interna del coperchio.

## 31 Accelerazione centrifuga relativa (RCF)

L'accelerazione centrifuga relativa (RCF) è indicata come un multiplo dell'accelerazione terrestre (g). È un valore numerico privo di unità e funge per paragonare le prestazioni di separazione de sedimentazione.

Il calcolo viene eseguito in base alla formula:

$$RCF = \left( \frac{RPM}{1000} \right)^2 \times r \times 1,118 \quad \Rightarrow \quad RPM = \sqrt{\frac{RCF}{r \times 1,118}} \times 1000$$

RCF = accelerazione centrifuga relativa

RPM = numero dei giri

r = raggio di centrifugazione in mm = distanza dal centro dell'asse di rotazione fino al fondo del recipiente di centrifugazione. Raggio di centrifugazione vedi al capitolo "Anhang/Appendix, Rotoren und Zubehör/Rotors and accessories".



L'accelerazione centrifuga relativa (RCF) dipende dal numero dei giri e dal raggio di centrifugazione.

### 32 Centrifugazione di sostanze o di miscele di sostanze con densità maggiore di 1,2 kg/dm<sup>3</sup>

In caso di centrifugazione con massimo numero di giri, la densità dei materiali o delle miscele di materiali non deve superare il valore di composizione di 1,2 kg/dm<sup>3</sup>.

Con sostanze o miscele di sostanze di densità maggiore, il regime di rotazione deve venire ridotto.

Il numero di giri consentito si calcola con la formula seguente:

$$\text{numero di giri ridotto (n}_{\text{red}}) = \sqrt{\frac{1,2}{\text{densità maggiore [kg/dm}^3]}} \times \text{regime massimo di rotazione [RPM]}$$

p.es.: regime massimo di rotazione RPM 4000, densità 1,6 kg/dm<sup>3</sup>

$$n_{\text{red}} = \sqrt{\frac{1,2 \text{ kg/dm}^3}{1,6 \text{ kg/dm}^3}} \times 4000 \text{ RPM} = 3464 \text{ RPM}$$

Se in casi eccezionali viene superato il carico massimo indicato sul gancio, il regime di rotazione deve essere ridotto.

Il numero di giri consentito si calcola con la formula seguente:

$$\text{numero di giri ridotto (n}_{\text{red}}) = \sqrt{\frac{\text{carico massimo [g]}}{\text{carico effettivo [g]}}} \times \text{regime massimo di rotazione [RPM]}$$

p.es.: regime massimo di rotazione RPM 4000, carico massimo 350 g, carico effettivo 300 g

$$n_{\text{red}} = \sqrt{\frac{300 \text{ g}}{350 \text{ g}}} \times 4000 \text{ RPM} = 3703 \text{ RPM}$$

In caso di dubbio, rivolgersi al costruttore per maggiori informazioni.

### 33 Riconoscimento del rotore

Con l'inizio di ogni corsa di centrifugazione avviene il riconoscimento del rotore installato.

Dopo una sostituzione del rotore, il ciclo di centrifugazione si interrompe dopo il riconoscimento del rotore. Vengono visualizzati il Rotorcode (R xx) e il numero di giri massimo (n-max=xxxxx) del rotore.



L'ulteriore utilizzo della centrifuga è possibile solo dopo avere aperto una volta il coperchio.

Se il numero di giri massimo del rotore utilizzato è inferiore al numero di giri impostato, la velocità viene limitata al numero di giri massimo del rotore.

### 34 Sblocco di emergenza

In caso di una caduta di tensione, il coperchio non può essere sbloccato a motore. Deve essere effettuata manualmente uno sblocco di emergenza.



Per lo sblocco di emergenza, disconnettere la centrifuga dalla rete elettrica. Negli apparecchi a collegamento fisso, disinserire l'interruttore di rete dell'installazione dell'edificio per interrompere l'alimentazione di rete dell'apparecchio e assicurare contro un reinserimento, per es. chiudendo a chiave l'interruttore.

Aprire il coperchio solo con l'arresto del rotore.

Vedere illustrazione alla pagina 2.

- Disinserire l'interruttore di rete sul pannello anteriore (posizione interruttore "0").
- Guardare attraverso la finestra presente nel coperchio per assicurarsi che il rotore sia fermo.
- Introdurre la chiave per viti Allen nel foro (Fig. 1, A) e ruotarla con cautela di mezzo giro in senso orario, fino ad aprire il coperchio.
- Strappare la vite senza testa esagonale dal foro.
- Dopo la riaccensione della centrifuga, premere il tasto , in modo che la chiusura a mezzo di motore del coperchio riprenda nuovamente la posizione iniziale (apertura).

## 35 Pulizia e manutenzione



L'apparecchiatura può essere contaminata.



Prima della pulizia, staccare la presa di corrente. Negli apparecchi a collegamento fisso, disinserire l'interruttore di rete dell'installazione dell'edificio per interrompere l'alimentazione di rete dell'apparecchio e assicurare contro un reinserimento, per es. chiudendo a chiave l'interruttore.

Prima di iniziare un procedimento di pulizia e decontaminazione diverso da quello consigliato dal produttore, l'utilizzatore deve accertarsi presso il produttore che tale procedimento previsto non rechi danno all'apparecchio.

- Centrifughe, rotori e accessori non devono essere lavati in lavastoviglie.
- Si deve eseguire solo una pulizia manuale ed una disinfezione con liquido.
- La temperatura dell'acqua deve essere di 20 – 25°C.
- Devono essere utilizzati solo detersivi o disinfettanti che:
  - abbiano un campo di valori del pH che va da 5 a 8,
  - non contengano alcali caustici, perossidi, composti di cloro, acidi e soluzioni alcaline.
- Seguire attentamente le indicazioni speciali del produttore sull'impiego di detersivi e disinfettanti, al fine di evitare qualsiasi fenomeno di corrosione.

### 35.1 Centrifughe (scatola, coperchio e vano di centrifugazione)

#### 35.1.1 Cura e pulizia delle superfici

- Pulire regolarmente il corpo della centrifuga e la camera di centrifugazione e impiegare all'occorrenza sapone o un detersivo delicato e un panno umido. Ciò serve da un lato per l'igiene e dall'altro lato per evitare la corrosione causata da impurità incrostate.
- Ingredienti dei detersivi adatti: sapone, tensidi anionici, tensidi non ionici.
- Dopo l'impiego di detersivi, rimuovere i resti del detersivo pulendo di nuovo con un panno umido.
- Le superfici devono essere asciugate subito dopo la pulizia.
- In caso di formazione di acqua di condensa, asciugare la camera di centrifugazione pulendola con un panno assorbente.
- Spalmare sulla guarnizione di gomma della camera di centrifugazione, frizionando leggermente, polvere di talco o una sostanza per la cura della gomma.
- Controllare una volta l'anno se il vano di centrifugazione presenta danneggiamenti.



Se vengono stabiliti danni rilevanti per la sicurezza, la centrifuga non deve essere più messa in funzione. In questo caso si deve contattare il servizio assistenza clienti.

#### 35.1.2 Disinfezione delle superfici

- In presenza di materiale infettivo nella camera di centrifugazione si deve disinfettarla immediatamente.
- Ingredienti dei disinfettanti adatti: etanolo, alcol n proclitico, etilexanolo, tensidi anionici, inibitori di corrosione.
- Dopo l'impiego di disinfettanti, rimuovere i resti del disinfettante pulendo di nuovo con un panno umido.
- Le superfici devono essere asciugate subito dopo la disinfezione.

#### 35.1.3 Rimuovere contaminazioni radioattive

- La sostanza deve essere certificata in modo speciale per rimuovere contaminazioni radioattive.
- Ingredienti di sostanze adatte alla rimozione di contaminazioni radioattive: tensidi anionici, tensidi non ionici, etanolo poliidrato.
- Dopo aver rimosso le contaminazioni radioattive, rimuovere i resti della sostanza pulendo di nuovo con un panno umido.
- Le superfici devono essere asciugate, subito dopo la rimozione delle contaminazioni radioattive.

## 35.2 Rotori ed accessori

### 35.2.1 Pulizia e cura

- Per prevenire corrosione e alterazioni dei materiali, i rotori e l'accessorio devono essere regolarmente puliti con sapone o con un detergente delicato e con un panno umido. Si consiglia la pulizia almeno una volta la settimana. La sporcizia deve essere subito rimossa.
- Ingredienti dei detergenti adatti:  
sapone, tensidi anionici, tensidi non ionici.
- Dopo l'impiego di detergenti, rimuovere i resti del detergente, risciacquando con acqua (solo al di fuori della centrifuga) o ripulendo con un panno umido.
- I rotori e gli accessori devono essere asciugati immediatamente dopo la pulizia.
- I rotor ad angolo, i contenitori e i supporti in alluminio devono essere ingrassati leggermente con grasso privo d'acidi come ad esempio vaselina quando sono ben asciutti.
- Nei sistemi di sicurezza biologici (Per quanto riguarda i sistemi biologici di sicurezza fornibili, rimandiamo al capitolo "Anhang/Appendix, Rotoren und Zubehör/Rotors and accessories") gli anelli di guarnizione devono essere controllati e puliti periodicamente (ogni settimana). In presenza di crepe, parti fragili o logorio, l'anello di tenuta deve essere subito sostituito. Dopo ogni pulizia strofinare leggermente gli anelli di guarnizione con della polvere di talco oppure con una sostanza per la cura della gomma.
- Per evitare la corrosione causata dall'umidità tra il rotore e l'albero motore, si deve provvedere almeno una volta al mese di smontare il rotore, pulirlo e di lubrificare leggermente l'albero motore.
- I rotor e gli elementi accessori devono essere verificati settimanalmente per quanto riguarda il loro stato di usura ed i danneggiamenti da corrosione.

Con i motori di smorzamento devono essere verificati soprattutto il settore dei perni di supporto e per i ganci le scanalature, verificare inoltre l'eventuale presenza di incrinature nel fondo.

Esempio: Incrinatura nel settore della scanalatura.

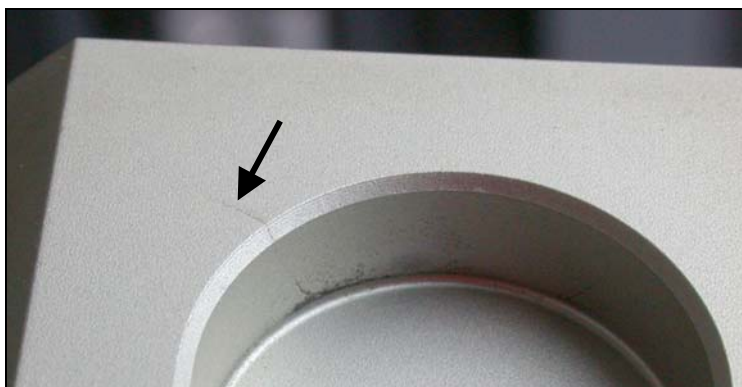

Rotori ed accessori non devono essere più utilizzati se presentano consumo o corrosione.

- Verificare settimanalmente la posizione del rotore.

### 35.2.2 Disinfezione

- Se del materiale infetto viene a contatto con i rotor o con gli accessori, allora si deve eseguire una disinfezione adeguata.
- Ingredienti dei disinfettanti adatti:  
etanolo, alcol n proclitico, etilexanolo, tensidi anionici, inibitori di corrosione.
- Dopo l'impiego di disinfettanti, rimuovere i resti del disinfettante, risciacquando con acqua (solo al di fuori della centrifuga) o ripulendo con un panno umido.
- I rotor e gli accessori devono essere asciugati immediatamente dopo la disinfezione.

### 35.2.3 Rimuovere contaminazioni radioattive

- La sostanza deve essere certificata in special modo per rimuovere contaminazioni radioattive.
- Ingredienti di sostanze adatte alla rimozione di contaminazioni radioattive:  
tensidi anionici, tensidi non ionici, etanolo poliidrato.
- Dopo la rimozione delle contaminazioni radioattive, rimuovere la sostanza, risciacquando con acqua (solo al di fuori della centrifuga) o ripulendo con un panno umido.
- I rotor e gli accessori devono essere asciugati subito dopo la rimozione delle contaminazioni radioattive.

### 35.2.4 Perni di trascinamento

In rotori oscillanti, i perni di trascinamento devono essere lubrificati regolarmente (Grasso lubrificante Hettich no. d'ord. 4051) per consentire un'oscillazione equilibrata dei ganci.

### 35.2.5 Rotori ed accessori con limitata durata di impiego

L'impiego di particolari rotori, ganci ed elementi accessori è limitato nel tempo.

Questi sono contrassegnati con la quantità max. di cicli di funzionamento o dalla data di scadenza ed il numero massimo di cicli di funzionamento o solo con la data di scadenza, p.es.:

- "einsetzbar bis Ende: IV. Quartal 2011 / usable until end of: IV. trimestre 2011" (utilizzabile fino alla fine: IV. trimestre 2011) o
- "einsetzbar bis Ende Monat/Jahr: 10/2011 / usable until end of month/year: 10/2011" (utilizzabile fino a fine mese/anno: 10/2011)
- "max. Laufzyklen / max. cycles: 40000". (Max. funzionamento cicli)



Per motivi di sicurezza l'impiego dei rotori, dei ganci e degli elementi di accessorio non è più ammesso, quando è raggiunta la quantità massima permessa dei cicli di funzionamento che è sopracontrassegnata o quando è raggiunta la data di scadenza sopracontrassegnata.

### 35.3 Mantenere in autoclave

Il seguente accessorio può essere sterilizzato in autoclave a 121°C / 250°F (20 min):

- Rotori basculanti
- Rotori angolari di alluminio
- Sospensioni in metallo
- Coperchio con chiusura ermetica anti-contaminazione
- Telaio
- Riduzioni

In caso di dubbio occorre informarsi presso la casa produttrice.

Non è possibile fare nessuna dichiarazione sul grado di sterilizzazione.



Il coperchio del rotore ed il contenitore devono essere staccati prima di essere riposti in autoclave.

La conservazione in autoclave accelera il processo di invecchiamento del materiale in plastica. Inoltre può causare variazioni di colore nel materiale in plastica.

Dopo il trattamento in autoclave consigliamo di sostituire le guarnizioni ad anello dei sistemi biologici di sicurezza.

### 35.4 Contenitori centrifuga

- In caso di mancanza di tenuta o dopo la rottura dei contenitori per centrifugazione, rimuovere completamente i frammenti dei contenitori, le schegge di vetro e il centrifugato fuoriuscito.
- Dopo la rottura di parti in vetro, sostituire gli inserti di gomma e i manicotti di plastica dei rotori.



Le schegge di vetro rimaste causano ulteriori rotture!

- Nel caso di materiale infettivo, bisogna provvedere immediatamente ad una disinfezione.

### 36 Guasti

Se non si riesce a eliminare l'errore seguendo le indicazioni della tabella guasti, informare il servizio assistenza clienti.

Si prega di indicare il tipo di centrifuga e il numero di serie. Entrambi i numeri sono visibili sulla targhetta di modello della centrifuga.

	<p>Esecuzione di un RESET RETE:</p> <ul style="list-style-type: none"> <li>- Disinserire l'interruttore di rete (posizione interruttore "0").</li> <li>- Attendere almeno 10 secondi quindi reinserire l'interruttore di rete (posizione interruttore "1").</li> </ul>
---	--

Visualizzazione/guasto		Causa	Eliminazione
Nessuna visualizzazione	---	Non c'è tensione. Scatto fusibile sovraccorrente (solo con i tipi 5005-08).	<ul style="list-style-type: none"> <li>- Controllare alimentatore elettrico.</li> <li>- Interruttore di rete ON.</li> </ul>
TACHO - ERROR	01	Tachimetro difettoso	<ul style="list-style-type: none"> <li>- Aprire il coperchio.</li> <li>- Disinserire l'interruttore di rete (posizione interruttore "0").</li> <li>- Attendere per almeno 10 secondi.</li> <li>- Girare energicamente a mano il rotore.</li> <li>- Reinserrire l'interruttore di rete (posizione interruttore "1"). Durante l'inserimento il rotore deve girare</li> </ul>
	02	Rotore non installato Motore, convertitore, azionatore difettosi.	
IMBALANCE / UNWUCHT	---	Il rotore è caricato in modo non uniforme.	<ul style="list-style-type: none"> <li>- Aprire il coperchio.</li> <li>- Controllare il caricamento del rotore, vedere il capitolo "Carico del rotore".</li> <li>- Ripetere il ciclo di centrifugazione.</li> </ul>
CONTROL - ERROR	04, 06 - 09	Errore blocco coperchio, ovvero chiusura coperchio.	<ul style="list-style-type: none"> <li>- Esecuzione di un RESET RETE.</li> </ul>
N > MAX	05	N° giri eccedente	
N < MIN	13	N° giri insufficiente	
ROTORCODE	10	Errore codifica rotore	
MAINS INTERRUPT	---	Interruzione di rete durante il ciclo di centrifugazione. (Il ciclo di centrifugazione non viene terminato.)	<ul style="list-style-type: none"> <li>- Aprire il coperchio.</li> <li>- Premere tasto <b>START</b>.</li> <li>- All'occorrenza ripetere il ciclo di centrifugazione.</li> </ul>
VERSIONS-ERROR	12	Non c'è corrispondenza tra i componenti elettronici	<ul style="list-style-type: none"> <li>- Esecuzione di un RESET RETE.</li> </ul>
SER I/O - ERROR	30 - 38	Errore/guasto interfaccia	
° C * - ERROR	50 - 56, 58	Errore/guasto raffreddamento	
LOCK - ERROR	57	Errore/guasto blocco programma	
FU / CCI - ERROR	60 - 83	Errore/guasto controllo motore	
CONTROL-ERROR	26, 90 - 95, 97 - 99	Errore/guasto lato comandi	
N > ROTOR-MAX	96	Il numero di giri nel programma selezionato è superiore al numero di giri massimo del rotore (n-max-Rotor).	<ul style="list-style-type: none"> <li>- Verificare e correggere la velocità nel programma selezionato.</li> </ul>
		Il rotore è stato cambiato. Il rotore installato ha un numero di giri superiore del precedente e non è stato ancora riconosciuto.	<ul style="list-style-type: none"> <li>- Impostare un numero di giri massimo superiore a quello del rotore precedentemente utilizzato. Premere il tasto <b>START</b> per effettuare il riconoscimento del rotore, vedi capitolo "Riconoscimento del rotore".</li> </ul>

### 37 Rispedizione di apparecchi

Se l'apparecchio o uno dei suoi accessori viene rispedito alla ditta Andreas Hettich GmbH & Co. KG, esso deve essere prima decontaminato e pulito per la tutela di persone, ambiente e materiale.

Ci riserviamo la facoltà di accettare apparecchi o accessori contaminati.

Eventuali costi di pulizia e disinfezione verranno fatturati al cliente.

Contiamo a questo riguardo sulla vostra comprensione.

### 38 Smaltimento

Prima dello smaltimento, l'apparecchiatura deve essere decontaminata e pulita con lo scopo di proteggere le persone, l'ambiente e il materiale.

Per lo smaltimento dell'apparecchio osservare le rispettive norme di legge.

Ai sensi della direttiva 2002/96/CE (RAEE) tutti gli apparecchi forniti dopo il 13/08/2005 non possono più essere smaltiti con i rifiuti domestici. Questo apparecchio appartiene alla categoria 8 (Dispositivi medicali) ed è classificato nel settore Business-to-Business.













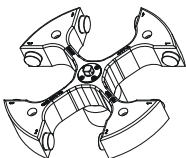
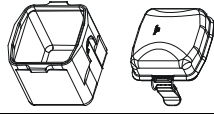

Il simbolo della pattumiera cancellata con una croce indica che l'apparecchio non deve essere smaltito con i rifiuti domestici.











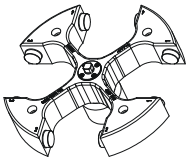
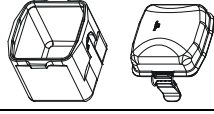





Le norme per lo smaltimento possono essere differenti nei singoli paesi UE. In caso di necessità rivolgersi al proprio rivenditore.











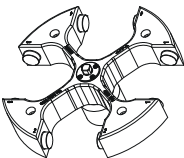
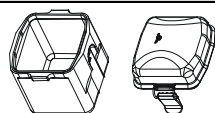
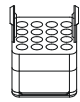

39 Anhang / Appendix

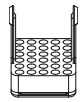









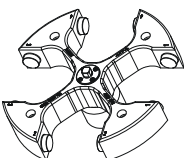
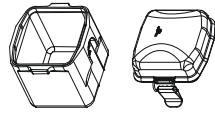
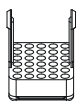

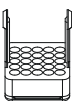

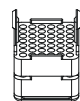
39.1 Rotoren und Zubehör / Rotors and accessories

4174		5052 + 5057							
<p><b>Ausschwingrotor 4-fach / Swing out rotor 4-times</b></p>  <p>∠ 90°</p>									
		mit Bioabdichtung / with bio-containment <sup>9)</sup>							
		4213		4213-93			4214		
									
		0501	0578	0553	0501	0501	0501	0501	
									
Kapazität / capacity	ml	6	7	4,5 - 5	5		2,7 - 3	7,5 - 8,5	8,5 - 10
Maße / dimensions	∅ x L mm	12 x 82	12 x 100	11 x 92	12 x 75	12 x 82	11 x 66	15 x 92	16 x 100
Anzahl p. Rotor / number p. rotor		192	192	192	192		192	120	120
Drehzahl / speed	RPM	4500							
RZB / RCF	<sup>2)</sup>	5003							
Radius / radius	mm	221							
 9 (97%)	sec	125							
 9	sec	197							
Temperatur / temperature	°C <sup>1)</sup>	-1							

4174		5052 + 5057								
<p><b>Ausschwingrotor 4-fach / Swing out rotor 4-times</b></p>  <p>∠ 90°</p>										
		mit Bioabdichtung / with bio-containment <sup>9)</sup>								
		4214		4214-93			4215		4216	4218
										
		0518		0519	---	0521	0523			
										
Kapazität / capacity	ml	10	15	4,5 - 5	4 - 7	25	30	50	100	
Maße / dimensions	∅ x L mm	15 x 102	17 x 100	15 x 75	16 x 75	24 x 100	25 x 110	34 x 100	44 x 115	
Anzahl p. Rotor / number p. rotor		120	120	120	120	44	44	24	16	
Drehzahl / speed	RPM	4500								
RZB / RCF	<sup>2)</sup>	5003								
Radius / radius	mm	221								
 9 (97%)	sec	125								
 9	sec	197								
Temperatur / temperature	°C <sup>1)</sup>	-1								











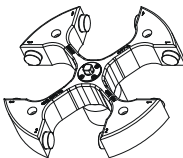

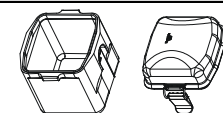
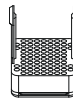
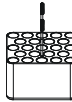
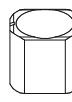
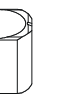
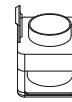
- |  |  |
|--|--|
| <p>1) Tiefste erreichbare Temperatur bei maximaler Drehzahl, 1 h Laufzeit und 20°C Raumtemperatur</p> <p>2) Zentrifugiergefäße aus Glas nur belastbar bis RZB 4000</p> <p>9) Nach DIN EN 61010, Teil 2 – 020. Die Hinweise für Bio-Sicherheitssysteme in den Kapiteln "Sicherheitshinweise" und "Pflege und Wartung" beachten.</p> | <p>1) Lowest possible temperature during maximum speed, 1 h running time and 20°C ambient temperature</p> <p>2) Centrifuge containers of glass will not stand RCF values exceeding 4000</p> <p>9) In conformity with DIN EN 61010, part 2 – 020. Observe the notes for bio safety systems in chapters "Notes on safety" and "Maintenance and servicing".</p> |
|--|--|

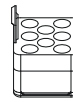
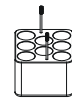

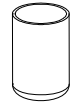

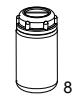
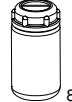





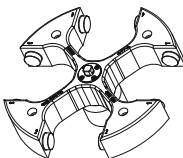

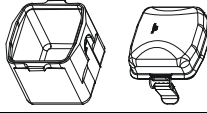
4174		5052 + 5057						
<b>Ausschwingrotor 4-fach / Swing out rotor 4-times</b>    90°								
		mit Bioabdichtung / with bio-containment 9)						
		4220		4222		4222-93		
								
								
Kapazität / capacity	ml	9 - 10	12	7	4 - 7	5	2,6 - 3,4	
Maße / dimensions	∅ x L	mm	16 x 92	17 x 100	12 x 100	13 x 100	12 x 75	13 x 65
Anzahl p. Rotor / number p. rotor		64	64	120	120	120	120	
Drehzahl / speed	RPM	4500						
RZB / RCF		5003						
Radius / radius	mm	221						
 9 (97%)	sec	125						
 9	sec	197						
Temperatur / temperature	°C <sup>1)</sup>	-1						

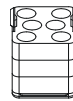
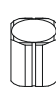
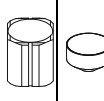
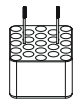
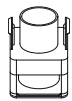
4174		5052 + 5057								
<b>Ausschwingrotor 4-fach / Swing out rotor 4-times</b>    90°										
		mit Bioabdichtung / with bio-containment 9)								
		4222-93	4223		4223-93	4224	4225			
										
										
Kapazität / capacity	ml	1,6 - 5	9	8	12	4 - 7	4	1,5	2	
Maße / dimensions	∅ x L	mm	13 x 75	14 x 100	16 x 125	16 x 101	16 x 75	10 x 88	11 x 38	11 x 38
Anzahl p. Rotor / number p. rotor		120	100	100	100	100	252	336	336	
Drehzahl / speed	RPM	4500	4500	4500	4500	4500	4500	4500	4500	
RZB / RCF		5003	5003	5003	5003	5003	5003	5094	5094	
Radius / radius	mm	221	221	221	221	221	221	225	225	
 9 (97%)	sec	125								
 9	sec	197								
Temperatur / temperature	°C <sup>1)</sup>	-1								











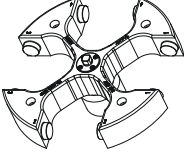

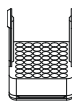
1) Tiefste erreichbare Temperatur bei maximaler Drehzahl, 1 h Laufzeit und 20°C Raumtemperatur  
 2) Zentrifugiergefäße aus Glas nur belastbar bis RZB 4000  
 9) Nach DIN EN 61010, Teil 2 – 020. Die Hinweise für Bio-Sicherheitssysteme in den Kapiteln "Sicherheitshinweise" und "Pflege und Wartung" beachten.











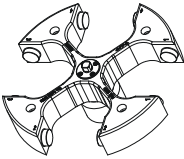

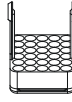
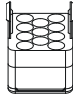
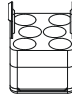
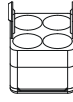
1) Lowest possible temperature during maximum speed, 1 h running time and 20°C ambient temperature  
 2) Centrifuge containers of glass will not stand RCF values exceeding 4000  
 9) In conformity with DIN EN 61010, part 2 – 020. Observe the notes for bio safety systems in chapters "Notes on safety" and "Maintenance and servicing".

4174	5052 + 5057								
<b>Ausschwingrotor 4-fach / Swing out rotor 4-times</b>    	 mit Bioabdichtung / with bio-containment <sup>9)</sup>								
	4226	4232	4233		4238		4241	4245	
									
	Microtainer	0509	4234	0551	5127	---		0513	
									
Kapazität / capacity	ml	0,8	15	750	600	250	290	25	50
Maße / dimensions Ø x L	mm	8 x 45	17 x 120	93 x 137	93 x 134	62 x 122	62 x 137	25 x 90	29 x 115
Anzahl p. Rotor / number p. rotor		312	92	4	4	4	4	32	32
Drehzahl / speed	RPM	4500	4500	4500	4500	4500	4500	4500	4500
RZB / RCF	<sup>2)</sup>	5003	5184	5184	5184	5003	5003	5003	5184
Radius / radius	mm	221	229	229	229	221	221	221	269
 9 (97%)	sec							125	
 9	sec							197	
Temperatur / temperature	°C <sup>1)</sup>							-1	

4174	5052 + 5057				5052				
<b>Ausschwingrotor 4-fach / Swing out rotor 4-times</b>    	 mit Bioabdichtung / with bio-containment <sup>9)</sup>								
	4249	4258	4258 + 4449	SK 09.00	6322				
									
		0512	Corning		Corning				
									
Kapazität / capacity	ml	50	750	500	14	250			
Maße / dimensions Ø x L	mm	29 x 115	97 x 152	96 x 147	16,5 x 106	60 x 162			
Anzahl p. Rotor / number p. rotor		24	4	4	92	6			
Drehzahl / speed	RPM	4500	4500	4500	4500	4500			
RZB / RCF	<sup>2)</sup>	5094	5184	5184	5117	5003			
Radius / radius	mm	225	229	229	226	221			
 9 (97%)	sec							125	
 9	sec							197	
Temperatur / temperature	°C <sup>1)</sup>							-1	





- |  |  |
|--|--|
| <p>1) Tiefste erreichbare Temperatur bei maximaler Drehzahl, 1 h Laufzeit und 20°C Raumtemperatur</p> <p>2) Zentrifugiergefäße aus Glas nur belastbar bis RZB 4000</p> <p>3) Gefäß nur belastbar bis RZB 700</p> <p>8) Bei Temperaturen über 40 °C und/oder geringer Befüllung der Gefäße können sich diese verformen.</p> <p>9) Nach DIN EN 61010, Teil 2 – 020. Die Hinweise für Bio-Sicherheitssysteme in den Kapiteln "Sicherheitshinweise" und "Pflege und Wartung" beachten.</p> | <p>1) Lowest possible temperature during maximum speed, 1 h running time and 20°C ambient temperature</p> <p>2) Centrifuge containers of glass will not stand RCF values exceeding 4000</p> <p>3) tube will not stand RCF values exceeding 700</p> <p>8) At temperatures above 40 °C and/or poor filling of the tubes, these can go out of shape.</p> <p>9) In conformity with DIN EN 61010, part 2 – 020. Observe the notes for bio safety systems in chapters "Notes on safety" and "Maintenance and servicing".</p> |
|--|--|





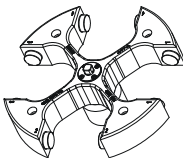
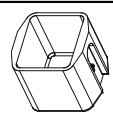
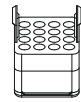
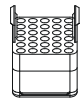
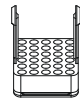

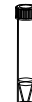

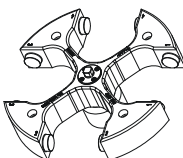
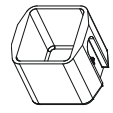
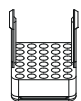

4174		4522-A							
<b>Ausschwingrotor 4-fach / Swing out rotor 4-times</b>    $\angle 90^\circ$									
		4213		4213-93			4214		
									
		0501	0578	4,5 - 5	0553	2,7 - 3	7,5 - 8,5	8,5 - 10	
									
Kapazität / capacity	ml	6	7	4,5 - 5	5	2,7 - 3	7,5 - 8,5	8,5 - 10	
Maße / dimensions $\varnothing \times L$	mm	12 x 82	12 x 100	11 x 92	12 x 75	11 x 66	15 x 92	16 x 100	
Anzahl p. Rotor / number p. rotor		192	192	192	192	192	120	120	
Drehzahl / speed	RPM	4500							
RZB / RCF	<sup>2)</sup>	5003							
Radius / radius	mm	221							
 9 (97%)	sec	125							
 9	sec	197							
Temperatur / temperature	$^\circ\text{C}^{1)}$	-1							

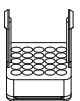
4174		4522-A								
<b>Ausschwingrotor 4-fach / Swing out rotor 4-times</b>    $\angle 90^\circ$										
		4214		4214-93		4215		4216	4218	
										
		0518			0519	---	0521	0523		
										
Kapazität / capacity	ml	10	15	4,5 - 5	4 - 7	25	30	50	100	
Maße / dimensions $\varnothing \times L$	mm	15 x 102	17 x 100	15 x 75	16 x 75	24 x 100	25 x 110	34 x 100	44 x 115	
Anzahl p. Rotor / number p. rotor		120	120	120	120	44	44	24	16	
Drehzahl / speed	RPM	4500								
RZB / RCF	<sup>2)</sup>	5003								
Radius / radius	mm	221								
 9 (97%)	sec	125								
 9	sec	197								
Temperatur / temperature	$^\circ\text{C}^{1)}$	-1								

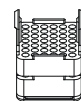
1) Tiefste erreichbare Temperatur bei maximaler Drehzahl, 1 h Laufzeit und 20°C Raumtemperatur  
 2) Zentrifugiergefäße aus Glas nur belastbar bis RZB 4000









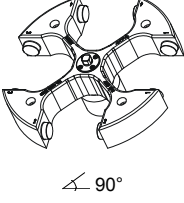

1) Lowest possible temperature during maximum speed, 1 h running time and 20°C ambient temperature  
 2) Centrifuge containers of glass will not stand RCF values exceeding 4000

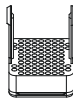
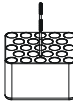
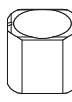
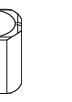
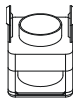
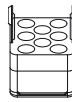
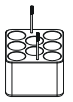



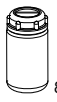

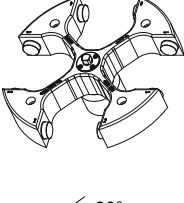

4174		4522-A							
<b>Ausschwingrotor 4-fach / Swing out rotor 4-times</b>    $\angle 90^\circ$									
		4220		4222		4222-93			
									
				0578		0553			
Kapazität / capacity	ml	9 - 10	12	7	4 - 7	5	2,6 - 3,4		
Maße / dimensions	Ø x L	16 x 92	17 x 100	12 x 100	13 x 100	12 x 75	13 x 65		
Anzahl p. Rotor / number p. rotor		64	64	120	120	120	120		
Drehzahl / speed	RPM	4500							
RZB / RCF		5003							
Radius / radius	mm	221							
9 (97%)	sec	125							
9	sec	197							
Temperatur / temperature	°C <sup>1)</sup>	-1							

4174		4522-A									
<b>Ausschwingrotor 4-fach / Swing out rotor 4-times</b>    $\angle 90^\circ$											
		4222-93		4223		4223-93		4224		4225	
											
				0500						2078	0536
Kapazität / capacity	ml	1,6 - 5	9	8	12	4 - 7	4	1,5	2		
Maße / dimensions	Ø x L	13 x 75	14 x 100	16 x 125	16 x 101	16 x 75	10 x 88	11 x 38	11 x 38		
Anzahl p. Rotor / number p. rotor		120	100	100	100	100	252	336	336		
Drehzahl / speed	RPM	4500									
RZB / RCF		5003									
Radius / radius	mm	221									
9 (97%)	sec	125									
9	sec	197									
Temperatur / temperature	°C <sup>1)</sup>	-1									

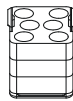
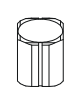
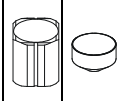
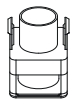
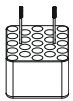
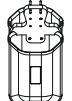
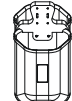
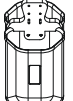
1) Tiefste erreichbare Temperatur bei maximaler Drehzahl, 1 h Laufzeit und 20°C Raumtemperatur  
 2) Zentrifugiergefäße aus Glas nur belastbar bis RZB 4000

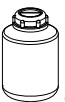
1) Lowest possible temperature during maximum speed, 1 h running time and 20°C ambient temperature  
 2) Centrifuge containers of glass will not stand RCF values exceeding 4000

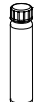
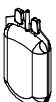
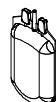
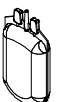









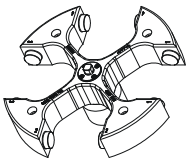



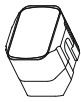
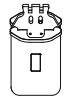
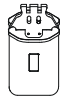
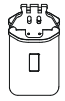
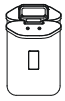
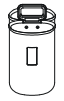

4174		4522-A							
<b>Ausschwingrotor 4-fach / Swing out rotor 4-times</b>  									
		4226	4232	4233		4238		4241	4245
									
		Microtainer	0509	4234	0551	5127	---	0513	
									
Kapazität / capacity	ml	0,8	15	750	600	250	290	25	50
Maße / dimensions	∅ x L	8 x 45	17 x 120	93 x 137	93 x 134	62 x 122	62 x 137	25 x 90	29 x 115
Anzahl p. Rotor / number p. rotor		312	92	4	4	4	4	32	32
Drehzahl / speed	RPM	4500	4500	4500	4500	4500	4500	4500	4500
RZB / RCF	<sup>2)</sup>	5003	5184	5184	5184	5003	5003	5003	5184
Radius / radius	mm	221	229	229	229	221	221	221	229
	9 (97%)					125			
	9					197			
Temperatur / temperature	°C <sup>1)</sup>					-1			



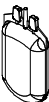



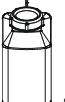
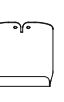



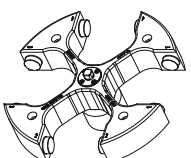

4174		4522-A					4524-A			
<b>Ausschwingrotor 4-fach / Swing out rotor 4-times</b>  										
		4249	4258	4258 + 4449		6322	SK 09.00	4529-O <sup>10)</sup>	4529-M <sup>10)</sup>	4529-U <sup>10)</sup>
										
			0512	Corning	Corning					
										
Kapazität / capacity	ml	50	750	500	250	14	500			
Maße / dimensions	∅ x L	29 x 115	97 x 152	96 x 147	60 x 162	16,5 x 106	---			
Anzahl p. Rotor / number p. rotor		24	4	4	4	138	8			
Drehzahl / speed	RPM	4500	4500	4500	4500	4500	4500			
RZB / RCF	<sup>2)</sup>	5094	5184	5184	5003	5117	5683			
Radius / radius	mm	225	229	229	221	226	251			
	9 (97%)					125				
	9					197				
Temperatur / temperature	°C <sup>1)</sup>					-1		10		

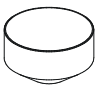
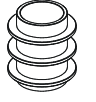
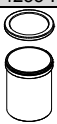
- |   |   |
|---|---|
| <p>1) Tiefste erreichbare Temperatur bei maximaler Drehzahl, 1 h Laufzeit und 20°C Raumtemperatur</p> <p>2) Zentrifugiergefäße aus Glas nur belastbar bis RZB 4000</p> <p>3) Gefäß nur belastbar bis RZB 700</p> <p>8) Bei Temperaturen über 40 °C und/oder geringer Befüllung der Gefäße können sich diese verformen.</p> <p>10) Darf nur in Gehänge 4524-A und beidseitig beladen werden. Bei Verwendung der Haltestifte darf die max. RZB 1000 nicht überschritten werden.</p> | <p>1) Lowest possible temperature during maximum speed, 1 h running time and 20°C ambient temperature</p> <p>2) Centrifuge containers of glass will not stand RCF values exceeding 4000</p> <p>3) tube will not stand RCF values exceeding 700</p> <p>8) At temperatures above 40 °C and/or poor filling of the tubes, these can go out of shape.</p> <p>10) May only be used in bucket 4524-A and with both sides loaded. If the holding pins are used the max. RCF of 1000 may not be exceeded.</p> |
|---|---|

	Position der Haltestifte	Abstand der Haltestifte vom Einsatzboden (innen)
4529-O	oben	199,5 mm
4529-M	Mitte	182,0 mm
4529-U	unten	164,5 mm

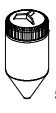









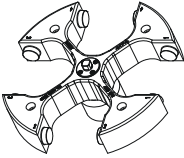

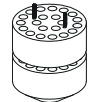



	Position of the holding pins	Distance of the holding pins from the bottom of the inserts (inside)
4529-O	upper section	199.5 mm
4529-M	middle section	182.0 mm
4529-U	lower section	164.5 mm











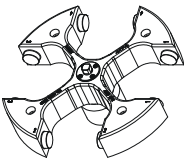

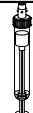
4174	4524-A				4546-A	4591-A	4595-A		
<b>Ausschwingrotor 4-fach / Swing out rotor 4-times</b>    									
	Baxter/ 4525	Biopack/ 4525	Fenwal 4525 6)	4592-A	4559-H/ 4559-N	4592-A	4596		
									
	2 x 4526	2 x 4527	2 x 4528	4-fach/ 4-times	1-fach/ 1-times	4-fach/4-times	4-fach/ 4-times	0550	4597
									
Kapazität / capacity ml	500	500	500	500   750	450	500   450	2000	100	
Maße / dimensions Ø x L mm	----	----	----	----	----	----	180x150x100	----	
Anzahl p. Rotor / number p. rotor	8	8	8	8	8	8	4	16	
Drehzahl / speed RPM	4500	4500	4500	4500	4500	4500	3500	1000	
RZB / RCF	5683	5683	5683	5683	5479	5705	5569	272	
Radius / radius mm	251	251	251	251	242	252	246	243	
 9 (97%) sec						125			
 9 sec						197			
Temperatur / temperature °C <sup>1)</sup>						10			
						-8			

4174	4579-A	4579-A + 4255 / 4255-P 4)						
<b>Ausschwingrotor 4-fach / Swing out rotor 4-times</b>    								
				4449	4430			
								
		4255 / 4255-P 4)	0512	4239	Corning		Nalgene®	Nunc®
								
Kapazität / capacity ml	1000	750	1000	500	250	175	200	
Maße / dimensions Ø x L mm	98 x 138	97 x 152	96 x 176	96 x 147	60 x 162	61,5 x 144	60 x 130	
Anzahl p. Rotor / number p. rotor	4	4	4	4	4	4	4	
Drehzahl / speed RPM	4500							
RZB / RCF	5501							
Radius / radius mm	243							
 9 (97%) sec	125							
 9 sec	197							
Temperatur / temperature °C <sup>1)</sup>	-11							

- 1) Tiefste erreichbare Temperatur bei maximaler Drehzahl, 1 h Laufzeit und 20°C Raumtemperatur (nur bei Kühlzentrifuge)
- 4) 4255-P: spezielle Oberflächenbehandlung für höchste hygienische Ansprüche
- 5) 4255 nicht mit Deckel verschließbar
- 6) Sowie Macopharma, Terumo, Kawasumi
- 8) Bei Temperaturen über 40 °C und/oder geringer Befüllung der Gefäße können sich diese verformen.
- 11) Maximale Beladung 800g. Bei einer Beladung über 800g muss die Drehzahl reduziert werden, siehe Beschriftung auf dem Becher. Berechnung der reduzierten Drehzahl siehe Kapitel "Zentrifugation von Stoffen oder Stoffgemischen mit einer höheren Dichte als 1,2 kg/dm<sup>3</sup>".

- 1) Lowest possible temperature during maximum speed, 1 h running time and 20°C ambient temperature (only with cooling centrifuges)
- 4) 4255-P: special surface treatment for highest hygienic requirements
- 5) 4255 cannot be closed with the lid
- 6) as soon as Macopharma, Terumo, Kawasumi
- 8) At temperatures above 40 °C and/or poor filling of the tubes, these can go out of shape.
- 11) Maximum load 800g. With a load higher than 800g the speed has to be reduced, see label on the bucket. Calculation of the reduced speed see chapter "Centrifugation of materials or mixtures of materials with a density higher than 1.2 kg/dm<sup>3</sup>".





<p><b>4174</b></p> <p><b>Ausschwingrotor 4-fach / Swing out rotor 4-times</b></p>  <p>∠ 90°</p>	<p><b>4579-A + 4255 / 4255-P 4)</b></p> 											
	4432		4433					4434				
												
	2078	0536		0578			0500	2079	0518			
												
Kapazität / capacity	ml	1,5	2,0	5	7	2,7 - 3	4,5 - 5	9	10	15		
Maße / dimensions	∅ x L	mm	11 x 38	12 x 75	12 x 100	11 x 66	11 x 92	14 x 100	17 x 70	17 x 100		
Anzahl p. Rotor / number p. rotor		168	120	120	120	120	120	76	76	76		
Drehzahl / speed	RPM	4500	4500	4500	4500	4500	4500	4500	4500	4500		
RZB / RCF	<sup>2)</sup>	5003	4935	4935	4935	4935	4935	5094	5094	5094		
Radius / radius	mm	221	218	218	218	218	218	225	225	225		
	9 (97%)									125		
	9									197		
Temperatur / temperature	°C <sup>1)</sup>									-11		





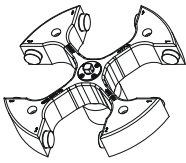

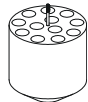
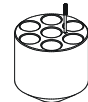
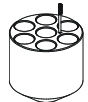
<p><b>4174</b></p> <p><b>Ausschwingrotor 4-fach / Swing out rotor 4-times</b></p>  <p>∠ 90°</p>	<p><b>4579-A + 4255 / 4255-P 4)</b></p> 									
	4434									
										
										
Kapazität / capacity	ml	10	10	8	4 - 5,5	9 - 10	4 - 7	8,5 - 10		
Maße / dimensions	∅ x L	mm	15 x 102	16 x 80	16 x 81	15 x 75	16 x 92	16 x 75	16 x 100	
Anzahl p. Rotor / number p. rotor		76	76	76	76	76	76	76	76	
Drehzahl / speed	RPM	4500								
RZB / RCF	<sup>2)</sup>	5094								
Radius / radius	mm	225								
	9 (97%)									125
	9									197
Temperatur / temperature	°C <sup>1)</sup>									-11

- 1) Tiefste erreichbare Temperatur bei maximaler Drehzahl, 1 h Laufzeit und 20°C Raumtemperatur (nur bei Kühlzentrifuge)
- 2) Zentrifugiergefäße aus Glas nur belastbar bis RZB 4000
- 4) 4255-P: spezielle Oberflächenbehandlung für höchste hygienische Ansprüche
- 5) 4255 nicht mit Deckel verschließbar

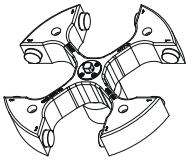
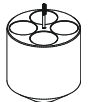
- 1) Lowest possible temperature during maximum speed, 1 h running time and 20°C ambient temperature (only with cooling centrifuges)
- 2) Centrifuge containers of glass will not stand RCF values exceeding 4000
- 4) 4255-P: special surface treatment for highest hygienic requirements
- 5) 4255 cannot be closed with the lid

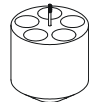
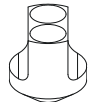









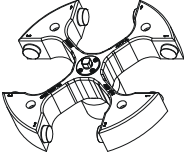

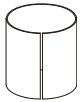
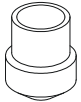

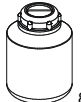
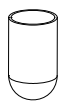





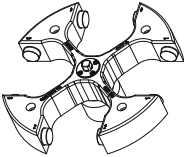

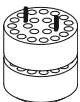

4174		4579-A + 4255 / 4255-P 4)									
<b>Ausschwingrotor 4-fach / Swing out rotor 4-times</b>    90°											
						0509				0519	
Kapazität / capacity	ml	2,6 – 3,4	4,9	1,6 - 5	4 – 7	15	25	30	25		
Maße / dimensions Ø x L	mm	13 x 65	13 x 90	13 x 75	13 x 100	17 x 120	25 x 90	25 x 110	24 x 100		
Anzahl p. Rotor / number p. rotor		84	84	84	84	48	28	28	28		
Drehzahl / speed	RPM	4500	4500	4500	4500	4500	4500	4500	4500		
RZB / RCF	2)	4935	4935	4935	4935	5207	5026	5026	4845		
Radius / radius	mm	218	218	218	218	230	222	222	214		
 9 (97%)	sec	125									
 9	sec	197									
Temperatur / temperature	°C 1)	-11									

4174		4579-A + 4255 / 4255-P 4)													
<b>Ausschwingrotor 4-fach / Swing out rotor 4-times</b>    90°															
														4439	
				0521		Falcon®		Falcon®		0513		0526		---	
Kapazität / capacity	ml	50	225	175	50	100	290	250							
Maße / dimensions Ø x L	mm	34 x 100	61 x 137	61 x 118	29 x 115	44 x 100	62 x 137	61 x 122							
Anzahl p. Rotor / number p. rotor		16	4	4	20	8	4	4							
Drehzahl / speed	RPM	4500	4500	4500	4500	4500	4500	4500							
RZB / RCF	2)	4890	5501	5501	5207	4867	5320	5320							
Radius / radius	mm	216	243	243	230	215	235	235							
 9 (97%)	sec	125													
 9	sec	197													
Temperatur / temperature	°C 1)	-11													









- 1) Tiefste erreichbare Temperatur bei maximaler Drehzahl, 1 h Laufzeit und 20°C Raumtemperatur (nur bei Kühlzentrifuge)
- 2) Zentrifugiergefäße aus Glas nur belastbar bis RZB 4000
- 3) Gefäß nur belastbar bis RZB 700
- 4) 4255-P: spezielle Oberflächenbehandlung für höchste hygienische Ansprüche
- 5) 4255 nicht mit Deckel verschließbar
- 8) Bei Temperaturen über 40 °C und/oder geringer Befüllung der Gefäße können sich diese verformen.

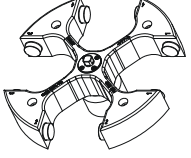
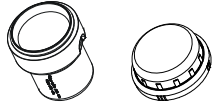
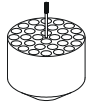









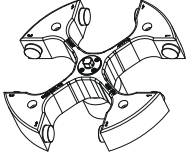

- 1) Lowest possible temperature during maximum speed, 1 h running time and 20°C ambient temperature (only with cooling centrifuges)
- 2) Centrifuge containers of glass will not stand RCF values exceeding 4000
- 3) tube will not stand RCF values exceeding 700
- 4) 4255-P: special surface treatment for highest hygienic requirements
- 5) 4255 cannot be closed with the lid
- 8) At temperatures above 40 °C and/or poor filling of the tubes, these can go out of shape.

4174		4579-A + 4255 / 4255-P 4)						
<b>Ausschwingrotor 4-fach / Swing out rotor 4-times</b>    ↙ 90°								
		4466	SK 39.93	SK 61.98				
								
		0551	0530					
		 8)						
Kapazität / capacity	ml	600	250	50				
Maße / dimensions Ø x L	mm	93 x 134	65 x 115	29 x 115				
Anzahl p. Rotor / number p. rotor		4	4	20				
Drehzahl / speed	RPM	4500	4500	4500				
RZB / RCF	2)	5501	5049	5003				
Radius / radius	mm	243	223	221				
 9 (97%)	sec	125						
 9	sec	197						
Temperatur / temperature	°C 1)	-11						

4174		4547-A + 5621							
<b>Ausschwingrotor 4-fach / Swing out rotor 4-times</b>    ↙ 90°									
				4449	4430		4432		
									
		0512	4239	Corning	Corning	Nalgene	Nunc	2078	0536
		 8)	 8)						
Kapazität / capacity	ml	750	1000	500	250	175	200	1,5	2,0
Maße / dimensions Ø x L	mm	97 x 152	96 x 176	96 x 147	60 x 162	61,5 x 144,3	60 x 130	11 x 38	11 x 38
Anzahl p. Rotor / number p. rotor		4	4	4	4	4	4	168	252
Drehzahl / speed	RPM	4500	4500	4500	4500	4500	4500	4500	4500
RZB / RCF	2)	5592	5592	5592	5592	5592	5592	5094	5094
Radius / radius	mm	247	247	247	247	247	247	225	225
 9 (97%)	sec	125							
 9	sec	197							
Temperatur / temperature	°C 1)	-9							

- |  |  |
|--|--|
| <p>1) Tiefste erreichbare Temperatur bei maximaler Drehzahl, 1 h Laufzeit und 20°C Raumtemperatur</p> <p>2) Zentrifugiergefäße aus Glas nur belastbar bis RZB 4000</p> <p>4) 4255-P: spezielle Oberflächenbehandlung für höchste hygienische Ansprüche</p> <p>8) Bei Temperaturen über 40 °C und/oder geringer Befüllung der Gefäße können sich diese verformen.</p> | <p>1) Lowest possible temperature during maximum speed, 1 h running time and 20°C ambient temperature</p> <p>2) Centrifuge containers of glass will not stand RCF values exceeding 4000</p> <p>4) 4255-P: special surface treatment for highest hygienic requirements</p> <p>8) At temperatures above 40 °C and/or poor filling of the tubes, these can go out of shape.</p> |
|--|--|

4174		4547-A + 5621										
<b>Ausschwingrotor 4-fach / Swing out rotor 4-times</b>    90°												
		4433				4434						
												
Kapazität / capacity	ml	5	7	2,7 - 3	4,5 - 5	9	10	10				
Maße / dimensions	∅ x L	mm	12 x 75	12 x 100	11 x 66	11 x 92	14 x 100	17 x 70	16 x 80			
Anzahl p. Rotor / number p. rotor			120	120	120	120	76	76	76			
Drehzahl / speed	RPM		4500	4500	4500	4500	4500	4500	4500			
RZB / RCF	<sup>2)</sup>		5026	5026	5026	5026	5184	5184	5184			
Radius / radius	mm		222	222	222	222	229	229	229			
 9 (97%)	sec	125										
 9	sec	197										
Temperatur / temperature	°C <sup>1)</sup>	-9										









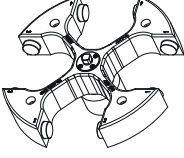
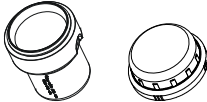
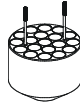
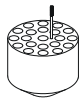
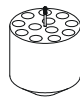
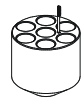

4174		4547-A + 5621															
<b>Ausschwingrotor 4-fach / Swing out rotor 4-times</b>    90°																	
		4434															
																	
Kapazität / capacity	ml	8	4 - 5,5	7,5 - 8,2	9 - 10	4 - 7	8	8,5 - 10	12								
Maße / dimensions	∅ x L	mm	16 x 81	15 x 75	15 x 92	16 x 92	16 x 75	16 x 125	16 x 100	16 x 101							
Anzahl p. Rotor / number p. rotor			76	76	76	76	76	76	76	76							
Drehzahl / speed	RPM		4500	4500	4500	4500	4500	4500	4500	4500							
RZB / RCF	<sup>2)</sup>		5184	5184	5184	5184	5184	5184	5184	5184							
Radius / radius	mm		229	229	229	229	229	229	229	229							
 9 (97%)	sec	125															
 9	sec	197															
Temperatur / temperature	°C <sup>1)</sup>	-9															





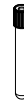





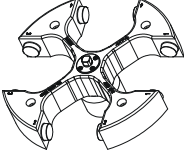

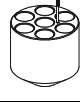
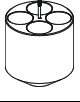
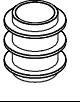

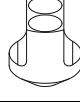
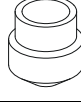
1) Tiefste erreichbare Temperatur bei maximaler Drehzahl, 1 h Laufzeit und 20°C Raumtemperatur

1) Lowest possible temperature during maximum speed, 1 h running time and 20°C ambient temperature

2) Zentrifugiergefäße aus Glas nur belastbar bis RZB 4000

2) Centrifuge containers of glass will not stand RCF values exceeding 4000

4174		4547-A + 5621								
<b>Ausschwingrotor 4-fach / Swing out rotor 4-times</b>    90°										
		4434		4435				4437	4438 + 0726	
										
		0518				0509		0519		
										
Kapazität / capacity	ml	10	15	2,6 – 3,4	4,9	1,6 – 5	4 – 7	15	25	
Maße / dimensions	∅ x L	15 x 102	17 x 100	13 x 65	13 x 90	13 x 75	13 x 100	17 x 120	24 x 100	
Anzahl p. Rotor / number p. rotor		76	76	84	84	84	84	48	28	
Drehzahl / speed	RPM	4500	4500	4500	4500	4500	4500	4500	4500	
RZB / RCF	<sup>2)</sup>	5184	5184	5026	5026	5026	5026	5298	4913	
Radius / radius	mm	229	229	222	222	222	222	234	217	
 9 (97%)	sec								125	
 9	sec								197	
Temperatur / temperature	°C <sup>1)</sup>								-9	

4174		4547-A + 5621								
<b>Ausschwingrotor 4-fach / Swing out rotor 4-times</b>    90°										
		4438		4439		4440		4441	4442	4443
										
		0521				0513	0526	5127		
									8)	
Kapazität / capacity	ml	25	30	50	225	175	50	100	250	
Maße / dimensions	∅ x L	25 x 90	25 x 110	34 x 100	61 x 137	61 x 118	29 x 115	44 x 100	62 x 122	
Anzahl p. Rotor / number p. rotor		28	28	16	4	4	20	8	4	
Drehzahl / speed	RPM	4500	4500	4500	4500	4500	4500	4500	4500	
RZB / RCF	<sup>2)</sup>	5117	5117	4981	5592	5592	5298	4958	5411	
Radius / radius	mm	226	226	220	247	247	234	219	239	
 9 (97%)	sec								125	
 9	sec								197	
Temperatur / temperature	°C <sup>1)</sup>								-9	

1) Tiefste erreichbare Temperatur bei maximaler Drehzahl, 1 h Laufzeit und 20°C Raumtemperatur











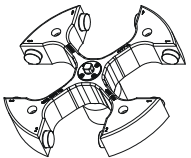

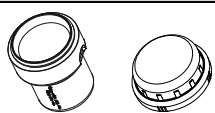
2) Zentrifugiergefäße aus Glas nur belastbar bis RZB 4000

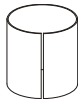
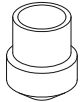

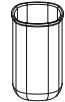
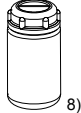

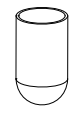

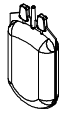
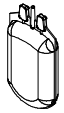
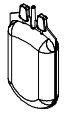



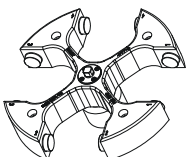

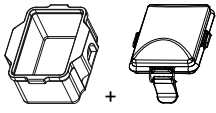
8) Bei Temperaturen über 40 °C und/oder geringer Befüllung der Gefäße können sich diese verformen.

1) Lowest possible temperature during maximum speed, 1 h running time and 20°C ambient temperature

2) Centrifuge containers of glass will not stand RCF values exceeding 4000







8) At temperatures above 40 °C and/or poor filling of the tubes, these can go out of shape.



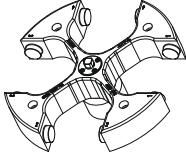

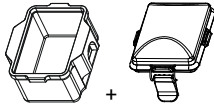
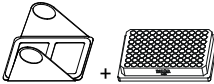

4174	4547-A + 5621				4523-A				
<b>Ausschwingrotor 4-fach / Swing out rotor 4-times</b>    									
	4443	4466	SK 39.93	SK 61.98	4516				
									
									
Kapazität / capacity	ml	290	600	250	50	500	750	1000	
Maße / dimensions	Ø x L	mm	62 x 137	93 x 134	65 x 115	29 x 115	---	---	---
Anzahl p. Rotor / number p. rotor		4	4	4	20	4	4	4	
Drehzahl / speed	RPM	4500	4500	4500	4500	4500	4500	4500	
RZB / RCF	<sup>2)</sup>	5411	5592	5139	5094	5637	5637	5705	
Radius / radius	mm	239	247	227	225	249	249	252	
 9 (97%)	sec							125	
 9	sec							197	
Temperatur / temperature	°C <sup>1)</sup>	-9				3			

4174	SK 06.07 + 5629								
<b>Ausschwingrotor 4-fach / Swing out rotor 4-times</b>    									
	4626								
		MTP	MTP	MS	CP	DWP	Microtest-platten / plate Terasaki	QP	
									
Maße / dimensions	Ø x L	mm	86x128x15	86x128x17,5	86x128x46	86x128x22	86x128x44,5	59x84x11	86x128x 83
Anzahl p. Rotor / number p. rotor		24	20	4	16	4	8	4	
Drehzahl / speed	RPM	4500	4500	4500	4500	4500	4500	4500	
RZB / RCF	<sup>2)</sup>	4324	4324	4324	4324	4324	4324	4324	
Radius / radius	mm	191	191	191	191	191	191	191	
 9 (97%)	sec							125	
 9	sec							197	
Temperatur / temperature	°C <sup>1)</sup>								

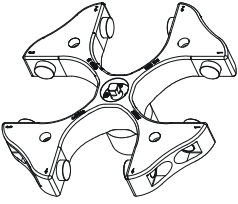
- |  |  |
|--|--|
| 1) Tiefste erreichbare Temperatur bei maximaler Drehzahl, 1 h Laufzeit und 20°C Raumtemperatur     | 1) Lowest possible temperature during maximum speed, 1 h running time and 20°C ambient temperature |
| 2) ZentrifugiergefäÙe aus Glas nur belastbar bis RZB 4000  | 2) Centrifuge containers of glass will not stand RCF values exceeding 4000                         |
| 8) Bei Temperaturen über 40 °C und/oder geringer Befüllung der GefäÙe können sich diese verformen. | 8) At temperatures above 40 °C and/or poor filling of the tubes, these can go out of shape.        |

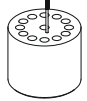
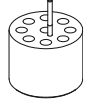
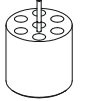
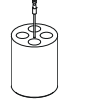
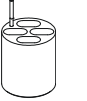
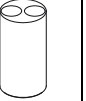
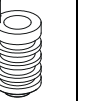







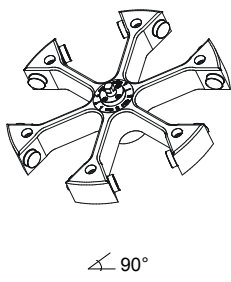
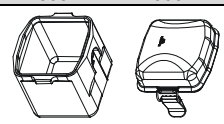

MTP Mikrotiterplatte / Microtitre plate	CP Kulturplatte / Culture plate	DWP Deep Well Platte / Deep well plate	MS Micronic System / Micronic system	QP Filterplatte / Filter plate
---	---------------------------------	--	--------------------------------------	--------------------------------

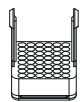
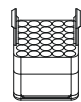









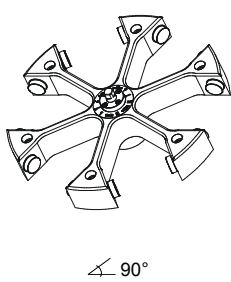
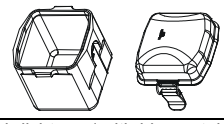

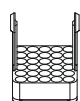
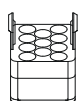
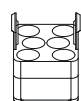
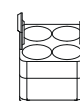
4174		SK 06.07 + 5629						
<b>Ausschwingrotor 4-fach / Swing out rotor 4-times</b>    								
		<b>4626 + 1485</b>  						
PCR-Platte 96-fach/ PCR-plate 96 times		PCR-Strips						
								
Kapazität / capacity	ml	---	0,2					
Maße / dimensions	∅ x L mm	82x124x20	---					
Anzahl p. Rotor / number p. rotor		4	48					
Drehzahl / speed	RPM	4500	4500					
RZB / RCF	<sup>2)</sup>	4324	4324					
Radius / radius	mm	191	191					
 9 (97%)	sec	125						
 9	sec	197						
Temperatur / temperature	°C <sup>1)</sup>							

SK 48.06-35 7)		SK 48.06-36							
<b>Ausschwingrotor 4-fach / Swing out rotor 4-times</b>    									
		SK 48.06-1	SK 48.06-2	SK 48.06-3	SK 48.06-4	SK 48.06-6	SK 48.06-7	SK 48.06-8	SK 48.06-9
									
Kapazität / capacity	ml	---	---	---	---	---	---	---	---
Maße / dimensions	∅ x L mm	11,5 x 75	14,5 x 70	18,5 x 91	25,5 x 118	21,5x42x118	42,5 x 186	49 x 173	49 x 230,5
Anzahl p. Rotor / number p. rotor		52	36	28	16	16	8	4	4
Drehzahl / speed	RPM	2800	2800	2800	2800	2800	2800	2800	2800
RZB / RCF		2375	2375	2375	2375	2375	2559	2559	2559
Radius / radius	mm	271	271	271	271	271	292	292	292
 9 (97%)	sec	---							
 9	sec	---							
 0	sec	---							
Temperatur / temperature	°C <sup>1)</sup>	7							

- 1) Tiefste erreichbare Temperatur bei maximaler Drehzahl, 1 h Laufzeit und 20°C Raumtemperatur
- 2) Zentrifugiergefäße aus Glas nur belastbar bis RZB 4000
- 7) nur lauffähig in Zentrifugen Typ SK 48.06-30

- 1) Lowest possible temperature during maximum speed, 1 h running time and 20°C ambient temperature
- 2) Centrifuge containers of glass will not stand RCF values exceeding 4000
- 7) only executable in centrifuges type SK 48.06-30

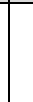
4176	5052 + 5057									
<b>Ausschwingrotor 6-fach / Swing out rotor 6-times</b>    ∠ 90°										
	mit Bioabdichtung / with bio-containment 9)									
	4213			4213-93			4214			
										
0501		0578		0507		0507		0507	0507	
										
Kapazität / capacity	ml	6	7	4,5 - 5	5	2,7 - 3	15	7,5 - 8,5	8,5 - 10	
Maße / dimensions	∅ x L	mm	12 x 82	12 x 100	11 x 92	12 x 75	11 x 66	17 x 100	15 x 92	16 x 100
Anzahl p. Rotor / number p. rotor		288	288	288	288	288	180	180	180	
Drehzahl / speed	RPM	4500								
RZB / RCF	<sup>2)</sup>	5818								
Radius / radius	mm	257								
 9 (97%)	sec	125								
 9	sec	197								
Temperatur / temperature	°C <sup>1)</sup>	14								

4176	5052 + 5057									
<b>Ausschwingrotor 6-fach / Swing out rotor 6-times</b>    ∠ 90°										
	mit Bioabdichtung / with bio-containment 9)									
	4214		4214-93		4215		4216	4218		
										
0518	0518	0518	0518	0519	---	0521	0523			
										
Kapazität / capacity	ml	10	15	4,5 - 5	4 - 7	25	30	50	100	
Maße / dimensions	∅ x L	mm	15 x 102	17 x 100	15 x 75	16 x 75	24 x 100	25 x 110	34 x 100	44 x 115
Anzahl p. Rotor / number p. rotor		180	180	180	180	66	66	36	24	
Drehzahl / speed	RPM	4500								
RZB / RCF	<sup>2)</sup>	5818								
Radius / radius	mm	257								
 9 (97%)	sec	125								
 9	sec	197								
Temperatur / temperature	°C <sup>1)</sup>	14								

1) Tiefste erreichbare Temperatur bei maximaler Drehzahl, 1 h Laufzeit und 20°C Raumtemperatur









2) Zentrifugiergefäße aus Glas nur belastbar bis RZB 4000

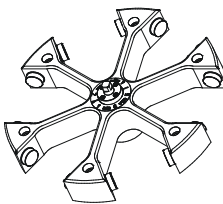

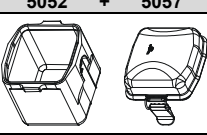
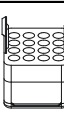
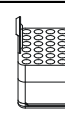
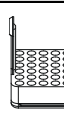



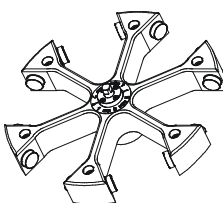

9) Nach DIN EN 61010, Teil 2 – 020. Die Hinweise für Bio-Sicherheitssysteme in den Kapiteln "Sicherheitshinweise" und "Pflege und Wartung" beachten.

1) Lowest possible temperature during maximum speed, 1 h running time and 20°C ambient temperature

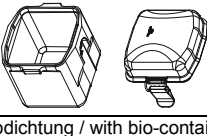
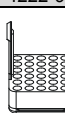
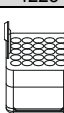
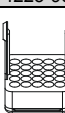
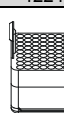
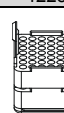
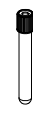
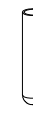
2) Centrifuge containers of glass will not stand RCF values exceeding 4000

9) In conformity with DIN EN 61010, part 2 – 020. Observe the notes for bio safety systems in chapters "Notes on safety" and "Maintenance and servicing".

4176		5052 + 5057						
<b>Ausschwingrotor 6-fach / Swing out rotor 6-times</b>    		 mit Bioabdichtung / with bio-containment <sup>9)</sup>						
		4220		4222		4222-93		
								
			0578		0553			
Kapazität / capacity	ml	9 - 10	12	7	4 - 7	5	2,6 - 3,4	
Maße / dimensions	∅ x L	mm	16 x 92	17 x 100	12 x 100	13 x 100	12 x 75	13 x 65
Anzahl p. Rotor / number p. rotor		96	96	180	180	180	180	
Drehzahl / speed	RPM	4500						
RZB / RCF	<sup>2)</sup>	5818						
Radius / radius	mm	257						
 9 (97%)	sec	125						
 9	sec	197						
Temperatur / temperature	°C <sup>1)</sup>	14						



4176		5052 + 5057								
<b>Ausschwingrotor 6-fach / Swing out rotor 6-times</b>    		 mit Bioabdichtung / with bio-containment <sup>9)</sup>								
		4222-93	4223			4223-93	4224	4225		
										
			0500					2078	0536	
Kapazität / capacity	ml	1,6 - 5	9	8	12	4 - 7	4	1,5	2	
Maße / dimensions	∅ x L	mm	13 x 75	14 x 100	16 x 125	16 x 101	16 x 75	10 x 88	11 x 38	11 x 38
Anzahl p. Rotor / number p. rotor		180	150	150	150	150	378	504	504	
Drehzahl / speed	RPM	4500								
RZB / RCF	<sup>2)</sup>	5818								
Radius / radius	mm	257	257	257	257	257	257	261	261	
 9 (97%)	sec	125								
 9	sec	197								
Temperatur / temperature	°C <sup>1)</sup>	14								

1) Tiefste erreichbare Temperatur bei maximaler Drehzahl, 1 h Laufzeit und 20°C Raumtemperatur  
 2) Zentrifugiergefäße aus Glas nur belastbar bis RZB 4000  
 9) Nach DIN EN 61010, Teil 2 – 020. Die Hinweise für Bio-Sicherheitssysteme in den Kapiteln "Sicherheitshinweise" und "Pflege und Wartung" beachten.



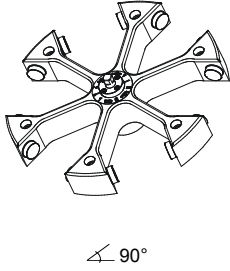
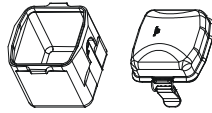

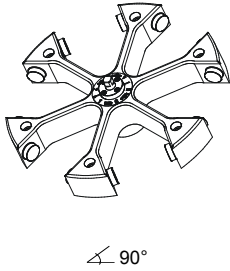
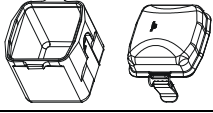





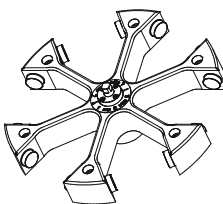
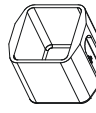

1) Lowest possible temperature during maximum speed, 1 h running time and 20°C ambient temperature  
 2) Centrifuge containers of glass will not stand RCF values exceeding 4000  
 9) In conformity with DIN EN 61010, part 2 – 020. Observe the notes for bio safety systems in chapters "Notes on safety" and "Maintenance and servicing".











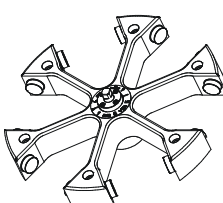

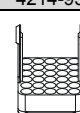
4176		5052 + 5057							
<b>Ausschwingrotor 6-fach / Swing out rotor 6-times</b>   ∠ 90°									
		mit Bioabdichtung / with bio-containment 9)							
		4226	4232	4233		4238		4241	4245
		Microtainer	0509	4234	0551	5127	---	0513	
Kapazität / capacity	ml	0,8	15	750	600	250	290	25	50
Maße / dimensions Ø x L	mm	8 x 45	17 x 120	93 x 137	93 x 134	62 x 122	62 x 137	25 x 90	29 x 115
Anzahl p. Rotor / number p. rotor		468	138	6	6	6	6	48	48
Drehzahl / speed	RPM	4500	4500	4500	4500	4500	4500	4500	4500
RZB / RCF	2)	5818	5999	5999	5999	5818	5818	5818	5999
Radius / radius	mm	257	265	265	265	257	257	257	265
	9 (97%)					125			
	9					197			
Temperatur / temperature	°C 1)					14			

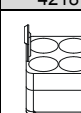
4176		5052 + 5057				5052		
<b>Ausschwingrotor 6-fach / Swing out rotor 6-times</b>   ∠ 90°								
		mit Bioabdichtung / with bio-containment 9)						
		4249	4258	4258 + 4449	SK 09.00	6322		
			0512	Corning		Corning		
Kapazität / capacity	ml	50	750	500	14	250		
Maße / dimensions Ø x L	mm	29 x 115	97 x 152	96 x 147	16,5 x 106	60 x 162		
Anzahl p. Rotor / number p. rotor		36	6	6	138	6		
Drehzahl / speed	RPM	4500	4500	4500	4500	4500		
RZB / RCF	2)	5909	5999	5999	5954	5818		
Radius / radius	mm	261	265	265	263	257		
	9 (97%)					125		
	9					197		
Temperatur / temperature	°C 1)					14		









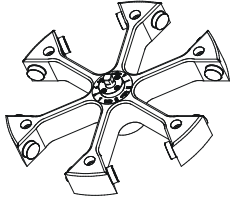
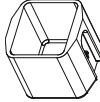

- |  |  |
|--|--|
| <p>1) Tiefste erreichbare Temperatur bei maximaler Drehzahl, 1 h Laufzeit und 20°C Raumtemperatur</p> <p>2) Zentrifugiergefäße aus Glas nur belastbar bis RZB 4000</p> <p>3) Gefäß nur belastbar bis RZB 700</p> <p>8) Bei Temperaturen über 40 °C und/oder geringer Befüllung der Gefäße können sich diese verformen.</p> <p>9) Nach DIN EN 61010, Teil 2 – 020. Die Hinweise für Bio-Sicherheitssysteme in den Kapiteln "Sicherheitshinweise" und "Pflege und Wartung" beachten.</p> | <p>1) Lowest possible temperature during maximum speed, 1 h running time and 20°C ambient temperature</p> <p>2) Centrifuge containers of glass will not stand RCF values exceeding 4000</p> <p>3) tube will not stand RCF values exceeding 700</p> <p>8) At temperatures above 40 °C and/or poor filling of the tubes, these can go out of shape.</p> <p>9) In conformity with DIN EN 61010, part 2 – 020. Observe the notes for bio safety systems in chapters "Notes on safety" and "Maintenance and servicing".</p> |
|--|--|











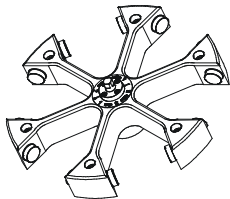





4176		4522-A							
<b>Ausschwingrotor 6-fach / Swing out rotor 6-times</b>    $\angle 90^\circ$									
		4213		4213-93			4214		
									
		0501	0578						
Kapazität / capacity	ml	6	7	4,5 - 5	5	2,7 - 3	15	7,5 - 8,5	8,5 - 10
Maße / dimensions $\varnothing \times L$	mm	12 x 82	12 x 100	11 x 92	12 x 75	11 x 66	17 x 100	15 x 92	16 x 100
Anzahl p. Rotor / number p. rotor		288	288	288	288	288	180	180	180
Drehzahl / speed	RPM	4500							
RZB / RCF	<sup>2)</sup>	5818							
Radius / radius	mm	257							
 9 (97%)	sec	125							
 9	sec	197							
Temperatur / temperature	$^\circ\text{C}$ <sup>1)</sup>	14							

4176		4522-A							
<b>Ausschwingrotor 6-fach / Swing out rotor 6-times</b>    $\angle 90^\circ$									
		4214		4214-93		4215	4216	4218	
									
			0518				---	0521	0523
Kapazität / capacity	ml	10	15	4,5 - 5	4 - 7	25	30	50	100
Maße / dimensions $\varnothing \times L$	mm	15 x 102	17 x 100	15 x 75	16 x 75	24 x 100	25 x 110	34 x 100	44 x 115
Anzahl p. Rotor / number p. rotor		180	180	180	180	66	66	36	24
Drehzahl / speed	RPM	4500							
RZB / RCF	<sup>2)</sup>	5818							
Radius / radius	mm	257							
 9 (97%)	sec	125							
 9	sec	197							
Temperatur / temperature	$^\circ\text{C}$ <sup>1)</sup>	14							

1) Tiefste erreichbare Temperatur bei maximaler Drehzahl, 1 h Laufzeit und 20°C Raumtemperatur  
 2) Zentrifugiergefäße aus Glas nur belastbar bis RZB 4000

1) Lowest possible temperature during maximum speed, 1 h running time and 20°C ambient temperature  
 2) Centrifuge containers of glass will not stand RCF values exceeding 4000



4176		4522-A						
<b>Ausschwingrotor 6-fach / Swing out rotor 6-times</b>    90°								
		4220		4222		4222-93		
								
								
Kapazität / capacity	ml	9 - 10	12	7	4 - 7	5	2,6 - 3,4	
Maße / dimensions Ø x L	mm	16 x 92	17 x 100	12 x 100	13 x 100	12 x 75	13 x 65	
Anzahl p. Rotor / number p. rotor		96	96	180	180	180	180	
Drehzahl / speed	RPM	4500						
RZB / RCF		5818						
Radius / radius	mm	257						
 9 (97%)	sec	125						
 9	sec	197						
Temperatur / temperature	°C <sup>1)</sup>	14						

4176		4522-A								
<b>Ausschwingrotor 6-fach / Swing out rotor 6-times</b>    90°										
		4222-93		4223		4223-93		4224	4225	
										
										
Kapazität / capacity	ml	1,6 - 5	9	8	12	4 - 7	4	1,5	2	
Maße / dimensions Ø x L	mm	13 x 75	14 x 100	16 x 125	16 x 101	16 x 75	10 x 88	11 x 38	11 x 38	
Anzahl p. Rotor / number p. rotor		180	150	150	150	150	378	504	504	
Drehzahl / speed	RPM	4500								
RZB / RCF		5818								
Radius / radius	mm	257								
 9 (97%)	sec	125								
 9	sec	197								
Temperatur / temperature	°C <sup>1)</sup>	14								

1) Tiefste erreichbare Temperatur bei maximaler Drehzahl, 1 h Laufzeit und 20°C Raumtemperatur  
 2) Zentrifugiergefäße aus Glas nur belastbar bis RZB 4000

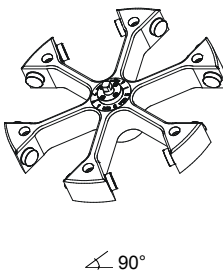
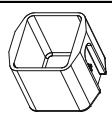
1) Lowest possible temperature during maximum speed, 1 h running time and 20°C ambient temperature  
 2) Centrifuge containers of glass will not stand RCF values exceeding 4000

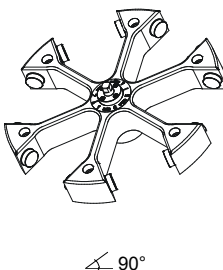
4176		4522-A							
<b>Ausschwingrotor 6-fach / Swing out rotor 6-times</b> 									
		4226	4232	4233		4238		4241	4245
		Microtainer	0509	4234	0551	5127	---	0513	
Kapazität / capacity	ml	0,8	15	750	600	250	290	25	50
Maße / dimensions Ø x L	mm	8 x 45	17 x 120	93 x 137	93 x 134	62 x 122	62 x 137	25 x 90	29 x 115
Anzahl p. Rotor / number p. rotor		468	138	6	6	6	6	48	48
Drehzahl / speed	RPM	4500	4500	4500	4500	4500	4500	4500	4500
RZB / RCF	<sup>2)</sup>	5818	5999	5999	5999	5818	5818	5818	5999
Radius / radius	mm	257	265	265	265	257	257	257	265
	9 (97%)					125			
	9					197			
Temperatur / temperature	°C <sup>1)</sup>					14			

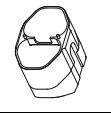









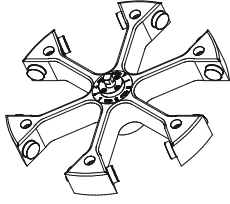













4176		4522-A					4524-A		
<b>Ausschwingrotor 6-fach / Swing out rotor 6-times</b> 									
		4249	4258	4258 + 4449		6322	SK 09.00	4529-O <sup>10)</sup>	4529-M <sup>10)</sup>
			0512	Corning	Corning				
Kapazität / capacity	ml	50	750	500	250	14	500		
Maße / dimensions Ø x L	mm	29 x 115	97 x 152	96 x 147	60 x 162	16,5 x 106	---		
Anzahl p. Rotor / number p. rotor		36	6	6	6	138	12		
Drehzahl / speed	RPM	4500	4500	4500	4500	4500	4500		
RZB / RCF	<sup>2)</sup>	5909	5999	5999	5818	5954	6498		
Radius / radius	mm	261	265	265	257	263	287		
	9 (97%)					125			
	9					197			
Temperatur / temperature	°C <sup>1)</sup>			14				16	











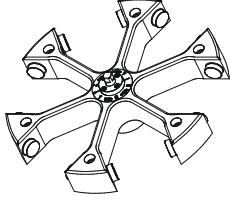

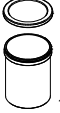

- 1) Tiefste erreichbare Temperatur bei maximaler Drehzahl, 1 h Laufzeit und 20°C Raumtemperatur
- 2) Zentrifugiergefäße aus Glas nur belastbar bis RZB 4000
- 3) Gefäß nur belastbar bis RZB 700
- 8) Bei Temperaturen über 40 °C und/oder geringer Befüllung der Gefäße können sich diese verformen.
- 10) Darf nur in Gehänge 4524-A und beidseitig beladen verwendet werden. Bei Verwendung der Haltestifte darf die max. RZB 1000 nicht überschritten werden.

	Position der Haltestifte	Abstand der Haltestifte vom Einsatzboden (innen)
4529-O	oben	199,5 mm
4529-M	Mitte	182,0 mm
4529-U	unten	164,5 mm

- 1) Lowest possible temperature during maximum speed, 1 h running time and 20°C ambient temperature
- 2) Centrifuge containers of glass will not stand RCF values exceeding 4000
- 3) tube will not stand RCF values exceeding 700
- 8) At temperatures above 40 °C and/or poor filling of the tubes, these can go out of shape.
- 10) May only be used in bucket 4524-A and with both sides loaded. If the holding pins are used the max. RCF of 1000 may not be exceeded.

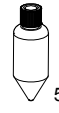
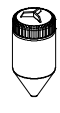









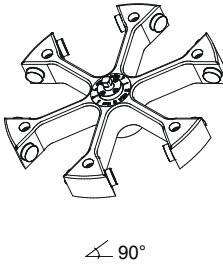
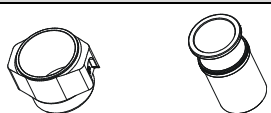



	Position of the holding pins	Distance of the holding pins from the bottom of the inserts (inside)
4529-O	upper section	199.5 mm
4529-M	middle section	182.0 mm
4529-U	lower section	164.5 mm









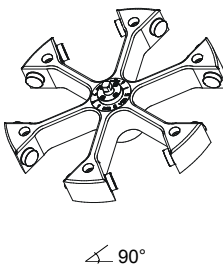

4176	4524-A			4546-A	4591-A	4595-A		
<b>Ausschwingrotor 6-fach / Swing out rotor 6-times</b>    								
	Baxter/ 4525	Biopack/ 4525	Fenwal 4525 6)	4592-A	4559-H/ 4559-N	4592-A	4596	
								
	2 x 4526	2 x 4527	2 x 4528	4-fach/ 4-times	1-fach/ 1-times	4-fach/4-times	4-fach/ 4-times	0550 8)
								
Kapazität / capacity ml	500	500	500	500   750	450	500   450	2000	100
Maße / dimensions Ø x L mm	----	----	----	----	----	----	180x150x100	----
Anzahl p. Rotor / number p. rotor	12	12	12	12	12	12	6	12
Drehzahl / speed RPM	4500	4500	4500	4500	4500	4500	3500	1000
RZB / RCF	6498	6498	6498	6498	6271	6498	3848	312
Radius / radius mm	287	287	287	287	277	287	281	279
 9 (97%) sec							125	
 9 sec							197	
Temperatur / temperature °C <sup>1)</sup>							16	
							-10	

4176	4579-A	4579-A + 4255 / 4255-P 4)						
<b>Ausschwingrotor 6-fach / Swing out rotor 6-times</b>    								
				4449	4430			
								
		4255 / 4255-P 4)	0512	4239	Corning		Nalgene®	Nunc®
								
Kapazität / capacity ml	1000	750	1000	500	250	175	200	
Maße / dimensions Ø x L mm	98 x 138	97 x 152	98 x 175	96 x 147	60 x 162	61,5 x 144	60 x 130	
Anzahl p. Rotor / number p. rotor	6	6	6	6	6	6	6	
Drehzahl / speed RPM	4500							
RZB / RCF	6294							
Radius / radius mm	278							
 9 (97%) sec	125							
 9 sec	197							
Temperatur / temperature °C <sup>1)</sup>	4							

- 1) Tiefste erreichbare Temperatur bei maximaler Drehzahl, 1 h Laufzeit und 20°C Raumtemperatur (nur bei Kühlzentrifuge)
- 4) 4255-P: spezielle Oberflächenbehandlung für höchste hygienische Ansprüche
- 5) 4255 nicht mit Deckel verschließbar
- 6) Sowie Macopharma, Terumo, Kawasumi
- 8) Bei Temperaturen über 40 °C und/oder geringer Befüllung der Gefäße können sich diese verformen.
- 11) Maximale Beladung 800g. Bei einer Beladung über 800g muss die Drehzahl reduziert werden, siehe Beschriftung auf dem Becher. Berechnung der reduzierten Drehzahl siehe Kapitel "Zentrifugation von Stoffen oder Stoffgemischen mit einer höheren Dichte als 1,2 kg/dm<sup>3</sup>".

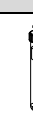







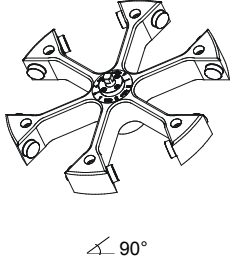

- 1) Lowest possible temperature during maximum speed, 1 h running time and 20°C ambient temperature (only with cooling centrifuges)
- 4) 4255-P: special surface treatment for highest hygienic requirements
- 5) 4255 cannot be closed with the lid
- 6) as soon as Macopharma, Terumo, Kawasumi
- 8) At temperatures above 40 °C and/or poor filling of the tubes, these can go out of shape.
- 11) Maximum load 800g. With a load higher than 800g the speed has to be reduced, see label on the bucket. Calculation of the reduced speed see chapter "Centrifugation of materials or mixtures of materials with a density higher than 1.2 kg/dm<sup>3</sup>".

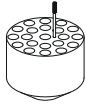
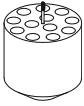
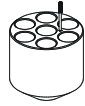
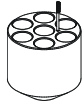



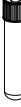
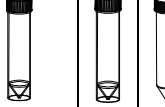





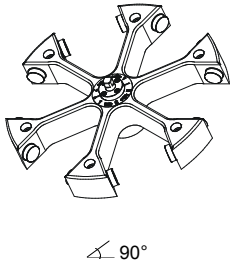

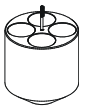

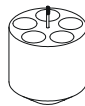
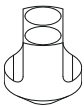
4176		4579-A + 4255 / 4255-P 4)								
<b>Ausschwingrotor 6-fach / Swing out rotor 6-times</b>  $\angle 90^\circ$										
		4432		4433				4434		
										
		2078	0536		0578			0500	2079	0518
										
Kapazität / capacity	ml	1,5	2,0	5	7	2,7 - 3	4,5 - 5	9	10	15
Maße / dimensions	Ø x L	mm	11 x 38	12 x 75	12 x 100	11 x 66	11 x 92	14 x 100	17 x 70	17 x 100
Anzahl p. Rotor / number p. rotor			252	180	180	180	180	114	114	114
Drehzahl / speed	RPM		4500	4500	4500	4500	4500	4500	4500	4500
RZB / RCF	<sup>2)</sup>		5796	5750	5750	5750	5750	5886	5886	5886
Radius / radius	mm		256	254	254	254	254	260	260	260
 9 (97%)	sec									125
 9	sec									197
Temperatur / temperature	°C <sup>1)</sup>									4

4176		4579-A + 4255 / 4255-P 4)								
<b>Ausschwingrotor 6-fach / Swing out rotor 6-times</b>  $\angle 90^\circ$										
		4434								
										
										
Kapazität / capacity	ml	10	10	8	4 - 5,5	9 - 10	4 - 7	8,5 - 10		
Maße / dimensions	Ø x L	mm	15 x 100	16 x 80	16 x 81	15 x 75	16 x 92	16 x 75	16 x 100	
Anzahl p. Rotor / number p. rotor		114	114	114	114	114	114	114		
Drehzahl / speed	RPM									4500
RZB / RCF	<sup>2)</sup>									5886
Radius / radius	mm									260
 9 (97%)	sec									125
 9	sec									197
Temperatur / temperature	°C <sup>1)</sup>									4

- 1) Tiefste erreichbare Temperatur bei maximaler Drehzahl, 1 h Laufzeit und 20°C Raumtemperatur (nur bei Kühlzentrifuge)
- 2) Zentrifugiergefäße aus Glas nur belastbar bis RZB 4000
- 4) 4255-P: spezielle Oberflächenbehandlung für höchste hygienische Ansprüche
- 5) 4255 nicht mit Deckel verschließbar

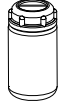

- 1) Lowest possible temperature during maximum speed, 1 h running time and 20°C ambient temperature (only with cooling centrifuges)
- 2) Centrifuge containers of glass will not stand RCF values exceeding 4000
- 4) 4255-P: special surface treatment for highest hygienic requirements
- 5) 4255 cannot be closed with the lid



4176		4579-A + 4255 / 4255-P 4)															
<b>Ausschwingrotor 6-fach / Swing out rotor 6-times</b>   ∠ 90°				4435		4437		4438		4438 + 0726							
																	
																	
		Kapazität / capacity ml		2,6 – 3,4		4,9		1,6 - 5		4 – 7		15		25		30	
Maße / dimensions Ø x L mm		13 x 65		13 x 90		13 x 75		13 x 100		17 x 120		25 x 90		25 x 110		24 x 100	
Anzahl p. Rotor / number p. rotor		126		126		126		126		72		42		42		42	
Drehzahl / speed RPM		4500		4500		4500		4500		4500		4500		4500		4500	
RZB / RCF 2)		5750		5750		5750		5750		6022		5818		5818		5615	
Radius / radius mm		254		254		254		254		266		257		257		248	
 9 (97%)		sec								125							
 9		sec								197							
Temperatur / temperature °C 1)										4							

4176		4579-A + 4255 / 4255-P 4)															
<b>Ausschwingrotor 6-fach / Swing out rotor 6-times</b>   ∠ 90°				4439		4440		4441		4442		4443					
																	
																	
		Kapazität / capacity ml		50		225		175		50		100		290		250	
Maße / dimensions Ø x L mm		34 x 100		61 x 137		61 x 118		29 x 115		44 x 100		62 x 137		61 x 122			
Anzahl p. Rotor / number p. rotor		24		6		6		30		12		6		6			
Drehzahl / speed RPM		4500		4500		4500		4500		4500		4500		4500			
RZB / RCF 2)		5705		6294		6294		5999		5683		6113		6113			
Radius / radius mm		252		278		278		265		251		270		270			
 9 (97%)		sec								125							
 9		sec								197							
Temperatur / temperature °C 1)										4							

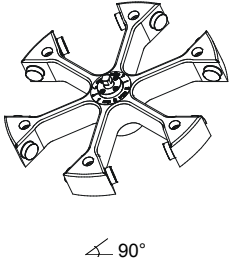
- 1) Tiefste erreichbare Temperatur bei maximaler Drehzahl, 1 h Laufzeit und 20°C Raumtemperatur (nur bei Kühlzentrifuge)
- 2) ZentrifugiergefäÙe aus Glas nur belastbar bis RZB 4000
- 3) GefäÙ nur belastbar bis RZB 700
- 4) 4255-P: spezielle Oberflächenbehandlung für höchste hygienische Ansprüche
- 5) 4255 nicht mit Deckel verschließbar
- 8) Bei Temperaturen über 40 °C und/oder geringer Befüllung der GefäÙe können sich diese verformen.

- 1) Lowest possible temperature during maximum speed, 1 h running time and 20°C ambient temperature (only with cooling centrifuges)
- 2) Centrifuge containers of glass will not stand RCF values exceeding 4000
- 3) tube will not stand RCF values exceeding 700
- 4) 4255-P: special surface treatment for highest hygienic requirements
- 5) 4255 cannot be closed with the lid
- 8) At temperatures above 40 °C and/or poor filling of the tubes, these can go out of shape.

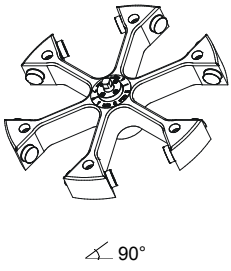





4176		4579-A + 4255 / 4255-P 4)						
<b>Ausschwingrotor 6-fach / Swing out rotor 6-times</b>  ↙ 90°								
		4466	SK 39.93	SK 61.98				
		0551	0530					
Kapazität / capacity ml		600	250	50				
Maße / dimensions Ø x L mm		93 x 134	65 x 115	29 x 115				
Anzahl p. Rotor / number p. rotor		6	6	30				
Drehzahl / speed RPM		4500	4500	4500				
RZB / RCF 2)		6294	5841	5796				
Radius / radius mm		278	258	256				
↘ 9 (97%) sec		125						
↘ 9 sec		197						
Temperatur / temperature °C 1)		4						



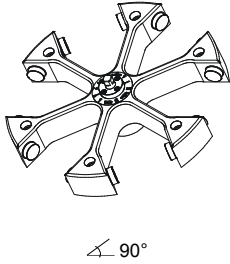
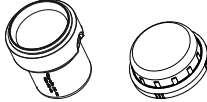



4176		4547-A + 5621							
<b>Ausschwingrotor 6-fach / Swing out rotor 6-times</b>  ↙ 90°									
				4449	4430		4432		
		0512	4239	Corning	Corning	Nalgene	Nunc	2078	0536
Kapazität / capacity ml		750	1000	500	250	175	200	1,5	2,0
Maße / dimensions Ø x L mm		97 x 152	96 x 176	96 x 147	60 x 162	61,5 x 144,3	60 x 130	11 x 38	11 x 38
Anzahl p. Rotor / number p. rotor		6	6	6	6	6	6	252	252
Drehzahl / speed RPM		4500	4500	4500	4500	4500	4500	4500	4500
RZB / RCF 2)		6384	6384	6384	6384	6384	6348	5886	5886
Radius / radius mm		282	282	282	282	282	282	260	260
↘ 9 (97%) sec		125							
↘ 9 sec		197							
Temperatur / temperature °C 1)		9							

- 1) Tiefste erreichbare Temperatur bei maximaler Drehzahl, 1 h Laufzeit und 20°C Raumtemperatur
- 2) Zentrifugiergefäße aus Glas nur belastbar bis RZB 4000
- 4) 4255-P: spezielle Oberflächenbehandlung für höchste hygienische Ansprüche
- 8) Bei Temperaturen über 40 °C und/oder geringer Befüllung der Gefäße können sich diese verformen.

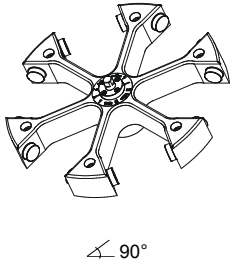
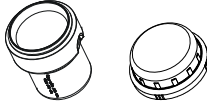
- 1) Lowest possible temperature during maximum speed, 1 h running time and 20°C ambient temperature
- 2) Centrifuge containers of glass will not stand RCF values exceeding 4000
- 4) 4255-P: special surface treatment for highest hygienic requirements
- 8) At temperatures above 40 °C and/or poor filling of the tubes, these can go out of shape.



4176		4547-A + 5621							
<b>Ausschwingrotor 6-fach / Swing out rotor 6-times</b>    90°									
		4433				4434			
									
Kapazität / capacity	ml	5	7	2,7 - 3	4,5 - 5	9	10	10	
Maße / dimensions	∅ x L	mm	12 x 75	12 x 100	11 x 66	11 x 92	14 x 100	17 x 70	16 x 80
Anzahl p. Rotor / number p. rotor			180	180	180	180	114	114	114
Drehzahl / speed	RPM		4500	4500	4500	4500	4500	4500	4500
RZB / RCF	<sup>2)</sup>		5841	5841	5841	5841	5977	5977	5977
Radius / radius	mm		258	258	258	258	264	264	264
 9 (97%)	sec	125							
 9	sec	197							
Temperatur / temperature	°C <sup>1)</sup>	9							







4176		4547-A + 5621							
<b>Ausschwingrotor 6-fach / Swing out rotor 6-times</b>    90°									
		4434							
									
Kapazität / capacity	ml	8	4 - 5,5	7,5 - 8,2	9 - 10	4 - 7	8	8,5 - 10	12
Maße / dimensions	∅ x L	mm	16 x 81	15 x 75	15 x 92	16 x 92	16 x 75	16 x 125	16 x 101
Anzahl p. Rotor / number p. rotor			114	114	114	114	114	114	114
Drehzahl / speed	RPM		4500	4500	4500	4500	4500	4500	4500
RZB / RCF	<sup>2)</sup>		5977	5977	5977	5977	5977	5977	5977
Radius / radius	mm		264	264	264	264	264	264	264
 9 (97%)	sec	125							
 9	sec	197							
Temperatur / temperature	°C <sup>1)</sup>	9							



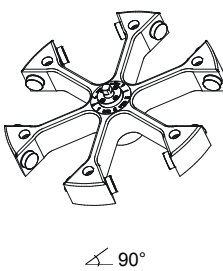
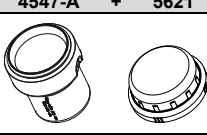

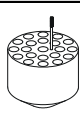
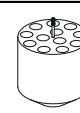
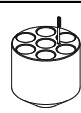
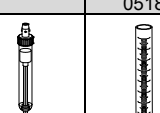
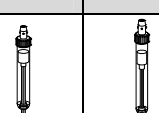
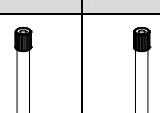
1) Tiefste erreichbare Temperatur bei maximaler Drehzahl, 1 h Laufzeit und 20°C Raumtemperatur

2) Zentrifugiergefäße aus Glas nur belastbar bis RZB 4000

1) Lowest possible temperature during maximum speed, 1 h running time and 20°C ambient temperature

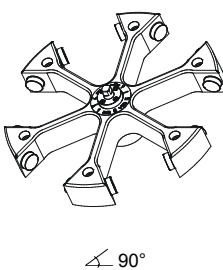
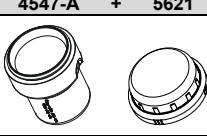
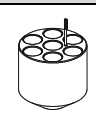
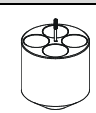
2) Centrifuge containers of glass will not stand RCF values exceeding 4000

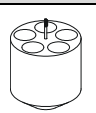
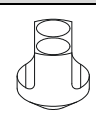
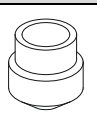
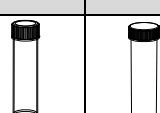
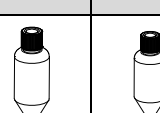
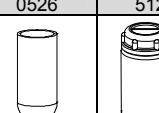
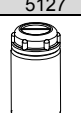
4176		4547-A + 5621							
<b>Ausschwingrotor 6-fach / Swing out rotor 6-times</b>  ∠ 90°									
		4434		4435				4437	4438 + 0726
									
		0518				0509		0519	
									
Kapazität / capacity	ml	10	15	2,6 – 3,4	4,9	1,6 – 5	4 – 7	15	25
Maße / dimensions	∅ x L	15 x 102	17 x 100	13 x 65	13 x 90	13 x 75	13 x 100	17 x 120	24 x 100
Anzahl p. Rotor / number p. rotor		114	114	126	126	126	126	72	42
Drehzahl / speed	RPM	4500	4500	4500	4500	4500	4500	4500	4500
RZB / RCF	<sup>2)</sup>	5977	5977	5841	5841	5841	5841	6090	5728
Radius / radius	mm	264	264	258	258	258	258	269	253
 9 (97%)	sec	125							
 9	sec	197							
Temperatur / temperature	°C <sup>1)</sup>	9							

4176		4547-A + 5621								
<b>Ausschwingrotor 6-fach / Swing out rotor 6-times</b>  ∠ 90°										
		4438		4439		4440		4441	4442	4443
										
				0521		0513		0526	5127	
										
Kapazität / capacity	ml	25	30	50	225	175	50	100	250	
Maße / dimensions	∅ x L	25 x 90	25 x 110	34 x 100	61 x 137	61 x 118	29 x 115	44 x 100	62 x 122	
Anzahl p. Rotor / number p. rotor		42	42	24	6	6	30	12	6	
Drehzahl / speed	RPM	4500	4500	4500	4500	4500	4500	4500	4500	
RZB / RCF	<sup>2)</sup>	5909	5909	5773	6384	6348	6090	5750	6203	
Radius / radius	mm	261	261	255	282	282	269	254	274	
 9 (97%)	sec	125								
 9	sec	197								
Temperatur / temperature	°C <sup>1)</sup>	9								

1) Tiefste erreichbare Temperatur bei maximaler Drehzahl, 1 h Laufzeit und 20°C Raumtemperatur









2) Zentrifugiergefäße aus Glas nur belastbar bis RZB 4000

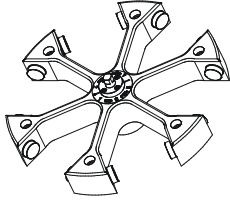

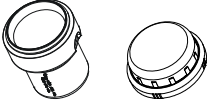

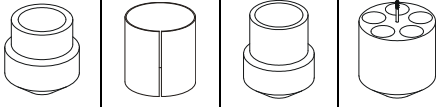
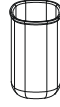
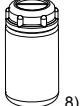

8) Bei Temperaturen über 40 °C und/oder geringer Befüllung der Gefäße können sich diese verformen.

1) Lowest possible temperature during maximum speed, 1 h running time and 20°C ambient temperature

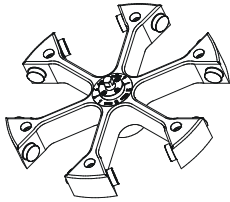
2) Centrifuge containers of glass will not stand RCF values exceeding 4000

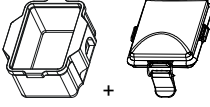
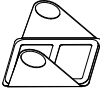





8) At temperatures above 40 °C and/or poor filling of the tubes, these can go out of shape.



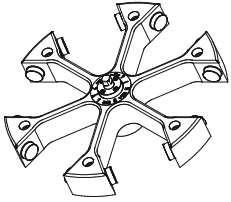

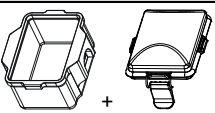
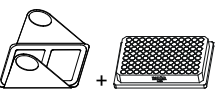



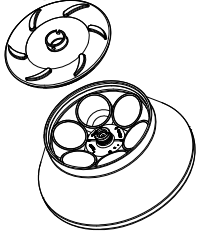

4176	4547-A + 5621				4523-A				
<b>Ausschwingrotor 6-fach / Swing out rotor 6-times</b>    									
	4443	4466	SK 39.93	SK 61.98	4516				
									
			0551	0530		4-fach / 4-times	1-fach / 1-times	1-fach / 1-times	
Kapazität / capacity	ml	290	600	250	50	500	750	1000	
Maße / dimensions	Ø x L	mm	62 x 137	93 x 134	65 x 115	29 x 115	---	---	---
Anzahl p. Rotor / number p. rotor		6	6	6	30	6	6	6	
Drehzahl / speed	RPM	4500	4500	4500	4500	4500	4500	4500	
RZB / RCF	<sup>2)</sup>	6203	6384	6158	5886	6452	6452	6520	
Radius / radius	mm	274	282	272	260	285	285	288	
 9 (97%)	sec	125							
 9	sec	197							
Temperatur / temperature	°C <sup>1)</sup>	9							

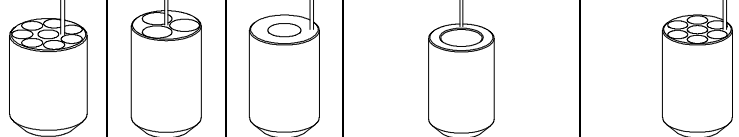
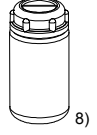
4176	SK 06.07 + 5629								
<b>Ausschwingrotor 6-fach / Swing out rotor 6-times</b>    									
	4626								
									
	MTP	MTP	MS	CP	DWP	Microtest- platten / plate Terasaki	QP		
									
Maße / dimensions	Ø x L	mm	86x128x15	86x128x17,5	86x128x46	86x128x22	86x128x44,5	59x84x11	86x128x 83
Anzahl p. Rotor / number p. rotor		36	30	6	24	6	12	6	6
Drehzahl / speed	RPM	4500	4500	4500	4500	4500	4500	4500	4500
RZB / RCF	<sup>2)</sup>	5139	5139	5139	5139	5139	5139	5139	5139
Radius / radius	mm	227	227	227	227	227	227	227	227
 9 (97%)	sec	125							
 9	sec	197							
Temperatur / temperature	°C <sup>1)</sup>	- 3							

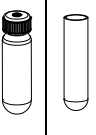
- |  |  |
|--|--|
| 1) Tiefste erreichbare Temperatur bei maximaler Drehzahl, 1 h Laufzeit und 20°C Raumtemperatur     | 1) Lowest possible temperature during maximum speed, 1 h running time and 20°C ambient temperature |
| 2) ZentrifugiergefäÙe aus Glas nur belastbar bis RZB 4000  | 2) Centrifuge containers of glass will not stand RCF values exceeding 4000                         |
| 8) Bei Temperaturen über 40 °C und/oder geringer Befüllung der GefäÙe können sich diese verformen. | 8) At temperatures above 40 °C and/or poor filling of the tubes, these can go out of shape.        |

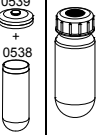
MTP Mikrotiterplatte / Microtitre plate	CP Kulturplatte / Culture plate	DWP Deep Well Platte / Deep well plate	MS Micronic System / Micronic system	QP Filterplatte / Filter plate
--	------------------------------------	---	---	-----------------------------------

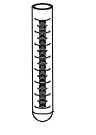
4176		SK 06.07 + 5629							
<b>Ausschwingrotor 6-fach / Swing out rotor 6-times</b>    									
		<b>4626 + 1485</b> 							
PCR-Platte 96-fach/ PCR-plate 96 times		PCR-Strips							
									
Kapazität / capacity	ml	---	0,2						
Maße / dimensions	Ø x L	mm	82x124x20	---					
Anzahl p. Rotor / number p. rotor			6	72					
Drehzahl / speed	RPM		4500	4500					
RZB / RCF	<sup>2)</sup>		5139	5139					
Radius / radius	mm		227	227					
 9 (97%)	sec	125							
 9	sec	197							
Temperatur / temperature	°C <sup>1)</sup>	- 3							

4570		---											
<b>Winkelrotor 6-fach / Angle rotor 6-times</b>     mit Bioabdichtung / with bio-containment <sup>9)</sup>													
		5127		---		0545 0519		0546		0539 + 0538		0547 0549	
													
Kapazität / capacity	ml	250	10	30	25	50	94	85	85	15	15		
Maße / dimensions	Ø x L	mm	61,5 x 122	16 x 80	26 x 95	24 x 100	29 x 107	38 x 106	38 x 106	38 x 102	17 x 100	17 x 100	
Anzahl p. Rotor / number p. rotor		6	48	18	6	6	6	42	42	42	42		
Drehzahl / speed	RPM	6000	6000	6000	6000	6000	6000	6000	6000	6000	6000	6000	
RZB / RCF	<sup>2)</sup>	5594	5353	5152	4830	4910	4910	4910	4910	5313	5313		
Radius / radius	mm	139	133	128	120	122	122	122	122	132	132		
 9 (97%)	sec	64											
 9	sec	69											
Temperatur / temperature	°C <sup>1)</sup>	- 16											

- 1) Tiefste erreichbare Temperatur bei maximaler Drehzahl, 1 h Laufzeit und 20°C Raumtemperatur
- 2) Zentrifugiergefäße aus Glas nur belastbar bis RZB 4000
- 8) Bei Temperaturen über 40 °C und/oder geringer Befüllung der Gefäße können sich diese verformen.
- 9) Nach DIN EN 61010, Teil 2 – 020. Die Hinweise für Bio-Sicherheitssysteme in den Kapiteln "Sicherheitshinweise" und "Pflege und Wartung" beachten.

- 1) Lowest possible temperature during maximum speed, 1 h running time and 20°C ambient temperature
- 2) Centrifuge containers of glass will not stand RCF values exceeding 4000
- 8) At temperatures above 40 °C and/or poor filling of the tubes, these can go out of shape.
- 9) In conformity with DIN EN 61010, part 2 – 020. Observe the notes for bio safety systems in chapters "Notes on safety" and "Maintenance and servicing".