

# Heraeus

## Labofuge 300

### Instructions for Use

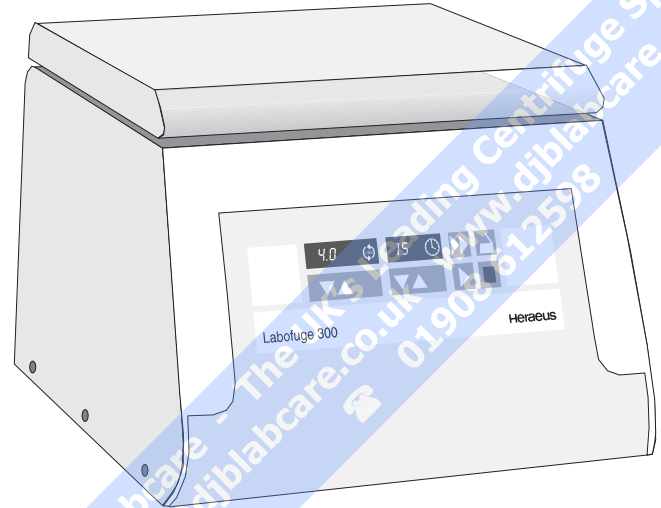

DJB Labcare - The UK's Leading Centrifuge Specialist  
info@djblabcare.co.uk www.djblabcare.co.uk  
01902 612598

## How to use this manual

Use this manual to get acquainted with your centrifuge and its accessories.

The manual helps you to avoid inappropriate handling. Make sure to keep it always close to the centrifuge.

**A manual that is not kept handy cannot provide protection against improper handling and thus against damage to persons and objects.**

The manual comprises chapters on

- Safety regulations
- Instrument description
- Rotor program and accessories
- Transportation and hook-up
- Operation of the centrifuge
- Maintenance and care
- Troubleshooting
- Technical data
- Index

Overleaf you will find a graphic representation of the control panel with a survey of the most important functions

# Please fold out

DJB Labcare - The UK's Leading Centrifuge Specialist  
info@djblabcare.co.uk www.djblabcare.co.uk  
01908 612598

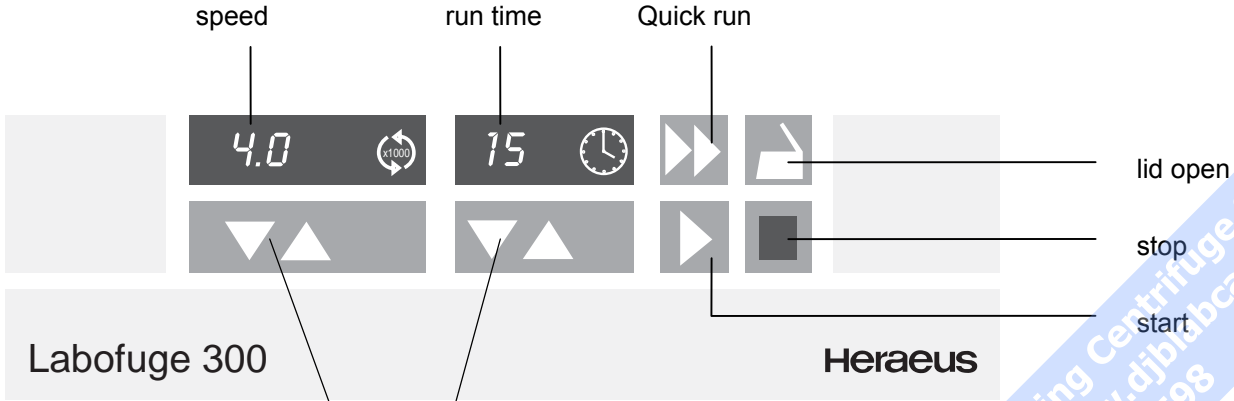

"set" keys



*back panel:*  
socket for mains cable  
mains switch

DJB Labcare - The UK's Leading Centrifuge Specialist  
 info@djblabcare.co.uk www.djblabcare.co.uk 01908 612598

# The control panel of the Labofuge 300

## Display

### Speed

Resting state: preselected speed  
During run: current speed; *rotating light*: rotor turns  
End: "End"  
Running/resting: error codes (if present)

### Time

Resting/end: preselected run time (in minutes; in "hold" mode, "hd")  
During run: remaining run time or (with quick start) run time passed  
Lid open: "OP"

### Keys

Start: normal start  
Stop: manual stop  
Open lid: open lid (possible only with mains switch ON)  
Quick run: short-term acceleration as long as key is pressed, with indication of run time passed  
"Set" keys: stepwise increase/decrease of preset values, accelerated change when pressed permanently

Short pressing of any of the "set" keys: switch from current to preset value

*Error codes (corrective measures see "Troubleshooting"):*

E-0: motor does not run (transport protection?)  
E-8: overvoltage  
E-10: internal error  
E-11: internal error  
br: instrument turned off during run or power failure  
Lid: lid popped open or opened during run; drive overtemperature  
OP: with lid closed: safety circuit has been triggered (drive overtemperature)

**Messages can span several display panels**

# Contents

**For your safety..... 3**  
 Proper use.....3  
 Improper use .....3  
 Centrifuging hazardous materials .....3  
 Handling .....4  
 Conformity to current standards.....5  
 Safety instructions in this manual .....5

**The Labofuge 300..... 7**  
 Safety systems .....7  
 Properties.....8  
 Functions and features.....9  
 The Easycontrol-user interface .....10  
 Items delivered.....11

**Accessories ..... 12**  
 Rotor program .....13  
 Adapters.....14

**Before use..... 16**  
 Transport and installation.....16  
 Proper location .....16  
 Mains connection .....16

**Operation.....17**  
 Switching on the centrifuge .....17  
 Opening the lid .....17  
 Inserting the rotor .....17  
 Loading the rotor .....19  
     Maximum loading .....19  
     Filling the centrifuge tubes .....19  
     Placing the tubes in the rotor.....20  
 Entering parameters.....22  
     Selecting the speed .....22  
     Selecting the run time.....22  
         Predetermined run time .....22  
         Continuous operation.....23  
 Starting the centrifuge .....23  
 Changing the settings during the run .....23  
 Stopping the centrifuge .....24  
     Stopping with preset time .....24  
     Stopping with continuous operation .....24  
 Short-time centrifugation .....24  
 Removing the rotor .....25  
 RCF value .....25

DJB Labcare - The UK's Leading Centrifuge Specialist  
 info@djblabcare.co.uk www.djblabcare.co.uk 01598 625598

**Maintenance and care ..... 27**  
Maintenance operations to be carried out by the customer.....27  
    Cleaning .....27  
    Disinfection .....28  
The Service of KENDRO.....30  
Warranty conditions .....30

**Troubleshooting ..... 31**  
Emergency lid release.....31  
Problems you can handle yourself.....33  
In case you must call the Service .....37  
Technical Data .....38  
Electrical connections .....39

**Index ..... 41**

**Appendix: speed/RCF diagrams ..... 46**

DJB Labcare - The UK's Leading Centrifuge Specialist  
info@djblabcare.co.uk www.djblabcare.co.uk  
01908 612598

## For your safety

Heraeus centrifuges are manufactured according to current technical standards and regulations. Nonetheless, centrifuges may pose dangers if

- they are not used as designed
- they are operated by untrained personnel
- their design is improperly changed
- the safety instructions are not heeded

**Therefore anybody concerned with operation and maintenance of the centrifuge must read and follow the safety instructions.**

In addition, the pertinent regulations for prevention of accidents must be strictly followed.



This manual is an integral part of the centrifuge assembly and must be kept close at hand at all times.

## Proper use

The centrifuge is designed to separate liquid-suspended materials having different densities and particle size, respectively. The maximum sample density is  $1.2 \text{ g/cm}^3$  at maximum speed.

## Improper use

During a run, a safety zone of 30 cm around the centrifuge must be maintained where neither persons nor hazardous materials may be stationed.

The centrifuge may cause harm to you or other persons and may damage material goods if you do not follow the following safety measures:

## Centrifuging hazardous materials

- The centrifuge is neither made inert, nor is it explosion-proof. Therefore never use the centrifuge in an explosion-prone environment.
- Explosive or flammable substances must not be centrifuged. The same holds for substances prone to react briskly with each other.

DJB Labcare - Centrifuge Specialist  
info@djblabcare.co.uk  
01208 511198

## For your safety

---

- Do not centrifuge toxic or radioactive substances or pathogenic microorganisms unless you have taken proper precautions.  
Such precautions can e.g. consist of biological seals.
- Should toxins or pathogenic substances enter the centrifuge or its parts, you must carry out the proper procedures for disinfection (see "Maintenance and care – Disinfection").
- Strongly corrosive substances that may cause damage to materials and impair the mechanical strength of the rotor may be centrifuged only inside protective vessels.
- Changes in mechanical or electrical components may be carried out only by persons authorized to this effect by Kendro Laboratory Products.
- You may use the centrifuge only with a properly loaded rotor. You must not overload the rotor.
- If the rotor or the lid shows visible traces of corrosion or wear, you must stop using it.
- Strictly follow the rules and regulations for cleaning and disinfection.

## Handling

- Never use the centrifuge unless the rotor is properly mounted.
- Never manually open the lid if the rotor still turns.
- Use only original parts for the centrifuge. The only exception are common glass or plastic centrifuge tubes if these are approved for the rotor speed and RCF values of your rotor, respectively.
- Never use the centrifuge with the lid open.
- Never use the centrifuge if the paneling has been partially or totally removed.



## Conformity to current standards

Heraeus centrifuges are manufactured and tested according to the following standards and regulations: for all voltages:



- IEC 1010-1 / EN 61010-1
- IEC 1010-2 / EN 61010-2-020
  - Pollution degree 2
  - Overvoltage category II

for 120 V only:

- CAN/CSA-C22.2 No. 1010.1-92
- CAN/CSA-C22.2 No. 1010.2.020-94

## Safety instructions in this manual



This symbol denotes potential hazards to persons.



This symbol denotes potential damage to the centrifuge or parts in its immediate surroundings.



General hints are marked with this symbol.

In addition, you are asked to adhere to the pertinent regulations, in Germany

- Regulations for prevention of accidents VBG 4
- Regulations for prevention of accidents VBG 5
- Regulations for prevention of accidents VBG 7z

For your safety

---

for your notes

DJB Labcare - The UK's Leading Centrifuge Specialist  
info@djblabcare.co.uk www.djblabcare.co.uk  
01908 612598

## The Labofuge 300

The figure below shows a general view of the *Labofuge 300* with open lid and the rotor put into place.

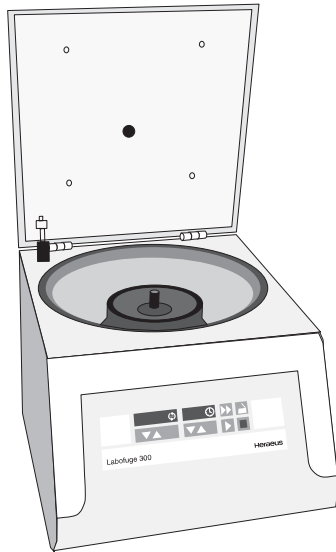

### Safety systems

The Labofuge 300 is equipped with a number of safety systems:

- Housing and rotor chamber manufactured from impact-resistant plastic; inner armoring made of steel
- Lid with window and lid lock  
You can open the centrifuge lid only when the power is turned on and the rotor has come to a halt. You can start the centrifuge only if the lid is properly locked.
- Warning if instrument is manually opened during a run  
If the lid is manually opened during a run, or if the temperature of the drive exceeds a critical value, a corresponding message appears in the display ("Lid" and "OPEN", respectively).
- Emergency lid release: only in case of emergency, e.g. during power failure (see chapter "Troubleshooting")



**Do not tamper with the safety systems!**

## Properties

The Labofuge 300 is a laboratory centrifuge that is delivered with an 8-place swinging bucket rotor including 8 suspensions each for 7 ml and 15 ml respectively. With this combination, commercially available blood sampling and glass tubes can be centrifuged.





The user-friendly "Easycontrol" control panel permits easy preselection of speed and run time.

You can change the set values even during a run.

The maintenance-free induction motor provides quiet and vibration-free operation even at high speeds and warrants an extremely long lifetime.

DJB Labcare - The UK's Leading Centrifuge Specialist  
info@djblabcare.co.uk www.djblabcare.co.uk  
01908 612598

## Functions and features

Part / function	Description / feature
design / housing	galvanized sheet chassis with armored shell and plastic housing placed on top
tank	plastic
drive	induction drive without carbon brushes
key and display board	key and display elements covered by an easy-care protective foil
control	microprocessor-driven by Easycontrol II
program memory	the data last entered remain in memory
Lid lock	automatic locking upon pressing the lid shut
lid opening	electromagnetic release via "open lid" key  when mains supply OK (unlocking in case of power failure: see chapter "Troubleshooting")
start	start key (  )
stop	stop key (  )
short-term acceleration	"quick run" key (  ): short-term run when permanently pressed; stop upon key release

## The Easycontrol-user interface

Function	Feature
parameter memory	<ul style="list-style-type: none"> <li>• speed</li> <li>• run time</li> </ul>
speed selection	adjustable in steps of $100 \text{ min}^{-1}$ in the range $300 \text{ min}^{-1}$ to $4000 \text{ min}^{-1}$
run time selection	adjustable in minutes from 1 min to 99 min; "hd"-mode: permanent operation
run time display in "quick run" mode	between 1 s and 60 s in seconds steps, above in minutes
end of run	speed display reads "End"
diagnostic messages	<ul style="list-style-type: none"> <li>• incorrectly closed lid: display "OP"</li> <li>• general malfunction (error messages ERROR codes, see chapter "Troubleshooting")</li> </ul>

## Items delivered

Items delivered with the centrifuge comprise:

- 1 swinging bucket rotor 76003265  
8 suspensions 15 ml  
8 suspensions 7 ml
- a special cap nut for fixing the rotor
- 10- mm tubular socket wrench for fastening the cap nut
- power cord

The printed documents consist of the delivery notes and this Manual.



**High-performance plastic rotors have a limited lifetime. For reasons of safety they must be replaced after 5 years of use!**

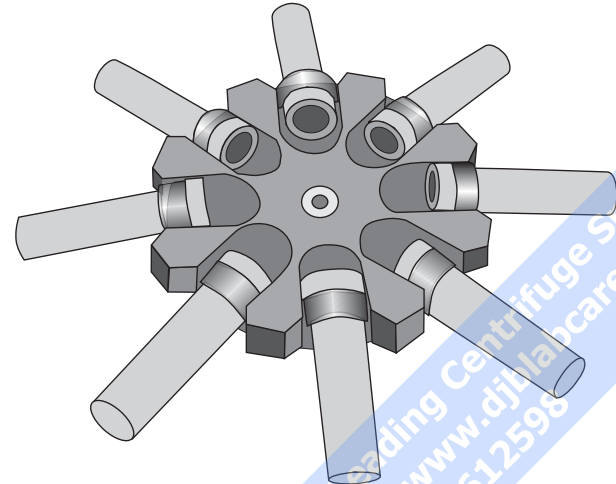

cap nut  
order no.  
70056208

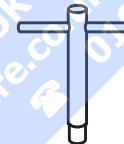

tubular socket  
wrench  
order no..  
20360072

## Accessories

As an accessory, you can optionally order the fixed-angle rotor 75003760 in addition to the swinging bucket rotor.

(See rotor program, Table 1.)

Please consult Table 2 for a detailed list of accessories including technical data, order numbers and applications.



**The fixed-angle rotor 75003760 may only be fastened with the wing nut supplied with the rotor!**

**For safe use consult the notes in the leaflet delivered with the rotor.**

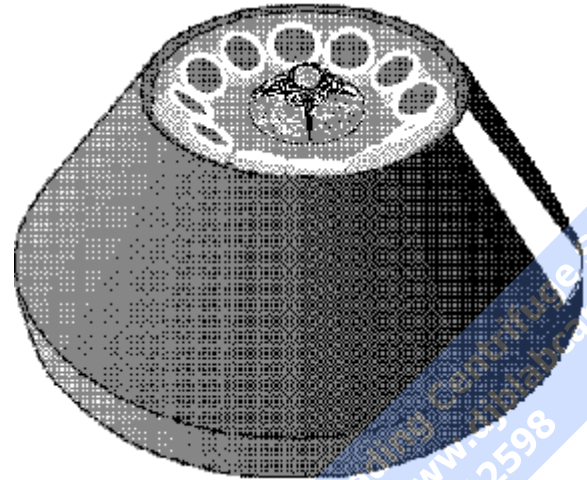



## Rotor program

*Table 1: rotor program (1)*

Rotor designation	<b>swinging bucket rotor</b> <b>8 x 15 / 7 ml</b>	<b>fixed angle rotor</b> <b>12 x 15 ml</b>	
order no.	<b>7600 3265</b>	<b>7500 3760</b>	
maximum permissible load [ g ]	8 x 18 / 8.5	12 x 18	
maximum speed $n_{\max}$ [ $\text{min}^{-1}$ ]	3,600	4,000	
maximum RCF value at $n_{\max}$	2,028	1,717	
maximum radius [ cm ]	14	9.6	
minimum radius [ cm ]	5.7	4.0	
angle [ ° ]	90	35	
acceleration time [ s ]	28	29	
braking time [ s ]	29	32	
maximum sample temperature after 30 min permanent operation	room temperature + 15 K	room temperature + 15 K	
autoclavable	no	no	

## Adapters

<i>Table 2: accessories and suitable vessels</i>					
for swinging bucket rotor 7600 3265	suitable vessel dimensions [ mm ]		number per rotor	color	order no:
	diameter	length			
suspension 15 ml	- 16.5	- 113	8	rot	7600 3262 (set of 8)
buffering spacer for short vessels		- 90	8		7600 3266
suspension 7 ml	- 13	- 113	8	yellow	7600 3263 (set of 8)
buffering spacer for short vessels		- 90	8		7600 3266
The rotor is suitable for all blood sampling vessels corresponding to the vessel dimensions stated (e.g.. Vacutainer®, Monovetten®, Primavetten®, Venoject ).					

\* delivered as standard equipment !

*Table 2: accessories and suitable vessels*

for fixed-angle rotor 7500 3760	suitable vessel dimensions [ mm ]		number per rotor	color	order no.
	diameter	length			
	16	100	12		
rubber pads	12	85			7500 3762
protective casing for glasses	16	100	12		7500 3763
adapters set 7 ml DIN and 5/7 ml blood consisting of:					7500 3227
adapters 7 ml DIN	12	100	12	yellow	7600 3225 *
adapters 5/7 ml blood	13	100	12 / 6 <sup>1)</sup>	white	7600 3226 *
spacers	13	75	12 / 6 <sup>1)</sup>		7600 3266 *
spacers	13	65	12 / 6 <sup>1)</sup>		7600 3266 *

<sup>1)</sup> number of the vessels for using is independent form the form of the cap

\* replacement number.; deliverable by the service

## Before use

### Transport and installation



#### **Damage to the centrifuge by jolting!**

**Transport the centrifuge only in the upright position using the special box provided with the instrument and secure it properly. Place the centrifuge carefully.**

### Proper location

The location for the centrifuge must meet the following criteria:

- A safety zone of at least 30 cm around the centrifuge must be maintained where no hazardous materials may be stationed during centrifugation.
- The substructure must be stable and resonance-free. A good support is provided by a plane laboratory bench or a large laboratory carriage with lockable casters.
- To ensure sufficient air circulation, a minimum distance from the wall of 10 cm at the back and of 15 cm on each side must be kept.

- The centrifuge must be protected from heat and direct sunshine.

### Mains connection

Make sure that voltage and frequency correspond to the specifications on the instrument label.

Turn the mains switch on the back panel off (press "0"); only then connect the centrifuge with the mains supply via the power cord.

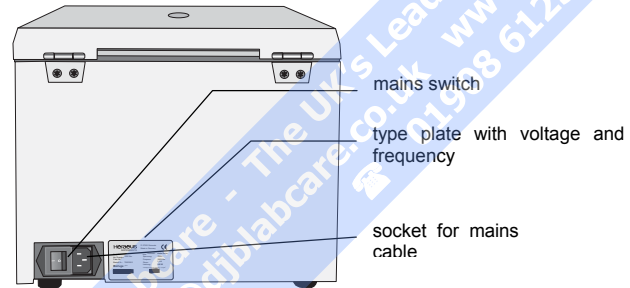

## Operation

### Switching on the centrifuge

Turn on the mains switch at the back of the instrument.



For a couple of seconds the following reading appears in the control panel:

This tells you that the instrument carries out an internal check of its software. (see table on page 37).

After this check the display changes. The values now shown in the display panel are the ones last used.

The following figure gives an example of possible readings. A detailed description of possible settings is given later on in this chapter.



In this example, the preset speed is 3500 rpm and the preset run time is 10 min.

### Opening the lid

Push the "open lid" key .

(Emergency lid release in case of malfunction or power failure: see section "Troubleshooting".)

### Inserting the rotor



**Improper or improperly combined accessories may cause severe damage to the centrifuge!**

The rotors approved for the Labofuge 300 are detailed in the chapter "Accessories". Use only rotors with this instrument that are contained in this list.

To insert the rotor, you need the rotor, the cap nut and the tubular socket wrench supplied (see chapter "Accessories – items delivered").



**Possible damage to drive and rotor!**

**You may insert the rotor only if the temperature of the drive, the rotor and the cap nut is between 10 °C and 30 °C.**

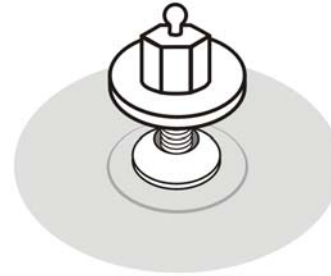

Proceed as follows:

1. Open the lid and make sure that the rotor chamber and the rotor are clean. Remove eventual dust, foreign material or sample residues. The thread and the O-Ring on the motor shaft must be in perfect condition.
2. Turn the rotor so that the notch for engaging the drive shaft points downward.
3. Place the rotor on top of the drive shaft so that the notch of the rotor is located precisely above the retaining pin.
4. Push the rotor gently down until the retaining pin is engaged and thread is completely laid bare (see figure).

5. If you have placed the rotor correctly, you can screw on the cap nut easily and secure it with the tubular socket wrench delivered with the instrument.



**Do not push the rotor down using force. If you cannot screw on the cap nut, you must carefully lift off the rotor and insert it again.**



Regularly check the proper positioning of the rotor and re-tighten the cap nut as needed.

## Loading the rotor

### Maximum loading



**Overloading may cause the rotor to explode! Exploding parts may severely damage the centrifuge!**

The Labofuge 300 can reach high rotational speeds implying enormous centrifugal force. The rotors are designed in a way warranting high residual strength even at the highest permissible speed.

However, this safety system presupposes that the maximum permissible load of the rotor is not exceeded.

If you wish to centrifuge samples that together with the adapters exceed the maximum permissible load, you must either reduce the sample volume or calculate the permissible speed  $n_{perm}$  according to the following formula:

$$n_{perm} = n_{max} * \sqrt{\frac{\text{maximum permissible load}}{\text{actual load}}}$$

## Filling the centrifuge tubes



**Check carefully whether your sample vessels are permissible for the respective  $g$  value and reduce the speed if necessary.**

The smaller the unbalance of the centrifuge, the better the separation since separated zones are no longer perturbed by vibration. It is therefore important to balance the centrifuge tubes as well as possible.

To minimize unbalance you should fill the tubes as evenly as possible. You can achieve this by eye. However, you must nonetheless ensure that opposite tubes are filled to the same level.

### Placing the tubes in the rotor

The swinging bucket rotor must always be loaded completely and symmetrically! It is essential that you supply unused places with water-filled tubes.

If you wish to partially load a fixed-angle rotor, you must ensure that opposite bores always receive tubes of equal weight (when centrifuging a single sample, place a centrifuge tube e.g. filled with water opposite).

properly loaded rotors

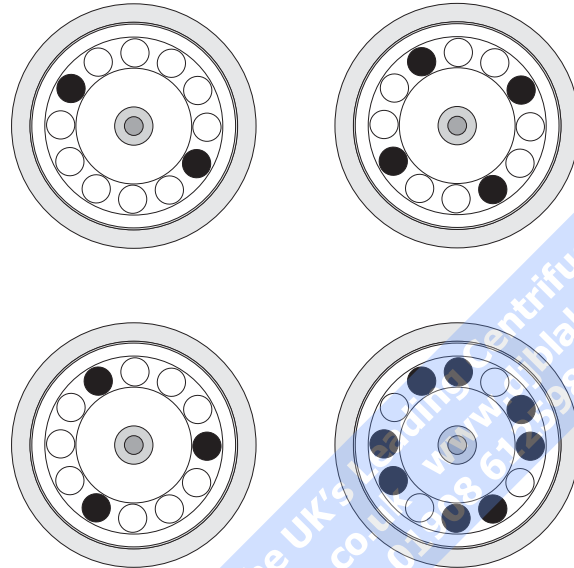





**Uneven loading of the rotor can in the extreme case cause damage to rotor and centrifuge. Unbalance not only causes a noisy run, but also rapidly damages the motor suspension.**

After placing the tubes, close the centrifuge lid by firmly pressing it down. The lid must snap audibly into place so that it cannot be opened manually any more.

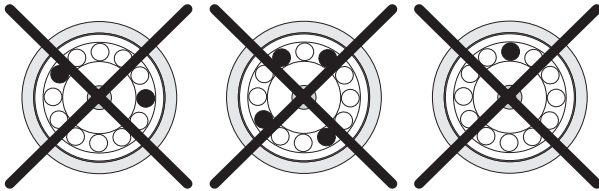

Improperly loaded rotors

These examples are to be applied to the other rotors in an analogous manner!

## Entering parameters

### Selecting the speed

The centrifuge can be set to a minimum of 300 min<sup>-1</sup> and to a maximum of 4.000 min<sup>-1</sup>. The built-in micro-processor prevents higher or lower speed settings. Between these extremes, you can select the speed in steps of 100 rpm using the following procedure:

1. Press one of the "set" keys  (for an increase) or  (for a decrease) in the "speed" section of the control panel (see also the foldout page in the cover).



By pressing the selected key **briefly**, you increase or decrease the speed in steps of 100 rpm. This option is supposed to be used for small changes and fine tuning.

2. If you keep the key pressed, the display changes at first slowly and after a few seconds at an accelerated pace.
3. Release the key as soon as you have reached the desired value, and fine tune if necessary by repeatedly pressing the selected key. The digit after the decimal point flashes for a number of seconds,



then changes to permanent display. The speed is now stored.

### Selecting the run time

You can select a run time between 1 and 99 min or continuous operation.

#### *Predetermined run time*

To predetermine the run time, proceed as follows:

1. Press one of the "set" keys  (for an increase) or  (for a decrease) in the "time" section of the control panel (see also the foldout page in the cover):



By pressing the selected key **briefly**, you increase or decrease the preset run time in steps of 1 min. This option is supposed to be used for small changes and fine tuning.

2. If you keep the key pressed, the display changes at first slowly and after a few seconds at an accelerated pace.
3. Release the key as soon as you have reached the desired value, and fine tune if necessary by repeatedly pressing one of the keys. The minute display flashes for a number of seconds, then

changes to permanent. The run time is now stored.

### **Continuous operation**

To operate the Labofuge 300 in the continuous mode, you must press the key  until the display changes to "hd" (for "hold").

With this setting, the centrifuge keeps running until stopped manually.

Please note that the lifetime of plastic tubes in particular is limited. Extended use may damage them!

### **Starting the centrifuge**

Once the rotor is in place, the mains switch turned on and the lid closed, you can start the centrifuge.

Press the "start" key  in the control panel. The centrifuge accelerates to the preselected value. Simultaneously, the run time display starts going backward from the preset time, giving the remaining run time in minutes. After reaching the last minute, the display switches to seconds remaining (with continuous operation, the time display goes forward). The rotating light in the "speed" panel signals that the centrifuge is running. During the run you cannot open the lid.

### **Changing the settings during the run**

You can change the settings during a run. The respective altered setting flashes for a couple of seconds. Once the display changes to the continuous mode, the new settings become operative.

DJB Labcare - The UK's Leading Centrifuge Specialist  
info@djblabcare.co.uk www.djblabcare.co.uk  
01908 612598



## Stopping the centrifuge

### Stopping with preset time

Normally the run time has been preselected, and all you have to do is wait until the centrifuge terminates the run automatically. As soon as the speed is down to zero, the display reads "End". By pressing the "open lid" key , you can now open the lid and remove your samples.

You can stop the centrifuge at any time by pressing the "stop" key .

### Stopping with continuous operation

If you have chosen continuous operation, you must stop the centrifuge manually. Press the "stop" key  in the control panel. The centrifuge starts braking at once and stops within a few seconds. The display reads "End", the electrical lid unlocking mechanism is available. You can now open the lid by pressing the "open lid" key  and remove your samples.

## Short-time centrifugation

For short-term operation, the Labofuge 300 is equipped with a "quick run" function.

Short-term centrifugation is started by pressing the "quick run" key  continuously; it stops as soon as the key is released.

In this mode the centrifuge accelerates with full power up to the maximum speed of the respective rotor unless you stop the run by releasing the "quick run" key . The preset speed is ignored.



**Depending on the rotor inserted, the centrifuge accelerates to the maximum permissible speed!**

**Check carefully whether you have to maintain a specific speed for your application.**

During acceleration the time is counted forward in seconds. After 60 seconds the display changes to the minute mode.

## Removing the rotor

To remove the rotor, you must follow the steps described for insertion in reverse order.



**Danger of irreparable motor damage!**

**Never tilt the rotor when lifting it off.  
Always pull the rotor out perpendicularly.**

1. Open the centrifuge lid.
2. Loosen the cap nut by turning the supplied socket wrench counterclockwise and remove it.
3. Grab the rotor with both hands and lift it off carefully from the drive shaft. Make sure not to tilt it.

## RCF value

The **relative centrifugal force** (RCF) is given in multiples of the earth gravity  $g$ . It is a dimensionless number that allows one to compare the efficiency of separation or sedimentation of diverse instruments, since it is independent of the instrument used. The only values entered in the equation are radius and speed of centrifugation:

$$RCF = 11.18 * \left( \frac{n}{1000} \right)^2 * r$$

$r$  = radius of centrifugation in cm

$n$  = speed in rpm

The maximum RCF value refers to the maximum radius of the vessel bore.



Please note that this value becomes lower depending on the tubes and adapters used.

You may take this into account when calculating the RCF value for your application.

Operation

---

for your notes

DJB Labcare - The UK's Leading Centrifuge Specialist  
info@djblabcare.co.uk www.djblabcare.co.uk  
01908 612598

## Maintenance and care

### Maintenance operations to be carried out by the customer

For the protection of persons, the environment and the equipment you are obliged to clean the centrifuge regularly and to disinfect it if necessary.



**Unsuitable cleaning agents or disinfection procedures may damage the centrifuge and its parts!**

**For cleaning and disinfection use only the cleaning and disinfection procedures detailed in this manual.**

### Cleaning



**Pull mains plug before cleaning the instrument!**

The main care is to clean regularly (or as need arises) the housing, the rotor chamber, the rotor and the accessories. This is indicated both for reasons of hygiene and to prevent corrosion due to contamination sticking to the instrument and its accessories.

For cleaning you should use only agents approved by KENDRO:

- Caraform
- deconex 16 NT
- Extran MA 02 neutral
- RBS neutral

For all other cleaning agents please consult our Service Department!



**Organic solvents decompose the lubricant of the motor bearing. The drive shaft may jam.**

**Liquids and especially organic solvents must not come into contact with the drive shaft and the ball bearing during cleaning.**

## Disinfection



**Infectious material enters the centrifuge if spills or tube breakage occur!  
Danger of infection upon contact!**

**Comply with the permissible filling volume!**

**In case of contamination immediately disinfect rotor, rotor chamber and any accessories (adapters) involved.  
Wear protective gloves!**

If a centrifuge tube containing infectious material becomes leaky or breaks during a run, you must immediately disinfect the centrifuge. In doing this, you must heed the following points:

- To decontaminate the affected rotor chamber and rotor, use only disinfectants approved by KENDRO. These agents are to be used according to the Instructions for use supplied with the respective disinfectant:
  - Aldasan 2000
  - Carlitt Spray
  - Coldspore

- Gigasept FF
- HBV Pump-Spray
- Incidin Liquid Spray
- Incidur Spray
- Incidin plus
- Kohrsolin iD
- Lysetol FF
- Lysoform
- Lysoformin 3000
- Sagromed
- Sagrotan

For all other disinfectants please consult our Service Department!

- You may disinfect the rotor and the accessories as described in the following section. Be sure to follow the pertinent safety procedures for handling infectious material.
  1. Pull the mains plug.
  2. Unscrew the cap nut.
  3. Grab the rotor with both hands and pull it perpendicularly off the drive shaft.
  4. Remove the centrifuge tubes and adapters, and disinfect them or dispose of them as necessary.



5. Treat the rotor and the rotor lid according to the instructions given for the disinfectant in question (soaking in liquid or spraying). You must strictly observe the specified reaction times!
6. Turn the rotor head down and drain it. Thoroughly rinse rotor and lid with distilled water.
7. Dispose of the disinfectant solution as required by current regulations concerning chemicals.
8. Aluminum rotors must subsequently be treated with anticorrosive grease.



**Disinfection with eau de Javelle or by autoclaving is not permitted!**

DJB Labcare - The UK's Leading Centrifuge Specialist  
info@djblabcare.co.uk www.djblabcare.co.uk  
01908 612598

## The Service of KENDRO

Kendro Laboratory Products GmbH recommends annual servicing of the centrifuge and the accessories by the authorized service or skilled personnel. The service provided by Heraeus comprises checking:

- the electrical installation
- the suitability of the location
- the lid lock mechanism and the safety circuit
- the rotor
- the rotor fastening and the drive shaft

Defective parts are exchanged. Besides, the service personnel cleans the rotor chamber.

KENDRO offers inspection and service contracts covering these benefits. Inspection costs are charged as flat-rate contracts.

Necessary repairs are carried out free of cost during the warranty period, and against payment after expiration of the warranty.

## Warranty conditions

The warranty period starts with the day of delivery. Within the warranty period the centrifuge is repaired or replaced free of cost if there are demonstrable faults in materials or workmanship.

Conditions for a warranty are that:

- the centrifuge is used according to the instructions of use
- installation, additions, adjustments, changes or repairs are carried out exclusively by personnel authorized for this by KENDRO
- the required maintenance and care procedures are carried out regularly.

## Troubleshooting

### Emergency lid release

In case of a power failure you cannot open the lid normally using the normal electrical lid unlocking mechanism. To permit unloading even in this case, the centrifuge is equipped with a manual lid unlocking system. However, you may use this system **only** in case of emergency.



**Rotor can spin at high speed! Touching it may cause severe injuries!**

**Always wait for several minutes until the rotor has come to a complete stop. Without power the brake does not function, and braking takes much longer than normal!**

In case you must manually open the centrifuge, you can achieve this using a special tool. Proceed as follows:

1. Make sure the rotor stands still (consult window in the lid).
2. Unplug the mains plug.

3. Push a thin wire of about 7 cm length (e.g. a bent-open paper clip) through the boring in the panel situated on the right between lid handle and the top of the housing. Push the locking mechanism back until the lid is unlocked. Remove the auxiliary tool and open the lid.

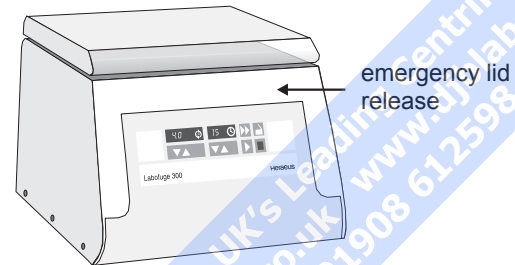

## Troubleshooting

---

4. If the rotor still turns, close lid immediately and wait until it has come to a complete stop.



**Never brake the rotor using your hands or tools!**

5. As soon as the rotor stands still, remove your samples and close the lid.

## Problems you can handle yourself



If problems other than those described in the following tables arise, you must consult the authorized service.

Error	Behavior of the centrifuge	Possible cause(s) and measures to be taken
Displays remain dark	<p>The motor stops.</p> <p>The rotor stops without braking.</p> <p>The lid cannot be opened..</p>	<p><b>Mains failure or not connected</b></p> <ol style="list-style-type: none"> <li>1. Is the mains switch turned on?</li> <li>2. Check the mains connection.</li> <li>3. If the mains connection is OK, call the nearest Service.</li> </ol>
Displays fail briefly.	<p>The motor stops suddenly.</p> <p>The rotor stops without braking.</p> <p>The display reads "br", see br.</p>	<p><b>Brief interruption of mains supply</b></p> <ol style="list-style-type: none"> <li>1. Check whether the mains plug is properly inserted into the mains socket</li> <li>2. Wait for 75 seconds.</li> <li>3. Restart the centrifuge.</li> </ol>

DJB Labcare - The UK's Leading Centrifuge Specialist  
 info@djblabcare.co.uk www.djblabcare.co.uk  
 01908 612598

## Troubleshooting

Error	Behavior of the centrifuge	Possible cause(s) and measures to be taken
Lid cannot be opened.	Pressing the "open lid" key has no effect.	<p><b>A) Lid not correctly engaged or lid warped.</b></p> <ol style="list-style-type: none"> <li>1. Check whether mains connection is OK and the instrument switched on (displays lit).</li> <li>2. Press lid down in the middle of the front section once, and actuate the "open lid" key anew.</li> <li>3. If this is unsuccessful, you may open the lid using the emergency lid release (see page 31).</li> </ol> <p><b>B) Heat monitoring relay of the lid unlocking mechanism has been actuated</b></p> <p>Press key again after a short pause (approx. 1 min).</p>
-	Centrifuge is exceptionally noisy.	<ol style="list-style-type: none"> <li>1. Stop the centrifuge by pressing the "stop" key , in case of emergency pull mains plug.</li> <li>2. Wait until the centrifuge stands still.</li> <li>3. Check whether the rotor is properly loaded.</li> <li>4. Check whether a broken vessel, damage to the rotor or motor malfunction was responsible for the noise.</li> </ol> <p>If you cannot locate and solve the problem, call Service.</p>
br	Instrument coasts to standstill	<p>There has been a short-term power failure, or the instrument has been turned off during a run.</p> <p>Wait for about 75 seconds; the instrument is then again ready for use.</p>

Error	Behavior of the centrifuge	Possible cause(s) and measures to be taken
E-0	Motor does not start.	<p><b>Motor or rotor blocked.</b></p> <ol style="list-style-type: none"> <li>1. Switch instrument off and on again using the mains switch.</li> <li>2. Open the lid.</li> <li>3. Check whether the rotor can turn freely.</li> </ol> <p>If you cannot thus relieve the malfunction, call our Service.</p>
E-8	Overvoltage at the U/F converter	Mains voltage outside tolerance. Brake resistance defective. Call Service if necessary.
E-10	Check sum in NV-RAM faulty	Switch the instrument off and on again. If the error persists, call our Service.
E-11	Error in data transmission from NV-RAM	Switch the instrument off and on again. If the error persists, call our Service.

DJB Labcare - The UK's Leading Centrifuge Specialist  
 info@djblabcare.co.uk www.djblabcare.co.uk  
 01908 612378

## Troubleshooting

Error	Behavior of the centrifuge	Possible cause(s) and measures to be taken
<p>Message "Lid" appears in display</p>	<p>Drive stops. Rotor stops without braking</p>	<p><b>A) Lid was opened manually during the run.</b></p> <ol style="list-style-type: none"> <li>1. Press the lid shut again. The instrument stops without braking.</li> <li>2. If you want to continue the run, you must switch the instrument off and on again. Subsequently the message "br" appears, and the instrument brakes (see br).</li> </ol> <p><b>B) Overtemperature protection of the motor has been triggered.</b></p> <ol style="list-style-type: none"> <li>1. Pull mains plug.</li> <li>2. Check and clean if necessary the ventilation slots underneath the instrument.</li> <li>3. You may restart the instrument after 20 min.</li> </ol> <p>If the safety circuit is triggered again, you must call our Service.</p>
<p>Display "OPEN" appears although lid is closed .</p>	<p>Start impossible.</p>	<p><b>A) Lid not properly closed</b></p> <p>Press the front of the lid firmly down.</p> <p><b>B) Overtemperature protection of the motor has been triggered.</b></p> <ol style="list-style-type: none"> <li>1. Pull mains plug.</li> <li>2. Check and clean if necessary the ventilation slots underneath the instrument.</li> <li>3. You may restart the instrument after approx. 20 min.</li> </ol> <p>If the safety circuit is triggered again, you must call our Service.</p>



## In case you must call the Service

Should you require our Service, please tell us the order no. and serial number of your instrument. You find the pertinent information at the back of the instrument near the socket for the mains plug.

Moreover it is helpful for our service technician to know the software version. You can determine the software version as follows:

1. Switch the instrument off.
2. Switch the instrument on.

All displays read 888 88 for about 2 seconds.

Subsequently, the display may show e.g. the following readings for 2 seconds each:

Software number	047	8_
Software version	_01	
NV-RAM number	104	1_
NV-RAM version	_01	

The values given are only examples! In the present example they mean:

- Software 0478 version 01
- NV-Ram 1041 version 01

DJB Labcare - The UK's Leading Centrifuge Specialist  
 info@djblabcare.co.uk www.djblabcare.co.uk  
 01908 612598

## Technical Data

Feature	Value
environmental conditions	<ul style="list-style-type: none"> <li>- indoor use</li> <li>- max. elevation 2000 m above sea level</li> <li>- max. relative humidity 80 % up to 31 °C; linearly decreasing down to 50 % relative humidity at 40 °C.</li> </ul>
permissible temperature of the environment	+2 °C to +40 °C
run time	1 min to 99 min, hLd (hold) = permanent operation
maximum speed $n_{\max}$	4,000 $\text{min}^{-1}$ (depending on rotor, adjustable in steps of 100)
minimum speed $n_{\min}$	300 $\text{min}^{-1}$
maximum RCF value at $n_{\max}$	2,028 (depending on rotor)
maximum kinetic energy	<10 kNm
noise at maximum speed	< 60 dB (A)
maximum sample temperature after 30 min permanent operation	room temperature + 15 K
dimensions (H x W x D)	315 mm x 380 mm x 475 mm
weight without rotor	30 kg

## Technical data

Feature	Value
standards	manufactured and tested in accordance with EN 61 010-1, EN 61 010-2-020, EN 50 081-1, EN 50 082-1;

## Electrical connections

order no.	voltage	frequency	nominal current	power consumption	fuses inside instrument
7500 3230	230 V	50/60 Hz	1.25 A	180 W	2 x 2 AT (5 x 20 mm)
7500 3231	120 V	50/60 Hz	2.2 A	180 W	2 x 4 AT (6.3 x 32 mm)
7500 3232	100 V	50/60 Hz	2.2 A	180 W	2 x 4 AT (6.3 x 32 mm)

DJB Labcare - The UK's Leading Centrifuge Specialist  
info@djblabcare.co.uk www.djblabcare.co.uk  
01908 612598

## Index

### A

- accessories
  - cap nut 11
  - cleaning 27
  - tubular socket wrench 11
- adapter
  - swinging bucket rotor 14
- adapters
  - fixed-angle rotor 15
- aluminium rotors
  - anticorrosive grease 29
- anticorrosive grease
  - for aluminium rotors 29
- approved rotors 17

### C

- cap nut
  - for fixed-angle rotor 12
  - for fixing rotor 11
  - regular re-tightening 18
  - re-tightening 18
- centrifuge exceptionally noisy 34
- centrifuge tubes
  - filling 19
- changing settings
  - during run 23

- cleaning 27
- cleaning agents 27
- conditions of warranty 30
- contamination
  - necessary measures 28
- continuous operation 24
- control panel
  - readings 8
- corrosive substances
  - protective vessels for 4

### D

- damage
  - symbol for potential 5
- danger
  - symbol 5
- dangerous chemicals 3
- decontamination 28
- disinfectants
  - approved 28
- disinfection 4, 28
  - eau de Javelle not permitted 29
  - procedure 28
- display
  - during run 23
- displays
  - brief failure 33
  - not lit 33
- distance
  - minimum from wall 16

## Index

---

### E

- Easycontrol
  - user interface 8
- Easycontrol user interface 10
- EC Guidelines 5
- electrical connections 39
- emergency lid release 7, 31
- environment
  - permissible temperature 38
- error messages
  - „br“ 34
  - „E-0“ 35
  - „E-10“ 35
  - „E-11“ 35
  - „E-8“ 35
  - „Lid“ 36
  - „OP“ bei geschlossenem Deckel 36

### F

- features 9
- fine tuning
  - run time 22
  - speed setting 22
- fixed-angle rotor 13
  - adapters 15
  - optional accessory 12
  - partial loading 20
  - special cap nut 12
- formula

42

- maximum permissible load 19
- frequency 16
- fuses 39

### H

- hazardous substances 3
- hazards
  - symbols used for 5
- hints
  - symbol for 5

### I

- icons
  - for denoting dangers and potential damage 5
- infectious material
  - precautions in case of tube breakage 28
- installation 16

### K

- Kendro Laboratory Products
  - Service 30

### L

- lid
  - blockage 34
  - opening 17

lid cannot be opened 34  
lid open during run  
  warning 7  
lid release  
  emergency 7  
lid unlocking mechanism  
  manual 31  
lifetime  
  of plastic rotor 11  
  plastic tubes 23  
lights  
  rotating 23  
loading  
  rotor 20  
location 16

## M

mains connection 16  
mains switch 17  
maintenance 27  
manual lid release 31  
manual lid unlocking 31  
manual stop 24  
maximum permissible load  
  formula for 19  
maximum sample density 3  
mechanical lid release 31

## O

opening  
  manually 31  
operation  
  continuous 24  
  short-time 24  
Operation 17  
organic solvents  
  not allowed for cleaning 27  
original parts  
  mandatory use 4  
overloading  
  dangers implied 19

## P

parameters  
  input 22  
pathogenic microorganisms  
  protection against 4  
permissible speed 19  
plastic rotors  
  limited lifetime 11  
plastic tubes  
  lifetime 23  
problems  
  handling of 33  
protective vessels  
  for corrosive substances 4

## Q

quick run function 24

## R

radius of centrifugation

for calculation of RCF value 25

RCF value 13, 25

readings

of control panel during run 8

relative centrifugal force 25

rotating lights 23

rotor

cap nut for fixing 11

cleaning 27

loading 20

putting into place 18

removal 25

rotor chamber

cleaning 27

rotor insertion

temperature 18

tools for 17

rotor program 13

rotors

approved 17

run time

fine tuning 22

range 22

setting 22

## S

safety distance

for centrifuge 16

safety instructions 3, 4

safety measures 3

safety standards 5

safety systems

built-in 7

safety zone 3, 16

sample density

maximum 3

service contracts 30

setting

run time 22

speed 22

settings

change during run 23

short-time operation 24

socket wrench 11

software check

internal 17

software version

determination 37

speed

fine tuning 22

permissible 19

speed of centrifugation

for calculation of RCF value 25

speed selection 22

standards



conformity to 5  
starting the centrifuge 23  
start-up 16  
suspensions  
  as standard equipment 11  
swinging bucket  
  as standard equipment 11  
swinging bucket rotor 13  
  adapter 14  
  loading 20  
symbols  
  for hazards and dangers 5

## T

technical data 38  
temperature of the environment  
  permissible range 38  
tools for inserting rotor 17  
toxins  
  protection against 4  
transport  
  precautions for 16  
tube  
  breakage with infectious material 28  
tubes  
  filling 19

## U

unbalance 19

user interface 10

## V

vessel dimensions  
  fixed-angle rotor 15  
  swinging bucket rotor 14  
voltage 16

## W

warning  
  lid open during run 7  
warranty conditions 30

DJB Labcare - The UK's Leading Centrifuge Specialist  
info@djblabcare.co.uk www.djblabcare.co.uk  
01908 612598

## Appendix: speed/RCF diagrams

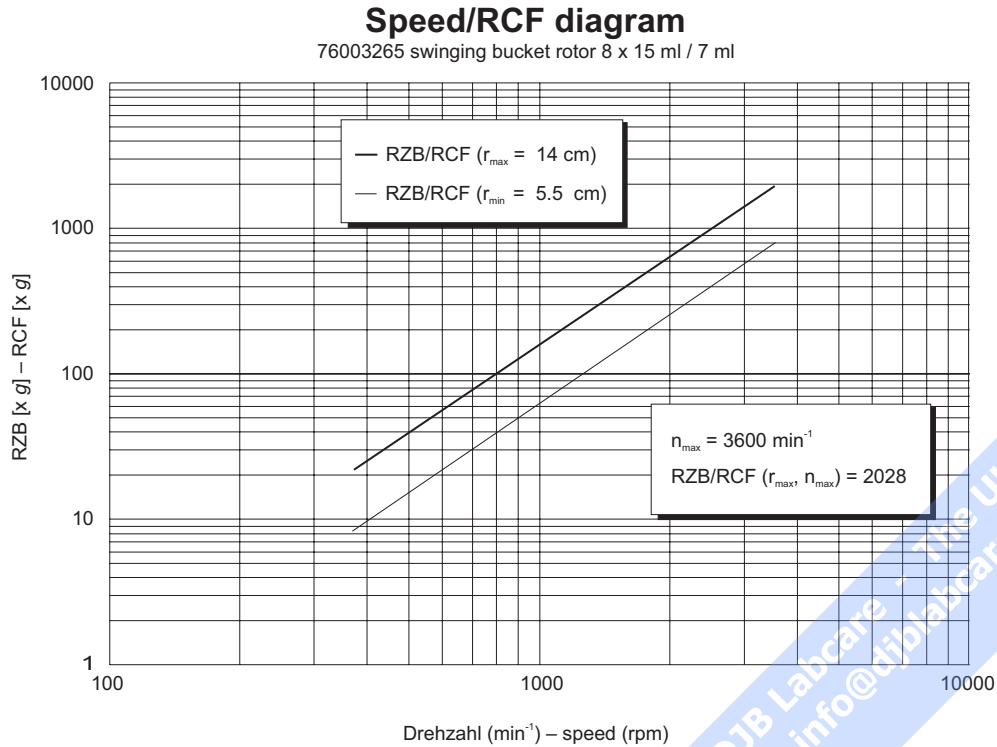

## Speed/RCF diagram

75003760 fixed-angle rotor 12 x 15 ml

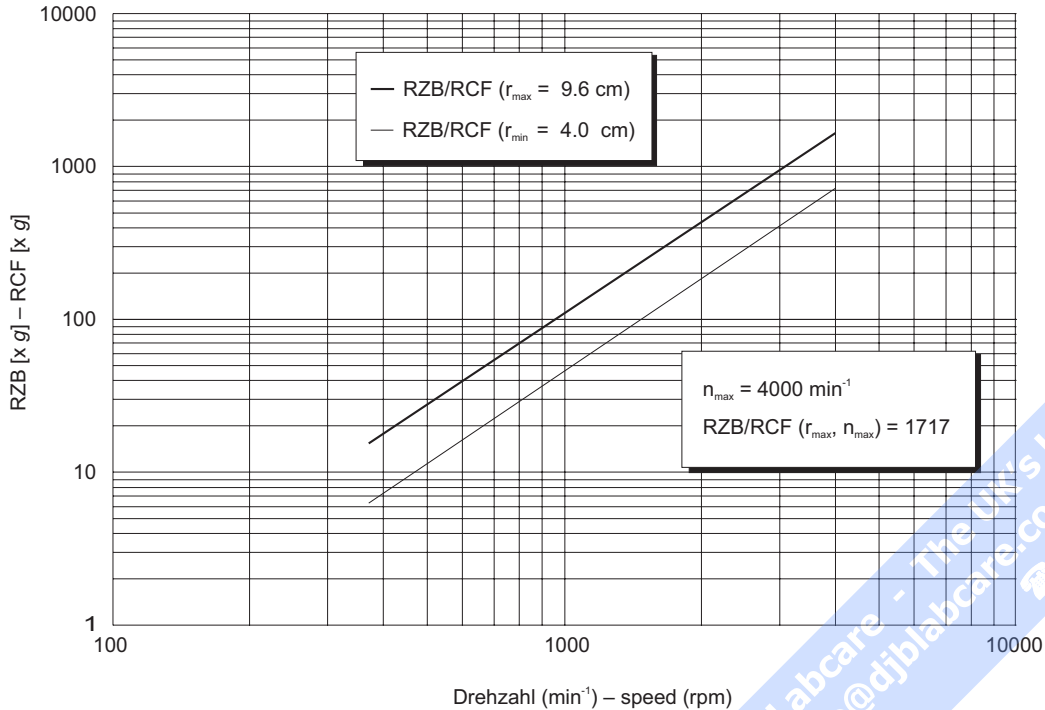

DJB Labcare - The UK's Leading Centrifuge Specialist  
info@djblabcare.co.uk www.djblabcare.co.uk  
01908 612598

**Australia** Kendro Laboratory Products Pty Ltd · Lane Cove, Sydney · NSW 2066 · Tel. +61 (0) 2 -9936 1540 · Fax +61 (0) 2 -9427 9765 · info@kendro.com.au  
**Austria** Kendro Laboratory Products GmbH · Vienna · Tel. +43 (0) 1-801 40 0 · Fax +43 (0) 1- 801 40 40 · office@kendro.at  
**Canada** Kendro Laboratory Products International Sales · Newtown, CT · USA · Tel. +1 203 -270 2080 · Fax +1 203-270 2166 · info@kendro.com  
**China** Kendro Laboratory Products Beijing Rep. Office · Beijing · Tel. +86 (0) 10-6501 3810 · Fax +86 (0) 10-6501 4229 · kendrobj@163bj.com  
 Kendro Laboratory Products (H.K.) Limited · Hong Kong · Tel. +852 2711 3910 · Fax +852 2711 3858 · info@kendro.com  
 Kendro Laboratory Products Shanghai Rep. Office · Shanghai · Tel. +86 (0) 21-5490 0216 · Fax +86 (0) 21-5490 0230 · kendrosh@public4.sta.net.cn  
**Denmark** Axeb AB · Albertslund · Tel. +45 (0) 43-6246 47 · Fax +45 (0) 43-6246 41 · info@axeb.dk  
**France** Kendro Laboratory Products SAS · Courtaboeuf cedex · Tel. +33 (0) 1-69 18 77 77 · Fax +33 (0) 1-60 92 00 34 · info@kendro.fr  
**Germany** Kendro Laboratory Products GmbH · Hanau · Tel +49 (0) 1805-536 376 · Fax +49 (0) 1805-112 114 · info@kendro.de  
**India** Kendro Laboratory Products (India) Pvt. Ltd. · New Delhi · Tel. +91 (0) 11-618 48 40 · Fax +91 (0) 11-618 53 97 · kendro.india@vsnl.com  
**Italy** AHSI S.p.A. · Cornate D'Adda · Tel. +39 039-68 271 · Fax +39 039-68 27 500 · info@ahsi.it  
**Japan** Nippon Kendro Co. Ltd. · Tokyo · Tel. +81 (0) 3 -3517 1661 · Fax +81 (0) 3-3517 1664 · info@kendro.co.jp  
**New Zealand** Kendro Laboratory Products Pty Ltd · Auckland · Tel. +64 (0) 9 -525 03 33 · Fax +64 (0) 9-525 03 37 · info@kendro.co.nz  
**Poland** Kendro Spółka z.o.o. · Warsaw · Tel. +48 (0) 22 -663 43 23 · Fax +48 (0) 22-663 43 25 · kendro.warszawa@kendro.com.pl  
**Portugal** Heraeus S.A. · Massamá · Tel. +351 (0) 214-387 630 · Fax +351 (0) 214-387 636 · heraeus@mail.telepac.pt  
**Spain** Heraeus S.A. · Madrid · Tel. +34 (0) 91-358 19 96 · Fax +34 (0) 91-358 20 67 · laboratorio@heraeus.es  
**Sweden** Axeb AB · Sollentuna · Tel. +46 (0) 8 -585 777 50 · Fax +46 (0) 8-623 15 45 · info@axeb.se  
**Switzerland** Kendro Laboratory Products AG · Zurich · Tel. +41 (0) 1-454 12 12 · Fax +41 (0) 1-454 12 99 · kendro-ag@swissonline.ch  
 Kendro Laboratory Products SA · Carouge (Geneva) · Tel. +41 (0) 22 -343 21 67 · Fax +41 (0) 22-342 38 31 · kendro-sa@swissonline.ch  
**U.K./Ireland** Kendro Laboratory Products PLC · Bishop's Stortford · Herts · Tel. +44 (0) 1279-827 700 · Fax +44 (0) 1279-827 750 · kendro@kendro.co.uk  
**USA** Kendro Laboratory Products · Newtown, CT · Tel. +1 800 -522 7746 · Fax +1 203-270 2166 · info@kendro.com

**All other countries in**  
**Asia Pacific** Kendro Laboratory Products (H.K.) Limited · Hong Kong · Tel. +852 2711 3910 · Fax +852 2711 3858 · info@kendro.com  
**Europe, Middle East, Africa** Kendro Laboratory Products International Sales · Hanau · Germany · Tel. +49 (0) 1805-536 376 · Fax +49 (0) 1805-112 114 · info@kendro.de  
**Latin America** Kendro Laboratory Products International Sales · Newtown, CT · USA · Tel. +1 203 -270 2080 · Fax +1 203-270 2210 · info@kendro.com

**Internet** <http://www.kendro.com>



Kendro Laboratory Products GmbH  
 Postfach 15 63  
 D-63405 Hanau  
 Telefon: (+49) 1805 / 536 376

In the interest of continuous product development, we reserve the right to make changes without express notice.

20056887 Labo 300\_uk 01/03  
 Printed in Germany

DJB Labcare - The UK's Leading Centrifuge Specialist  
 info@djblabcare.co.uk www.djblabcare.co.uk 01908 612598