

ROTOFIX 32 A



Ⓝ DE	Bedienungsanleitung	5
Ⓝ EN	Operating Instructions	20
Ⓝ FR	Mode d'emploi	35
Ⓝ IT	Istruzioni per l'uso	50

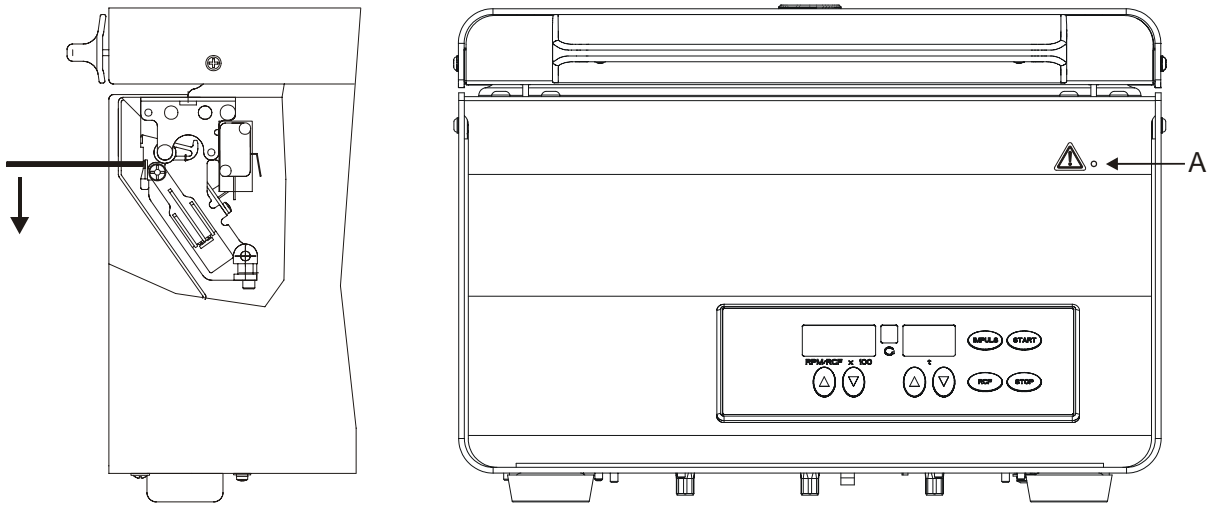

Fig. 1

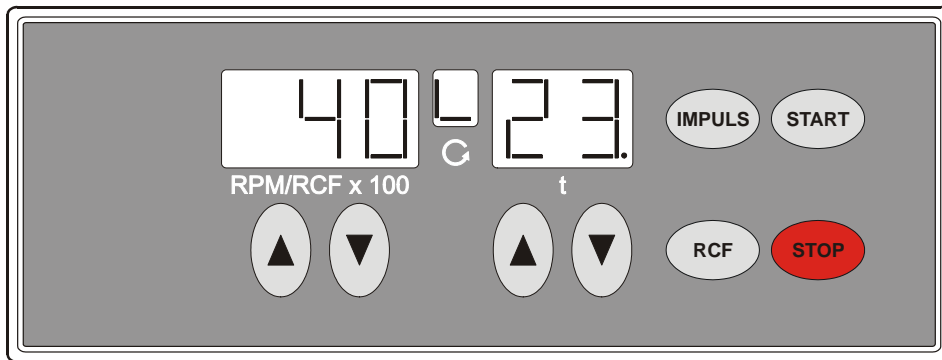

Fig. 2 ROTOFIX 32 A



**EG-Konformitätserklärung
EC Conformity Declaration
Déclaration de conformité CE
Dichiarazione di conformità alle norme CEE**

Andreas Hettich GmbH & Co. KG • Föhrenstraße 12 • D-78532 Tuttlingen • Germany

Das bezeichnete Gerät, inklusive Zubehör entspricht den aufgeführten EG-Richtlinien und Normen.
The denoted device, including accessories corresponds to the listed EC guidelines and standards.
L'appareil désigné, y compris les accessoires, correspond aux directives CE et aux normes énumérées.
L'apparecchio designato, compresi gli accessori, è conforme alle direttive CE e alle norme citate.

Geräteart, Type of device, Type d'appareil, Tipo di apparecchio:

Laborzentrifuge mit Zubehör, Laboratory centrifuge with accessories, Centrifugeuse de laboratoire avec des accessoires, Centrifuga da laboratorio con accessori

Typenbezeichnung, Type designation, Désignation de modèle, Contrassegno tipo:

ROTOFIX 32 A

EG-Richtlinien/Normen, EC guidelines/standards, Directives CE/Normes, Direttive/Norme CEE:

2006/95/EG, EN 61010-1:2001, EN 61010-2-020:2006

2004/108/EG, EN 61326-1:2006

2006/42/EG, EN ISO 12100-1:2004, EN ISO 12100-2:2004

98/79/EG, EN 61010-2-101:2003

Tuttlingen, 28.09.2009

H. Eberle
Geschäftsleiter, Manager,
Directeur, Gerente



Andreas Hettich GmbH & Co. KG
Föhrenstraße 12, D-78532 Tuttlingen / Germany
Phone +49 (0)7461 / 705-0
Fax +49 (0)7461 / 705-125
info@hettichlab.com, service@hettichlab.com
www.hettichlab.com



© 2006 by Andreas Hettich GmbH & Co. KG

All rights reserved. No part of this publication may be reproduced without the prior written permission of the copyright owner.

Änderungen vorbehalten! , Modifications reserved! , Sous réserve de modifications ! , Con riserva di modifiche!

AB1206DEENFRIT / Rev. 00 / 12.09

Inhaltsverzeichnis

1	Bestimmungsgemäße Verwendung	6
2	Restrisiken	6
3	Technische Daten	6
4	Sicherheitshinweise	7
5	Bedeutung der Symbole	8
6	Lieferumfang	8
7	Auspacken der Zentrifuge	9
8	Inbetriebnahme	9
9	Deckel öffnen und schließen	9
9.1	Deckel öffnen	9
9.2	Deckel schließen	9
10	Ein- und Ausbau des Rotors	10
11	Beladen des Rotors	10
12	Bedien- und Anzeigeelemente	11
12.1	Symbole des Bedienfeldes	11
12.2	Tasten und Einstellmöglichkeiten	11
13	Bremsstufe einstellen	12
14	Zentrifugerradius einstellen	12
15	Zentrifugation	12
15.1	Zentrifugation mit Zeitvorwahl	13
15.2	Dauerlauf	13
15.3	Kurzzeitzentrifugation	13
15.4	Anzeige der relativen Zentrifugalbeschleunigung (RCF)	13
16	Relative Zentrifugalbeschleunigung (RCF)	14
17	Zentrifugation von Stoffen oder Stoffgemischen mit einer höheren Dichte als $1,2 \text{ kg/dm}^3$	14
18	Rotor-Erkennung	14
19	Notentriegelung	15
20	Pflege und Wartung	15
20.1	Zentrifuge (Gehäuse, Deckel und Schleuderraum)	15
20.1.1	Oberflächenreinigung und -pflege	15
20.1.2	Oberflächendesinfektion	15
20.1.3	Entfernen radioaktiver Verunreinigungen	16
20.2	Rotoren und Zubehör	16
20.2.1	Reinigung und Pflege	16
20.2.2	Desinfektion	16
20.2.3	Entfernen radioaktiver Verunreinigungen	16
20.2.4	Tragzapfen	16
20.2.5	Rotoren und Zubehör mit begrenzter Verwendungsdauer	17
20.3	Autoklavieren	17
20.4	Zentrifugiergefäße	17
21	Störungen	18
22	Netzeingangssicherungen wechseln	19
23	Reparaturannahme von Zentrifugen	19
24	Entsorgung	19
25	Anhang / Appendix	65
25.1	Rotoren und Zubehör / Rotors and accessories	65

1 Bestimmungsgemäße Verwendung

Bei der vorliegenden Maschine handelt es sich um ein Medizinprodukt (Laborzentrifuge) im Sinne der IVD-Richtlinie 98/79/EG. Die Zentrifuge dient zum Trennen von Stoffen bzw. Stoffgemischen mit einer Dichte von max. 1,2 kg/dm³. Darunter fallen auch Stoffe und Stoffgemische menschlichen Ursprungs. Die Zentrifuge ist nur für diesen Verwendungszweck bestimmt. Eine andere oder darüber hinausgehende Benutzung gilt als nicht bestimmungsgemäß. Für hieraus entstehende Schäden haftet die Firma Andreas Hettich GmbH & Co. KG nicht.

Zur bestimmungsgemäßen Verwendung gehört auch das Beachten aller Hinweise aus der Bedienungsanleitung und die Einhaltung der Inspektions- und Wartungsarbeiten.

2 Restrisiken

Die Maschine ist nach dem Stand der Technik und den anerkannten sicherheitstechnischen Regeln gebaut. Bei unsachgemäßer Verwendung und Behandlung können Gefahren für Leib und Leben des Benutzers oder Dritter bzw. Beeinträchtigungen an der Maschine oder an anderen Sachwerten entstehen. Die Maschine ist nur für die bestimmungsgemäße Verwendung, und nur in sicherheitstechnisch einwandfreiem Zustand zu benutzen.

Störungen, die die Sicherheit beeinträchtigen können, sind umgehend zu beseitigen.

3 Technische Daten

Hersteller	Andreas Hettich GmbH & Co. KG D-78532 Tuttlingen	
Modell	ROTOFIX 32 A	
Typ	1206	1206-01
Netzspannung ($\pm 10\%$)	208 – 240 V 1~	100 – 127 V 1~
Netzfrequenz	50 – 60 Hz	50 – 60 Hz
Anschlusswert	300 VA	300 VA
Stromaufnahme	1.4 A	3.0 A
Kapazität max.	4 x 100 ml / 32 x 15 ml	
zulässige Dichte	1.2 kg/dm ³	
Drehzahl (RPM)	6000	
Beschleunigung (RCF)	4186	
Kinetische Energie	3160 Nm	
Prüfpflicht (BGR 500)	nein	
Umgebungsbedingungen (EN / IEC 61010-1)	<p>nur in Innenräumen bis zu 2000 m über Normal-Null 2°C bis 40°C maximale relative Luftfeuchte 80% für Temperaturen bis 31°C, linear abnehmend bis 50% relativer Luftfeuchte bei 40°C.</p>	
– Aufstellungsort		
– Höhe		
– Umgebungstemperatur		
– Luftfeuchtigkeit		
– Überspannungskategorie (IEC 60364-4-443)	II	
– Verschmutzungsgrad	2	
Geräteschutzklasse	I	
nicht für den Einsatz in explosionsgefährdeter Umgebung geeignet.		
EMV		
– Störaussendung, Störfestigkeit	EN / IEC 61326-1, Klasse B	FCC Class B
Geräuschpegel (rotorabhängig)	≤ 57 dB(A)	
Abmessungen		
– Breite	366 mm	
– Tiefe	430 mm	
– Höhe	257 mm	
Gewicht	23 kg	

4 Sicherheitshinweise



Werden nicht alle Hinweise in dieser Bedienungsanleitung befolgt, kann beim Hersteller kein Gewährleistungsanspruch geltend gemacht werden.



- Die Zentrifuge ist so aufzustellen, dass sie standsicher betrieben werden kann.
- Vor Benutzung der Zentrifuge unbedingt den Rotor auf festen Sitz prüfen.
- Während eines Zentrifugationslaufes dürfen sich gemäß EN / IEC 61010-2-020, in einem Sicherheitsbereich von 300 mm um die Zentrifuge herum, keine Personen, Gefahrstoffe und Gegenstände befinden.
- Rotoren, Gehänge und Zubehörteile, die starke Korrosionsspuren oder mechanische Schäden aufweisen, oder deren Verwendungsdauer abgelaufen ist, dürfen nicht mehr verwendet werden.
- Die Zentrifuge darf nicht mehr in Betrieb genommen werden, wenn der Schleuderraum sicherheitsrelevante Schäden aufweist.
- Bei Ausschwingrotoren müssen die Tragzapfen regelmäßig gefettet werden (Hettich-Schmierfett Nr. 4051), um ein gleichmäßiges Ausschwingen der Gehänge zu gewährleisten.

- Vor Inbetriebnahme der Zentrifuge ist die Bedienungsanleitung zu lesen und zu beachten. Nur Personen, die die Bedienungsanleitung gelesen und verstanden haben, dürfen das Gerät bedienen.
- Neben der Bedienungsanleitung und den verbindlichen Regelungen der Unfallverhütung sind auch die anerkannten fachtechnischen Regeln für sicherheits- und fachgerechtes Arbeiten zu beachten. Die Bedienungsanleitung ist um Anweisungen aufgrund bestehender nationaler Vorschriften des Verwenderlandes zur Unfallverhütung und zum Umweltschutz zu ergänzen.
- Die Zentrifuge ist nach dem Stand der Technik gebaut und betriebssicher. Es können aber von ihr Gefahren für den Benutzer oder Dritte ausgehen, wenn sie nicht von geschultem Personal oder unsachgemäß oder zu nicht bestimmungsgemäßem Gebrauch eingesetzt wird.
- Die Zentrifuge darf während des Betriebs nicht bewegt oder angestoßen werden.
- Im Störfall bzw. bei der Notentriegelung nie in den sich drehenden Rotor greifen.
- Um Schäden durch Kondensat zu vermeiden, muss bei Wechsel von einem kalten in einen warmen Raum, die Zentrifuge entweder mindestens 3 Stunden im warmen Raum aufwärmen bevor sie an das Netz angeschlossen werden darf oder 30 Minuten im kalten Raum warmlaufen.
- Es dürfen nur die vom Hersteller für dieses Gerät zugelassenen Rotoren und das zugelassene Zubehör verwendet werden (siehe Kapitel "Anhang/Appendix, Rotoren und Zubehör/Rotors and accessories").
- Der Rotor der Zentrifuge darf nur entsprechend dem Kapitel "Beladen des Rotors" beladen werden.
- Bei der Zentrifugation mit maximaler Drehzahl darf die Dichte der Stoffe oder Stoffgemische $1,2 \text{ kg/dm}^3$ nicht überschreiten.
- Zentrifugationen mit unzulässiger Unwucht sind nicht erlaubt.
- Die Zentrifuge darf nicht in explosionsgefährdeter Umgebung betrieben werden.
- Eine Zentrifugation mit:
 - brennbaren oder explosiven Materialien
 - Materialien, die chemisch mit hoher Energie miteinander reagieren ist verboten.
- Bei der Zentrifugation von gefährlichen Stoffen bzw. Stoffgemischen, die toxisch, radioaktiv oder mit pathogenen Mikroorganismen verseucht sind, sind durch den Benutzer geeignete Maßnahmen zu treffen. Es müssen grundsätzlich Zentrifugiergefäße mit speziellen Schraubverschlüssen für gefährliche Substanzen verwendet werden. Bei Materialien der Risikogruppe 3 und 4 ist zusätzlich zu den verschließbaren Zentrifugiergefäßen ein Bio-Sicherheitssystem zu verwenden (siehe Handbuch "Laboratory Bio-safety Manual" der Weltgesundheitsorganisation). Bei einem Bio-Sicherheitssystem verhindert eine Bioabdichtung (Dichtring) das Austreten von Tröpfchen und Aerosolen. Wird das Gehänge eines Bio-Sicherheitssystems ohne den Deckel verwendet, muss der Dichtring vom Gehänge entfernt werden, um eine Beschädigung des Dichtrings während des Zentrifugationslaufes zu vermeiden. Beschädigte Dichtringe dürfen nicht mehr zum Abdichten des Bio-Sicherheitssystems verwendet werden.

Ohne Verwendung eines Bio-Sicherheitssystems ist eine Zentrifuge im Sinne der Norm EN / IEC 61010-2-020 nicht mikrobiologisch dicht.

Lieferbare Bio-Sicherheitssysteme siehe Kapitel "Anhang/Appendix, Rotoren und Zubehör/Rotors and accessories". Im Zweifelsfall sind entsprechende Informationen beim Hersteller einzuholen.

- Der Betrieb der Zentrifuge mit stark korrodierenden Stoffen, welche die mechanische Festigkeit von Rotoren, Gehäusen und Zubehörteilen beeinträchtigen können, ist nicht erlaubt.
- Reparaturen dürfen nur von einer vom Hersteller autorisierten Person ausgeführt werden.
- Es dürfen nur Originalersatzteile und zugelassenes Originalzubehör der Firma Andreas Hettich GmbH & Co. KG verwendet werden.
- Es gelten die folgenden Sicherheitsbestimmungen:
EN / IEC 61010-1 und EN / IEC 61010-2-020 sowie deren nationalen Abweichungen.
- Die Sicherheit und Zuverlässigkeit der Zentrifuge ist nur dann gewährleistet, wenn:
 - die Zentrifuge nach der Bedienungsanleitung betrieben wird.
 - die elektrische Installation, am Aufstellungsort der Zentrifuge, den Anforderungen von EN / IEC Festlegungen entspricht.
 - vorgeschriebene Prüfungen nach BGV A1, BGR 500 durch einen Sachkundigen durchgeführt werden.

5 Bedeutung der Symbole



Symbol an der Maschine:

Achtung, allgemeine Gefahrenstelle.

Vor Benutzung der Zentrifuge unbedingt die Bedienungsanleitung lesen und die sicherheitsrelevanten Hinweise beachten!



Symbol in diesem Dokument:

Achtung, allgemeine Gefahrenstelle.

Dieses Symbol kennzeichnet sicherheitsrelevante Hinweise und deutet auf mögliche gefährliche Situationen hin.

Das Nichtbeachten dieser Hinweise kann zu Sach- und Personenschäden führen.



Symbol an der Maschine und in diesem Dokument:

Warnung vor Biogefährdung.



Symbol in diesem Dokument:

Dieses Symbol deutet auf wichtige Sachverhalte hin.



Symbol an der Maschine und in diesem Dokument:

Symbol für die getrennte Sammlung von Elektro- und Elektronikgeräten, gemäß der Richtlinie 2002/96/EG (WEEE). Das Gerät gehört zur Gruppe 8 (Medizinische Geräte).

Verwendung in den Ländern der Europäischen Union sowie in Norwegen und der Schweiz.

6 Lieferumfang

Folgendes Zubehör wird mit der Zentrifuge geliefert:

- | | |
|---|---------------------------------|
| 1 | Anschlusskabel |
| 2 | Sicherungen |
| 1 | Schmierfett für Tragzapfen |
| 1 | Sechskantstiftschlüssel |
| 1 | Entriegelungsstift |
| 1 | Hinweisblatt Transportsicherung |
| 1 | Bedienungsanleitung |

Rotor(en) und das entsprechende Zubehör werden je nach Bestellung mitgeliefert.

7 Auspacken der Zentrifuge

- Den Karton nach oben abheben und die Polsterung entfernen.

-  Nicht an der Griffleiste des Deckels anheben.
Das Gewicht der Zentrifuge beachten, siehe Kapitel "Technische Daten".

Die Zentrifuge, mit der angemessenen Anzahl von Helfern, an beiden Seiten anheben und auf den Labortisch stellen.

8 Inbetriebnahme

- Gemäß der Laborgerätenorm EN / IEC 61010-2-020 muss in der Gebäudeinstallation ein Notausschalter zur Trennung der Netzversorgung im Fehlerfall angebracht sein. Dieser Schalter muss abseits der Zentrifuge angebracht sein, vorzugsweise außerhalb des Raumes, in dem sich die Zentrifuge befindet, oder neben dem Ausgang dieses Raumes.
- Die Transportsicherung am Gehäuseboden entfernen, siehe Hinweisblatt "Transportsicherung".
- **Die Zentrifuge an einem geeigneten Platz standsicher aufstellen und nivellieren. Bei der Aufstellung ist der geforderte Sicherheitsbereich gemäß EN / IEC 61010-2-020, von 300 mm um die Zentrifuge herum, einzuhalten.**

-  **Während eines Zentrifugationslaufes dürfen sich gemäß EN / IEC 61010-2-020, in einem Sicherheitsbereich von 300 mm um die Zentrifuge herum, keine Personen, Gefahrstoffe und Gegenstände befinden.**

- Lüftungsöffnungen dürfen nicht zugestellt werden. Es muss ein Lüftungsabstand von 300 mm um die Lüftungsschlitze oder Lüftungsöffnungen eingehalten werden.
- Prüfen ob die Netzspannung mit der Angabe auf dem Typenschild übereinstimmt.
- Die Zentrifuge mit dem Anschlusskabel an eine genormte Netzsteckdose anschließen. Anschlusswert siehe Kapitel "Technische Daten".
- Den Netzschalter einschalten. Schalterstellung "I". Die zuletzt benutzten Zentrifugierdaten werden angezeigt.
- Den Deckel öffnen.

9 Deckel öffnen und schließen

9.1 Deckel öffnen

-  Der Deckel lässt sich nur öffnen, wenn die Zentrifuge eingeschaltet ist und der Rotor stillsteht. Sollte dies nicht möglich sein, siehe Kapitel "Notentriegelung".

- Die Griffleiste am Deckel nach oben schwenken. In der Rotationsanzeige  leuchtet das Symbol "L" (Deckel geöffnet).
- Den Deckel öffnen.

9.2 Deckel schließen

-  Den Deckel nicht zuschlagen.

- Den Deckel auflegen und die Griffleiste am Deckel nach unten schwenken. In der Rotationsanzeige  leuchtet das Symbol "-" (Deckel geschlossen).

10 Ein- und Ausbau des Rotors

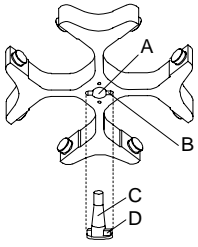

- Die Motorwelle (C) und die Bohrung des Rotors (A) reinigen und anschließend die Motorwelle leicht einfetten. Schmutzpartikel zwischen der Motorwelle und dem Rotor verhindern einen einwandfreien Sitz des Rotors und verursachen einen unruhigen Lauf.
- Den Rotor vertikal auf die Motorwelle aufsetzen. Der Mitnehmer der Motorwelle (D) muss sich in der Nut des Rotors (B) befinden. Auf dem Rotor ist die Ausrichtung der Nut gekennzeichnet.
- Die Spannmutter des Rotors mit dem mitgelieferten Schlüssel durch Drehen im Uhrzeigersinn anziehen.
- Den Rotor auf festen Sitz prüfen.
- Lösen des Rotors: Die Spannmutter durch Drehen entgegen dem Uhrzeigersinn lösen und bis zum Abhebe-Druckpunkt drehen. Nach Überwindung des Abhebe-Druckpunkts löst sich der Rotor vom Konus der Motorwelle. Die Spannmutter drehen, bis sich der Rotor von der Motorwelle abheben lässt.

11 Beladen des Rotors



Standard-Zentrifugiergefäße aus Glas sind belastbar bis RZB 4000 (DIN 58970 Teil 2).

- Den Rotor auf festen Sitz prüfen.
- Bei Ausschwingrotoren müssen alle Plätze des Rotors mit **gleichen** Gehängen besetzt sein. Bestimmte Gehänge sind mit der Nummer des Rotorplatzes gekennzeichnet. Diese Gehänge dürfen nur in den entsprechenden Platz des Rotors eingesetzt werden. Gehänge die mit einer Set-Nummer gekennzeichnet sind, z. B. S001/4, dürfen nur im Set verwendet werden.
- Die Rotoren und Gehänge dürfen nur symmetrisch beladen werden. Die Zentrifugiergefäße müssen gleichmäßig auf alle Plätze des Rotors verteilt werden. Zugelassene Kombinationen siehe Kapitel "Anhang/Appendix, Rotoren und Zubehör/Rotors and accessories".
Bei Winkelrotoren müssen alle möglichen Plätze des Rotors beladen werden, siehe Kapitel "Anhang/Appendix, Rotoren und Zubehör/Rotors and accessories".

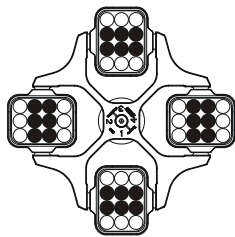

Rotor ist gleichmäßig beladen

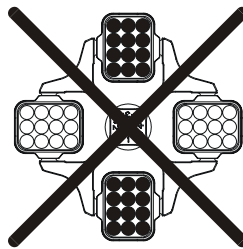

Nicht zulässig!

Rotor ist ungleichmäßig beladen

- Auf bestimmten Gehängen ist das Gewicht der maximalen Beladung oder das Gewicht der maximalen Beladung und das maximale Gewicht des komplett bestückten Gehänges angegeben. Diese Gewichte dürfen nicht überschritten werden. Im Ausnahmefall siehe Kapitel "Zentrifugation von Stoffen oder Stoffgemischen mit einer höheren Dichte als $1,2 \text{ kg/dm}^3$ ". Die Gewichtsangabe der maximalen Beladung umfasst das Gesamtgewicht von Reduzierung, Gestell, Zentrifugiergefäß und Inhalt.
- Bei Behältern mit Gummieinlagen muss sich unter den Zentrifugiergefäßen immer die gleiche Anzahl von Gummieinlagen befinden.
- Die Zentrifugiergefäße immer außerhalb der Zentrifuge befüllen.
- Es darf beim Füllen und beim Ausschwingen der Gehänge keine Flüssigkeit in den Schleuderraum gelangen.
- Die vom Hersteller angegebene maximale Füllmenge der Zentrifugiergefäße darf nicht überschritten werden.
- Um die Gewichtsunterschiede innerhalb der Zentrifugiergefäße möglichst gering zu halten, ist auf eine gleichmäßige Füllhöhe in den Gefäßen zu achten.

12 Bedien- und Anzeigeelemente

Siehe Abbildung auf Seite 2.

Fig. 2: Anzeige- und Bedienfeld

12.1 Symbole des Bedienfeldes



Rotationsanzeige. Die Rotationsanzeige leuchtet rotierend gegen den Uhrzeigersinn auf, solange sich der Rotor dreht.

Bei Stillstand des Rotors wird in der Rotationsanzeige durch Symbole der Zustand des Deckels angezeigt:

Symbol : Deckel geöffnet

Symbol : Deckel geschlossen

Bedienfehler und auftretende Störungen werden im Display angezeigt (siehe Kapitel "Störungen").

12.2 Tasten und Einstellmöglichkeiten

RPM/RCF x 100



- Drehzahl

Einstellbar ist ein Zahlenwert von 500 RPM bis zur maximalen Drehzahl des Rotors. Maximale Drehzahl des Rotors siehe Kapitel "Anhang/Appendix, Rotoren und Zubehör/Rotors and accessories". Einstellbar in 100er Schritten (RPM = angezeigter Wert x 100).

Bei Gedrückthalten der Taste oder ändert sich der Wert mit zunehmender Geschwindigkeit.

- Die Bremsstufe und den Zentrifugerradius anzeigen.

t



- Laufzeit

- Einstellbar von 1 - 99 Minuten, in 1 Minuten-Schritten

- Dauerlauf "--"

- Zentrifugerradius. Eingabe in Zentimeter. Einstellbar von 5 - 16 Zentimeter, in 1 Zentimeter-Schritten. Zentrifugerradius siehe Kapitel "Anhang/Appendix, Rotoren und Zubehör/Rotors and accessories".

- Bremsstufen 0 oder 1. Stufe 1 = kurze Auslaufzeit, Stufe 0 = lange Auslaufzeit.

Bei Gedrückthalten der Taste oder ändert sich der Wert mit zunehmender Geschwindigkeit.



- Zentrifugationslauf starten.



- Zentrifugationslauf beenden.
Der Rotor läuft mit vorgewählter Bremsstufe aus.
- Die Bremsstufe und den Zentrifugerradius speichern.



- Anzeige der relativen Zentrifugalbeschleunigung (RCF).
Die Anzeige der relativen Zentrifugalbeschleunigung (RCF) erfolgt, solange die Taste gedrückt gehalten wird.



- Kurzzeitzentrifugation.
Der Zentrifugationslauf erfolgt, solange die Taste gedrückt gehalten wird.
- Die Bremsstufe und den Zentrifugerradius anzeigen.

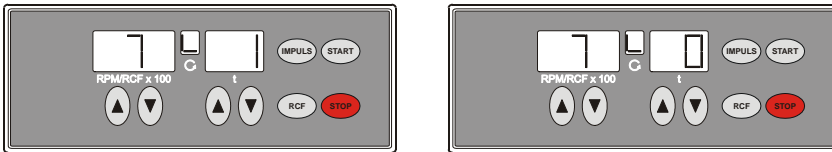

13 Bremsstufe einstellen

- Den Netzschalter ausschalten.
- Die Taste  unterhalb der Drehzahl-Anzeige und die Taste **IMPULS** gleichzeitig gedrückt halten.
- Den Netzschalter einschalten und die Tasten wieder loslassen.
In der Drehzahl-Anzeige wird die Maschinenversion und in der Zeit-Anzeige die eingestellte Bremsstufe angezeigt: z.B.:





Werden die Maschinenversion und die Bremsstufe nicht angezeigt, dann die Taste  unterhalb der Drehzahl-Anzeige so oft drücken, bis diese angezeigt werden.

Die Maschinenversion ist werksseitig eingestellt und kann nicht verändert werden.

- Mit den Tasten   unterhalb der Zeit-Anzeige die gewünschte Bremsstufe einstellen.
Stufe 1 = kurze Auslaufzeit, Stufe 0 = lange Auslaufzeit.
Auslaufzeiten siehe Kapitel "Anhang/Appendix, Rotoren und Zubehör/Rotors and accessories".
- Die Taste **STOP** drücken um die Einstellung zu speichern.



14 Zentrifugerradius einstellen

 Der Zentrifugerradius muss in Zentimeter eingegeben werden.

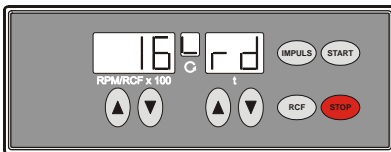
- Den Netzschalter ausschalten.
- Die Taste  unterhalb der Drehzahl-Anzeige und die Taste **IMPULS** gleichzeitig gedrückt halten.
- Den Netzschalter einschalten und die Tasten wieder loslassen.
- Die Taste  unterhalb der Drehzahl-Anzeige so oft drücken, bis folgende Anzeige erscheint:









In der Drehzahl-Anzeige wird der eingestellte Zentrifugerradius angezeigt.

- Mit den Tasten   unterhalb der Zeit-Anzeige den gewünschten Zentrifugerradius einstellen.
Zentrifugerradius siehe Kapitel "Anhang/Appendix, Rotoren und Zubehör/Rotors and accessories".
- Die Taste **STOP** drücken um die Einstellung zu speichern.

15 Zentrifugation

 Während eines Zentrifugationslaufes dürfen sich gemäß EN / IEC 61010-2-020, in einem Sicherheitsbereich von 300 mm um die Zentrifuge herum, keine Personen, Gefahrstoffe und Gegenstände befinden.

 Wird der zulässige Gewichtsunterschied innerhalb der Beladung des Rotors überschritten, schaltet der Antrieb während des Anlaufs ab, und Fehler **-3-** wird angezeigt (siehe Kapitel "Störungen").
Ein Zentrifugationslauf kann jederzeit durch Drücken der Taste **STOP** abgebrochen werden.
Die Zeit und die Drehzahl können während des Zentrifugationslaufes, mit den Tasten  , geändert werden.
Bei Gedrückthalten der Taste  oder  ändert sich der Wert mit zunehmender Geschwindigkeit.
Nach einem Zentrifugationslauf blinkt die Anzeige bis der Deckel geöffnet, oder eine Taste gedrückt wird.
Blinkt in der Rotationsanzeige  abwechselnd das Symbol "—" (Deckel geschlossen) und "L" (Deckel geöffnet), so ist eine weitere Bedienung der Zentrifuge erst nach einmaligem Öffnen des Deckels möglich.
Wird **rot xx** angezeigt, so hat kein Zentrifugationslauf stattgefunden, weil zuvor der Rotor gewechselt wurde, siehe Kapitel "Rotor-Erkennung".

- Den Netzschalter einschalten (Schalterstellung "I").
- Den Rotor beladen und den Zentrifugendeckel schließen.

15.1 Zentrifugation mit Zeitvorwahl

- Mit den Tasten ▲ ▼ unterhalb der Drehzahl-Anzeige die gewünschte Drehzahl einstellen.
- Mit den Tasten ▲ ▼ unterhalb der Zeit-Anzeige die gewünschte Zeit einstellen.
- Die Taste **START** drücken. Die Rotationsanzeige  erfolgt solange sich der Rotor dreht.



Die Zeit wird in Minuten angezeigt. Die letzte Minute wird in Sekunden heruntergezählt. Wird die Zeit in Minuten angezeigt, blinkt neben der Zahl ein Punkt.

- Nach Ablauf der Zeit oder bei Abbruch des Zentrifugationslaufes durch Drücken der Taste **STOP**, erfolgt der Auslauf des Rotors mit der eingestellten Bremsstufe.

Während des Zentrifugationslaufes werden die Drehzahl des Rotors oder der daraus resultierende RCF-Wert, und die verbleibende Zeit angezeigt.

15.2 Dauerlauf

- Mit den Tasten ▲ ▼ unterhalb der Drehzahl-Anzeige die gewünschte Drehzahl einstellen.
- Mit der Taste ▼ unterhalb der Zeit-Anzeige die Zeit auf Null stellen. Es wird "--" wird angezeigt.
- Die Taste **START** drücken. Die Rotationsanzeige  erfolgt solange sich der Rotor dreht. Die Zeitählung beginnt bei 0.



Die erste Minute wird in Sekunden hochgezählt, danach wird die Zeit in Minuten angezeigt. Wird die Zeit in Minuten angezeigt, blinkt neben der Zahl ein Punkt.

- Die Taste **STOP** drücken um den Zentrifugationslauf zu beenden. Der Auslauf des Rotors erfolgt mit der eingestellten Bremsstufe.

Während des Zentrifugationslaufes werden die Drehzahl des Rotors oder der daraus resultierende RCF-Wert, und die gelaufene Zeit angezeigt.

15.3 Kurzzeitentrifugation

- Mit den Tasten ▲ ▼ unterhalb der Drehzahl-Anzeige die gewünschte Drehzahl einstellen.
- Die Taste **IMPULS** gedrückt halten. Die Rotationsanzeige  erfolgt solange sich der Rotor dreht. Die Zeitählung beginnt bei 0.



Die erste Minute wird in Sekunden hochgezählt, danach wird die Zeit in Minuten angezeigt. Wird die Zeit in Minuten angezeigt, blinkt neben der Zahl ein Punkt.

- Die Taste **IMPULS** wieder loslassen um den Zentrifugationslauf zu beenden. Der Auslauf des Rotors erfolgt mit der eingestellten Bremsstufe.

Während des Zentrifugationslaufes werden die Drehzahl des Rotors und die gelaufene Zeit angezeigt.

15.4 Anzeige der relativen Zentrifugalbeschleunigung (RCF)

Während des Zentrifugationslaufes kann die relative Zentrifugalbeschleunigung (RCF) angezeigt werden.



Wird mit der relativen Zentrifugalbeschleunigung (RCF) gearbeitet, ist die Eingabe des Zentrifugierradius notwendig.

- Während des Zentrifugationslaufes die Taste **RCF** gedrückt halten. Die relative Zentrifugalbeschleunigung (RCF) erscheint in der Drehzahl-Anzeige (RCF = angezeigter Wert x 100).
- Die Taste **RCF** wieder loslassen. Es wird wieder die Drehzahl angezeigt.

16 Relative Zentrifugalbeschleunigung (RCF)

Die relative Zentrifugalbeschleunigung (RCF) wird als Vielfaches der Erdbeschleunigung (g) angegeben. Sie ist ein einheitsfreier Zahlenwert und dient zum Vergleich der Trenn- und Sedimentationsleistung.

Die Berechnung erfolgt nach der Formel:

$$\text{RCF} = \left(\frac{\text{RPM}}{1000} \right)^2 \times r \times 1,118 \quad \Rightarrow \quad \text{RPM} = \sqrt{\frac{\text{RCF}}{r \times 1,118}} \times 1000$$

RCF = Relative Zentrifugalbeschleunigung

RPM = Drehzahl

r = Zentrifugierradius in mm = Abstand von der Mitte der Drehachse bis zum Zentrifugiergefäßboden.
Zentrifugierradius siehe Kapitel "Anhang/Appendix, Rotoren und Zubehör/
Rotors and accessories".

 Die relative Zentrifugalbeschleunigung (RCF) ist von der Drehzahl und dem Zentrifugierradius abhängig.

17 Zentrifugation von Stoffen oder Stoffgemischen mit einer höheren Dichte als 1,2 kg/dm³

Bei der Zentrifugation mit maximaler Drehzahl darf die Dichte der Stoffe oder Stoffgemische 1,2 kg/dm³ nicht überschreiten.

Bei Stoffen oder Stoffgemischen mit einer höheren Dichte muss die Drehzahl reduziert werden.

Die erlaubte Drehzahl lässt sich nach folgender Formel berechnen:

$$\text{Reduzierte Drehzahl (n}_{\text{red}}) = \sqrt{\frac{1,2}{\text{höhere Dichte [kg/dm}^3]}} \times \text{maximale Drehzahl [RPM]}$$

z.B.: Maximale Drehzahl 4000 RPM, Dichte 1,6 kg/dm³

$$n_{\text{red}} = \sqrt{\frac{1,2 \text{ kg/dm}^3}{1,6 \text{ kg/dm}^3}} \times 4000 \text{ RPM} = 3464 \text{ RPM}$$

Wird im Ausnahmefall die, auf dem Gehänge angegebene, maximale Beladung überschritten, muss die Drehzahl ebenfalls reduziert werden.

Die erlaubte Drehzahl lässt sich nach folgender Formel berechnen:

$$\text{Reduzierte Drehzahl (n}_{\text{red}}) = \sqrt{\frac{\text{maximale Beladung [g]}}{\text{tatsächliche Beladung [g]}}} \times \text{maximale Drehzahl [RPM]}$$

z.B.: Maximale Drehzahl 4000 RPM, maximale Beladung 300 g, tatsächliche Beladung 350 g

$$n_{\text{red}} = \sqrt{\frac{300 \text{ g}}{350 \text{ g}}} \times 4000 \text{ RPM} = 3703 \text{ RPM}$$

Bei eventuellen Unklarheiten ist Auskunft beim Hersteller einzuholen.

18 Rotor-Erkennung

Nach jedem Start eines Zentrifugationslaufes wird der eingesetzte Rotor erkannt.

Nach einem Rotorwechsel schaltet der Antrieb ab und der Rotorcode (rot xx) des Rotors wird angezeigt.

- Die Taste **START** drücken. Die zuletzt benutzten Zentrifugierdaten werden angezeigt.

 Eine weitere Bedienung der Zentrifuge ist erst nach einmaligem Öffnen des Deckels möglich.
Wenn nach einem Rotorwechsel die maximale Drehzahl des Rotors kleiner als die eingestellte Drehzahl ist, wird die Drehzahl auf die maximale Drehzahl des Rotors begrenzt.

19 Notentriegelung

Bei einem Stromausfall kann der Deckel nicht geöffnet werden. Es muss eine Notentriegelung von Hand durchgeführt werden.



Zur Notentriegelung die Zentrifuge vom Netz trennen.
Den Deckel nur bei Stillstand des Rotors öffnen.
Zur Notentriegelung darf nur der, mitgelieferte Entriegelungsstift aus Kunststoff verwendet werden.

Siehe Abbildung auf Seite 2.

- Den Netzschalter ausschalten (Schalterstellung "0").
- Durch das Fenster im Deckel schauen, um sich zu vergewissern, dass der Rotor stillsteht.
- Den Entriegelungsstift (siehe Lieferumfang) waagrecht in die Bohrung einführen (Fig. 1, A). Den Entriegelungsstift so weit hineinschieben, bis sich beim nach unten Drücken des Stiftes die Griffleiste nach oben schwenken lässt.
- Den Deckel öffnen.

20 Pflege und Wartung



Das Gerät kann kontaminiert sein.



Vor der Reinigung den Netzstecker ziehen.
Bevor ein anderes als das vom Hersteller empfohlene Reinigungs- oder Dekontaminationsverfahren angewandt wird, hat sich der Benutzer beim Hersteller zu vergewissern, dass das vorgesehene Verfahren das Gerät nicht schädigt.

- Zentrifugen, Rotoren und das Zubehör dürfen nicht in Spülmaschinen gereinigt werden.
- Es darf nur eine Handreinigung und eine Flüssig-Desinfektion durchgeführt werden.
- Die Wassertemperatur muss 20 – 25°C betragen.
- Es dürfen nur Reinigungs- oder Desinfektionsmittel verwendet werden, die:
 - im pH-Bereich 5 - 8 liegen,
 - keine Ätzalkalien, Peroxide, Chlorverbindungen, Säuren und Laugen enthalten.
- Um Korrosionserscheinungen durch Reinigungs- oder Desinfektionsmittel zu vermeiden sind die speziellen Anwendungshinweise vom Hersteller des Reinigungs- oder Desinfektionsmittels unbedingt zu beachten.

20.1 Zentrifuge (Gehäuse, Deckel und Schleuderraum)

20.1.1 Oberflächenreinigung und -pflege

- Das Gehäuse der Zentrifuge und den Schleuderraum regelmäßig säubern und bei Bedarf mit Seife oder einem milden Reinigungsmittel und einem feuchten Tuch reinigen. Dies dient zum einen der Hygiene und es verhindert Korrosion durch anhaftende Verunreinigungen.
- Inhaltsstoffe geeigneter Reinigungsmittel:
Seife, anionische Tenside, nichtionische Tenside.
- Nach dem Einsatz von Reinigungsmitteln, die Reste des Reinigungsmittels, durch Nachwischen mit einem feuchten Tuch, entfernen.
- Die Flächen müssen unmittelbar nach der Reinigung getrocknet werden.
- Bei Bildung von Kondenswasser den Schleuderraum, durch Auswischen mit einem saugfähigen Tuch, trocknen.
- Die Gummidichtung des Schleuderraums nach jeder Reinigung mit Talkum-Puder oder einem Gummi-Pflegemittel leicht einreiben.
- Der Schleuderraum ist jährlich auf Schäden zu überprüfen.



Werden sicherheitsrelevante Schäden festgestellt, darf die Zentrifuge nicht mehr in Betrieb genommen werden. In diesem Fall ist der Kundendienst zu benachrichtigen.

20.1.2 Oberflächendesinfektion

- Gelangt infektiöses Material in den Schleuderraum, so ist dieser umgehend zu desinfizieren.
- Inhaltsstoffe geeigneter Desinfektionsmittel:
Äthanol, n-Propanol, Isopropanol, Glutaraldehyd, quaternäre Ammoniumverbindungen.
- Nach dem Einsatz von Desinfektionsmitteln, die Reste des Desinfektionsmittels, durch Nachwischen mit einem feuchten Tuch, entfernen.
- Die Flächen müssen unmittelbar nach der Desinfektion getrocknet werden.

20.1.3 Entfernen radioaktiver Verunreinigungen

- Das Mittel muss speziell für das Entfernen radioaktiver Verunreinigungen ausgewiesen sein.
- Inhaltsstoffe geeigneter Mittel für das Entfernen radioaktiver Verunreinigungen:
Anionische Tenside, nichtionische Tenside, polyhydrierter Äthanol.
- Nach dem Entfernen der radioaktiven Verunreinigungen, die Reste des Mittels, durch Nachwischen mit einem feuchten Tuch, entfernen.
- Die Flächen müssen unmittelbar nach dem Entfernen der radioaktiven Verunreinigungen getrocknet werden.

20.2 Rotoren und Zubehör

20.2.1 Reinigung und Pflege

- Um einer Korrosion und Materialveränderungen vorzubeugen müssen die Rotoren und die Zubehörteile regelmäßig mit Seife oder einem milden Reinigungsmittel und einem feuchten Tuch gereinigt werden. Die Reinigung wird mindestens einmal wöchentlich empfohlen. Verschmutzungen müssen sofort entfernt werden.
- Inhaltsstoffe geeigneter Reinigungsmittel:
Seife, anionische Tenside, nichtionische Tenside.
- Nach dem Einsatz von Reinigungsmitteln, die Reste des Reinigungsmittels, durch Nachspülen mit Wasser (nur außerhalb der Zentrifuge) oder Nachwischen mit einem feuchten Tuch, entfernen.
- Die Rotoren und das Zubehör müssen unmittelbar nach der Reinigung getrocknet werden.
- Winkelrotoren, Behälter und Gehänge aus Aluminium sind nach dem Trocknen mit säurefreiem Fett z.B. Vaseline leicht einzufetten.
- Bei Bio-Sicherheitssystemen (lieferbare Bio-Sicherheitssysteme siehe Kapitel "Anhang/Appendix, Rotoren und Zubehör/Rotors and accessories") sind die Dichtungsringe regelmäßig (wöchentlich) zu prüfen und zu reinigen. Bei Anzeichen von Rissbildung, Versprödung oder Abnutzung ist der Dichtungsring sofort auszutauschen. Um ein Verdrehen des Dichtungsringes während dem Öffnen und Schließen des Deckels zu vermeiden, muss der Dichtungsring mit Talkum-Puder oder einem Gummi-Pflegemittel leicht eingerieben werden.
- Um Korrosion infolge Feuchtigkeit zwischen Rotor und Motorwelle zu verhindern, sollte der Rotor mindestens einmal im Monat ausgebaut, gereinigt und die Motorwelle leicht gefettet werden.
- Die Rotoren und die Zubehörteile sind monatlich auf Verschleiß und Korrosionsschäden zu überprüfen. Bei Ausschwingrotoren muss vor allem der Bereich der Tragzapfen und bei Gehängen die Nuten und der Boden auf Risse geprüft werden.



Rotoren und Zubehör dürfen bei Anzeichen von Verschleiß oder Korrosion nicht mehr verwendet werden.

- Den Rotor wöchentlich auf festen Sitz prüfen.

20.2.2 Desinfektion

- Gelangt infektiöses Material auf die Rotoren oder auf das Zubehör, so muss eine geeignete Desinfektion durchgeführt werden.
- Inhaltsstoffe geeigneter Desinfektionsmittel:
Glutaraldehyd, Propanol, Ethylhexanol, anionische Tenside, Korrosionsinhibitoren.
- Nach dem Einsatz von Desinfektionsmitteln, die Reste des Desinfektionsmittels, durch Nachspülen mit Wasser (nur außerhalb der Zentrifuge) oder Nachwischen mit einem feuchten Tuch, entfernen.
- Die Rotoren und das Zubehör müssen unmittelbar nach der Desinfektion getrocknet werden.

20.2.3 Entfernen radioaktiver Verunreinigungen

- Das Mittel muss speziell für das Entfernen radioaktiver Verunreinigungen ausgewiesen sein.
- Inhaltsstoffe geeigneter Mittel für das Entfernen radioaktiver Verunreinigungen:
Anionische Tenside, nichtionische Tenside, polyhydrierter Äthanol.
- Nach dem Entfernen der radioaktiven Verunreinigungen, die Reste des Mittels, durch Nachspülen mit Wasser (nur außerhalb der Zentrifuge) oder Nachwischen mit einem feuchten Tuch, entfernen.
- Die Rotoren und das Zubehör müssen unmittelbar nach dem Entfernen der radioaktiven Verunreinigungen getrocknet werden.

20.2.4 Tragzapfen

Bei Ausschwingrotoren müssen die Tragzapfen regelmäßig gefettet werden (Hettich-Schmierfett Nr. 4051), um ein gleichmäßiges Ausschwingen der Gehänge zu gewährleisten.

20.2.5 Rotoren und Zubehör mit begrenzter Verwendungsdauer

Die Verwendung von bestimmten Rotoren, Gehängen und Zubehörteilen ist zeitlich begrenzt.

Diese sind mit der maximal erlaubten Anzahl der Lauf-Zyklen oder dem Ablaufdatum und der maximalen Anzahl der Lauf-Zyklen oder nur mit dem Ablaufdatum gekennzeichnet, z.B.:

- "einsetzbar bis Ende: IV. Quartal 2011 / usable until end of: IV. Quartal 2011" oder
"einsetzbar bis Ende Monat/Jahr: 10/2011 / usable until end of month/year: 10/2011"
- "max. Laufzyklen / max. cycles: 40000".



Aus Sicherheitsgründen dürfen die Rotoren, Gehänge und Zubehörteile nicht mehr verwendet werden, wenn entweder die darauf gekennzeichnete maximal erlaubte Anzahl der Lauf-Zyklen oder das darauf gekennzeichnete Ablaufdatum erreicht ist.

20.3 Autoklavieren

Ausschwingrotoren, Winkelrotoren aus Aluminium, Gehänge aus Metall, Deckel mit Bioabdichtung sowie Gestelle und Reduzierungen können bei 121°C / 250°F (20 min) autoklaviert werden.

Im Zweifelsfall muss beim Hersteller nachgefragt werden.

Über den Sterilitätsgrad kann keine Aussage gemacht werden.



Die Deckel der Rotoren und Behälter müssen vor dem Autoklavieren abgenommen werden.

Das Autoklavieren beschleunigt den Alterungsprozess von Kunststoffen. Außerdem kann es bei Kunststoffen Farbveränderungen verursachen.

Wir empfehlen nach dem Autoklavieren die Dichtungsringe von Bio-Sicherheitssystemen auszutauschen.

20.4 Zentrifugiergefäße

- Bei Undichtigkeit oder nach dem Bruch von Zentrifugiergefäßen, sind zerbrochene Gefäßteile, Glassplitter und ausgelaufenes Zentrifugiergut vollständig zu entfernen.
- Die Gummieinlagen sowie die Kunststoff-Hülsen der Rotoren sind nach einem Glasbruch zu ersetzen.



Verbleibende Glassplitter verursachen weiteren Glasbruch !

- Handelt es sich um infektiöses Material so ist umgehend eine Desinfektion durchzuführen.

21 Störungen

Lässt sich der Fehler laut Störungstabelle nicht beheben, so ist der Kundendienst zu benachrichtigen.

Bitte den Zentrifugentyp und die Seriennummer angeben. Beide Nummern sind auf dem Typenschild der Zentrifuge ersichtlich.



Einen NETZ-RESET durchführen:

- Den Netzschalter ausschalten (Schalterstellung "0").
- Mindestens 10 Sekunden lang warten und anschließend den Netzschalter wieder einschalten (Schalterstellung "I").

Störung	Anzeige	Fehlerursache	Beseitigung
keine Anzeige	---	Keine Spannung. Netzeingangssicherungen defekt.	<ul style="list-style-type: none"> - Versorgungsspannung überprüfen. - Netzeingangssicherungen überprüfen, siehe Kapitel "Netzeingangssicherungen wechseln". - Netzschalter EIN.
Tachofehler	- 1 -	Ausfall der Drehzahlimpulse.	<ul style="list-style-type: none"> - Der Deckel lässt sich aus Sicherheitsgründen erst nach ca. 120 Sekunden öffnen. - Nach Ablauf dieser Zeit einen "NETZ-RESET" durchführen.
NETZ-RESET	- 2 -	Netzunterbrechung während des Zentrifugationslaufes. (Der Zentrifugationslauf wurde nicht beendet.)	<ul style="list-style-type: none"> - Nach Stillstand Deckel öffnen und Taste START betätigen. - Bei Bedarf den Zentrifugationslauf wiederholen.
Unwucht	- 3 -	Der Rotor ist ungleichmäßig beladen.	<ul style="list-style-type: none"> - Deckel nach Rotor-Stillstand öffnen. - Die Beladung des Rotors überprüfen, siehe Kapitel "Beladen des Rotors". - Den Zentrifugationslauf wiederholen.
Kommunikation	- 4 -	Fehler im Steuerteil oder Leistungsteil.	<ul style="list-style-type: none"> - Nach Stillstand des Rotors einen NETZ-RESET durchführen.
Überlast	- 5 -	Motor oder Motoransteuerung defekt.	<ul style="list-style-type: none"> - Nach Stillstand des Rotors einen NETZ-RESET durchführen.
Überspannung Unterspannung	- 6 - - 8 -	Netzspannung außerhalb der Toleranzen (siehe Technische Daten).	<ul style="list-style-type: none"> - Nach Stillstand des Rotors einen NETZ-RESET durchführen. - Netzspannung kontrollieren.
Überdrehzahl	- 7 -	Fehler im Leistungsteil.	<ul style="list-style-type: none"> - Nach Stillstand des Rotors einen NETZ-RESET durchführen.
Übertemperatur	- 9 -	Übertemperaturschalter im Motor hat ausgelöst.	<ul style="list-style-type: none"> - Nach Rotor-Stillstand Deckel durch Notentriegelung öffnen (siehe Kapitel Notentriegelung). - Motor abkühlen lassen.
Version Error	In der Zeit-Anzeige wird eine Zahl angezeigt.	Falsche Maschinenversion eingestellt, Steuerteil springt in das Einstell-Menü.	<ul style="list-style-type: none"> - Mit den Tasten ▲ ▼ unterhalb der Zeit-Anzeige die Zahl 4 einstellen. - Die Taste STOP drücken um die Einstellung zu speichern. - Einen NETZ-RESET durchführen.
Controller-Watchdog	- C -	Fehler im Steuerteil.	<ul style="list-style-type: none"> - Nach Stillstand des Rotors einen NETZ-RESET durchführen.
Deckelfehler	- d -	Fehler Deckelverriegelung.	<ul style="list-style-type: none"> - Nach Stillstand des Rotors einen NETZ-RESET durchführen.
Kurzschluss	- E -	Kurzschluss in Steuerteil / Leistungsteil.	<ul style="list-style-type: none"> - Nach Stillstand des Rotors einen NETZ-RESET durchführen.
Kein Rotorcode	- F -	Keine Rotorerkennung beim Start. Kein Rotor eingesetzt oder defekter Tacho.	<ul style="list-style-type: none"> - Nach Stillstand des Rotors einen NETZ-RESET durchführen.
Neuer Rotor erkannt	rot...	siehe Kapitel "Rotorerkennung".	<ul style="list-style-type: none"> - Die Taste START drücken.

22 Netzeingangssicherungen wechseln



Den Netzschalter ausschalten und die Zentrifuge vom Netz trennen!

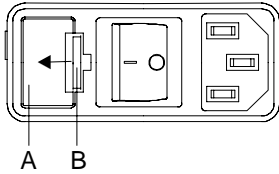

Der Sicherungshalter (A) mit den Netzeingangssicherungen befindet sich neben dem Netzschalter.

- Das Anschlusskabel aus dem Gerätestecker ziehen.
- Den Schnappverschluss (B) gegen den Sicherungshalter (A) drücken und diesen herausziehen.
- Defekte Netzeingangssicherungen austauschen.



Nur Sicherungen mit dem, für den Typ, festgelegten Nennwert verwenden, siehe nachfolgende Tabelle.

- Den Sicherungshalter wieder hineinschieben bis der Schnappverschluss einrastet.
- Die Zentrifuge wieder ans Netz anschließen.

Modell	Typ	Sicherung	Best.-Nr.
ROTOFIX 32 A	1206	T 3,15 AH/250V	E997
ROTOFIX 32 A	1206-01	T 5 AH/250V	E914

23 Reparaturannahme von Zentrifugen

Wird die Zentrifuge zur Reparatur an den Hersteller zurückgesandt, so muss diese, zum Schutz von Personen, Umwelt und Material, vor dem Versand dekontaminiert und gereinigt werden.

Eine Annahme von kontaminierten Zentrifugen behalten wir uns vor.

Anfallende Kosten für Reinigungs- und Desinfektionsmaßnahmen werden dem Kunden in Rechnung gestellt.

Wir bitten dafür um Ihr Verständnis.

24 Entsorgung

Vor der Entsorgung muss das Gerät, zum Schutz von Personen, Umwelt und Material, dekontaminiert und gereinigt werden.

Bei der Entsorgung des Geräts sind die jeweiligen gesetzlichen Vorschriften zu beachten.

Gemäß der Richtlinie 2002/96/EG (WEEE) dürfen alle nach dem 13.08.2005 gelieferten Geräte nicht mehr mit dem Hausmüll entsorgt werden. Das Gerät gehört zur Gruppe 8 (Medizinische Geräte) und ist in den Business-to-Business-Bereich eingeordnet.



Mit dem Symbol des durchgestrichenen Abfalleimers wird darauf hingewiesen, dass das Gerät nicht mit dem Hausmüll entsorgt werden darf.

Die Entsorgungsvorschriften der einzelnen EU-Länder können unterschiedlich sein. Im Bedarfsfall wenden Sie sich bitte an Ihren Lieferanten.

Contents

1	Use according to specification	21
2	Residual risks.....	21
3	Technical specifications	21
4	Notes on safety	22
5	Symbol meanings.....	23
6	Delivery checklist	23
7	Unpacking the centrifuge	24
8	Initial operation.....	24
9	Opening and closing the lid.....	24
9.1	Opening the lid.....	24
9.2	Closing the lid.....	24
10	Installation and removal of the rotor.....	25
11	Loading the rotor	25
12	Control and display elements.....	26
12.1	Symbols on the control panel.....	26
12.2	Keys and setting options.....	26
13	Setting the brake step	27
14	Setting the centrifuging radius.....	27
15	Centrifugation	27
15.1	Centrifugation with preselected time.....	28
15.2	Continuous operation.....	28
15.3	Short-time centrifugation.....	28
15.4	Display of the relative centrifugal force (RCF)	28
16	Relative centrifugal force (RCF).....	28
17	Centrifugation of materials or mixtures of materials with a density higher than 1.2 kg/dm ³	29
18	Rotor Identification	29
19	Emergency release	29
20	Maintenance and servicing	30
20.1	Centrifuge (housing, lid and centrifuging chamber)	30
20.1.1	Surface cleaning and care	30
20.1.2	Surface disinfection.....	30
20.1.3	Removal of radioactive contaminants	30
20.2	Rotors and Attachments	31
20.2.1	Cleaning and care.....	31
20.2.2	Disinfection	31
20.2.3	Removal of radioactive contaminants.....	31
20.2.4	Trunnions	31
20.2.5	Rotors and accessories with limited service lives.....	32
20.3	Autoclaving	32
20.4	Centrifuge containers.....	32
21	Faults.....	33
22	Change mains input fuse	34
23	Acceptance of the centrifuges for repair	34
24	Disposal.....	34
25	Anhang / Appendix.....	65
25.1	Rotoren und Zubehör / Rotors and accessories	65

1 Use according to specification

The machine presented here is a medical product (laboratory centrifuge) according to the IVD guideline 98/79/EG. The centrifuge is used to separate substances or substance mixtures with a density of max. 1.2 kg/dm³. This also includes substances and substance mixtures of human origin. The centrifuge is only intended to be used for this purpose. A different use or application over and above this is deemed not in accordance with the specifications. The company Andreas Hettich GmbH & Co. KG undertakes no liability for damages resulting therefrom.

Belonging to the application according to specification is also the observance of all references contained in the Instruction Manual and compliance with the inspection and maintenance works.

2 Residual risks

The machine is constructed according to the state of the art and the recognized technical safety regulations. Improper use and handling can result in dangers to life and limb of the user or third parties and impairments to the machine or to other material assets. The machine is only to be used for the specified applications and only in an impeccable technical safety condition.

Disturbances that can interfere with the safety are to be immediately rectified.

3 Technical specifications

Manufacturer	Andreas Hettich GmbH & Co. KG D-78532 Tuttlingen	
Model	ROTOFIX 32 A	
Type	1206	1206-01
Mains voltage (± 10%)	208 – 240 V 1~	100 – 127 V 1~
Mains frequency	50 – 60 Hz	50 – 60 Hz
Connected load	300 VA	300 VA
Current consumption	1.4 A	3.0 A
Max. capacity	4 x 100 ml / 32 x 15 ml	
Allowed density	1.2 kg/dm ³	
Speed (RPM)	6000	
Force (RCF)	4186	
Kinetic energy	3160 Nm	
Obligatory inspection (BGR 500)	no	
Ambient conditions (EN / IEC 61010-1)	<ul style="list-style-type: none"> – Set-up site Indoors only – Altitude Up to 2000 m above sea level – Ambient temperature 2°C to 40°C – Humidity Maximum relative humidity 80% for temperatures up to 31°C, linearly decreasing to 50% relative humidity at 40°C. – Excess-voltage category (IEC 60364-4-443) II – Pollution degree 2 	
Device protection class	I	
Not suitable for use in explosion-endangered areas.		
EMC	<ul style="list-style-type: none"> – Emitted interference, Interference immunity EN / IEC 61326-1, Class B FCC Class B 	
Noise level (dependent on rotor)	≤ 57 dB(A)	
Dimensions	<ul style="list-style-type: none"> – Width 366 mm – Depth 430 mm – Height 257 mm 	
Weight	23 kg	

4 Notes on safety



No claim of warranty will be considered by the manufacturer unless ALL instructions in this manual have been followed.



- **The centrifuge should be installed on a good, stable base.**
- **Before using the centrifuge absolutely check the rotor for firm placement.**
- **When the centrifuge is running, according to EN / IEC 61010-2-020, no persons, dangerous substances or objects may be within the safety margin of 300 mm around the centrifuge.**
- **Rotors, suspensions and accessories that possess traces of corrosion or mechanical damage or if their term of use has expired may not be used any longer.**
- **The centrifuge may no longer be put into operation when the centrifuging chamber has safety-related damages.**
- **With swing-out rotors the trunnions must be regularly lubricated (Hettich Lubricating Grease No. 4051) in order to ensure consistent swinging out of the hangers.**

- **Before the initial operation of your centrifuge you should read and pay attention to the operating instructions. Only personnel that has read and understood the operating instructions are allowed to operate the device.**
- Along with the operating instructions and the legal regulations on accident prevention, you should also follow the recognised professional regulations for working in a safe and professional manner. These operating instructions should be read in conjunction with any other instructions concerning accident prevention and environmental protection based on the national regulations of the country where the device is to be used.
- This centrifuge is a state-of-the-art piece of equipment which is extremely safe to operate. However, it can lead to danger for users or others if used by untrained staff, in an inappropriate way or for a purpose other than that it was designed for.
- The centrifuge must not be moved or knocked during operation.
- In case of fault or emergency release, never touch the rotor before it has stopped turning.
- To avoid damage due to condensate, when changing from a cold to a warm room the centrifuge must either heat up for at least 3 hours in the warm room before being connected to the mains, or run hot for 30 minutes in the cold room.
- Only the rotors and accessories approved by the manufacturer for this device may be used (see chapter "Anhang/Appendix, Rotoren und Zubehör/Rotors and accessories").
- The centrifuge rotor may only be loaded in accordance with the chapter "Loading the rotor".
- When centrifuging with maxim revolutions per minute the density of the materials or the material mixtures may not exceed 1.2 kg/dm³.
- The centrifuge may only be operated when the balance is within the bounds of acceptability.
- The centrifuge may not be operated in explosion-endangered areas.
- The centrifuge must not be used with:
 - inflammable or explosive materials
 - materials that react with one another producing a lot of energy.
- If users have to centrifuge hazardous materials or compounds contaminated with toxic, radioactive or pathogenic micro-organisms, they must take appropriate measures.
 For hazardous substances centrifuge containers with special screw caps must strictly be used. In addition to the screw cap centrifuge containers, for materials in hazard category 3 and 4 a biosafety system must be used (see the World Health Organisation's "Laboratory Biosafety Manual").
 In a biosafety system, droplets and aerosols are prevented from escaping by a bioseal (packing ring).
 If the hanger of a biosafety system is used without the lid, the packing ring must be removed from the hanger in order to prevent the packing ring from being damaged during the centrifugation run. Damaged packing rings must not be used to seal the biosafety system.
 Without the use of a biosafety system the centrifuge is not microbiologically sealed in the sense of the EN / IEC 610101-2-020 standard.

For further details of available biosafety systems see chapter "Anhang/Appendix, Rotoren und Zubehör/Rotors and accessories". If in doubt, you should obtain relevant information from the manufacturer.

- The centrifuge must not be operated with highly corrosive substances which could impair the mechanical integrity of rotors, hangers and accessories.
- Repairs must only be carried out by personnel authorised to do so by the manufacturer.
- Only original spare parts and original accessories licensed by the Andreas Hettich GmbH & Co. KG company are allowed to be utilised.
- The following safety regulations apply:
EN / IEC 61010-1 and EN / IEC 61010-2-020 as well as their national deviations.
- The safe operation and reliability of the centrifuge can only be guaranteed if:
 - the centrifuge is operated in accordance with the operating instructions,
 - the electrical installation on the site where the centrifuge is installed conforms to the demands of EN / IEC stipulations,
 - prescribed tests to BGV A1, BGR 500 are carried out by an expert.

5 Symbol meanings



Symbol on the machine:

Attention, general hazard area.

Before using the centrifuge implicitly read the operating instructions and pay attention to the safety relevant references!



Symbol in this document:

Attention, general hazard area.

This symbol refers to safety relevant warnings and indicates possibly dangerous situations.

The non-adherence to these warnings can lead to material damage and injury to personal.



Symbol on the machine and in this document:

Beware of biohazard.



Symbol in this document:

This symbol refers to important circumstances.



Symbol on the machine and in this document:

Symbol for the separate collection of electric and electronic devices according to the guideline 2002/96/EG (WEEE). The device belongs to Group 8 (medical devices).

Applies in the countries of the European Union, as well as in Norway and Switzerland.

6 Delivery checklist

The following items and accessories are delivered with the centrifuge:

- | | |
|---|--------------------------------------|
| 1 | Connecting cable |
| 2 | Fuses |
| 1 | Lubricating grease for trunnions |
| 1 | Hex. pin driver |
| 1 | Release pin |
| 1 | Notes on moving the equipment safely |
| 1 | Operating instructions |

The rotor(s) and associated accessories are included in the delivery in the quantity.

7 Unpacking the centrifuge

- Lift the carton upward and remove the padding.

-  Do not lift by the handle rail.
Observe the weight of the centrifuge, refer to chapter "Technical specifications".

Lift the centrifuge on both sides with an appropriate number of helpers and place it on the laboratory table.

8 Initial operation

- According to the laboratory instrument standards IEC 61010-2-020 an emergency switch to separate power supply in the event of a failure must be installed in the building electrical system.
This switch has to be placed remote from the centrifuge, preferred outside of the room in which the centrifuge is installed or near by the exit of this room.
- Remove the transportation safety device from the bottom of the housing, see sheet "Transportation safety device".
- **Position the centrifuge in a stable and level manner in a suitable place. During set-up, the required safety margin of 300 mm around the centrifuge is to be kept according to EN / IEC 61010-2-020.**

 **When the centrifuge is running, according to EN / IEC 61010-2-020, no persons, dangerous substances or objects may be within the safety margin of 300 mm around the centrifuge.**

- Do not place any object in front of the ventiduct.
Keep a ventilation area of 300 mm around the ventiduct.
- Check whether the mains voltage tallies with the statement on the type plate.
- Connect the centrifuge with the connection cable to a standard mains socket. For connection ratings refer to Chapter "Technical specifications".
- Turn on the mains switch. Switch position "I".
The last used centrifuge data will be displayed.
- Open the lid.

9 Opening and closing the lid

9.1 Opening the lid

 The lid can only be opened when the centrifuge is switched on and the rotor is at rest. If it cannot be opened under these circumstances, see the section on "Emergency release".

- Swing handle rail on the lid upwards. The symbol "L" (lid open) illuminates in the rotation indicator .
- Open the lid.

9.2 Closing the lid

 Do not bang the lid shut.

- Place the lid and swing handle rail on the lid downward. The symbol "—" (lid closed) illuminates in the rotation indicator .

10 Installation and removal of the rotor

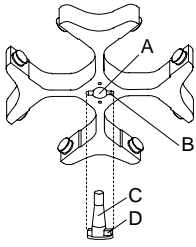

- Clean the motor shaft (C) and the rotor drilling (A), and lightly grease the motor shaft afterwards. Dirt particles between the motor shaft and the rotor hinder a perfect seating of the rotor and cause an irregular operation.
- Place the rotor vertically on the motor shaft. The motor shaft dog (D) has to fit in the rotor slot (B). The alignment of the groove is labelled on the rotor.
- Tighten the rotor tension nut with the supplied wrench by turning in a clockwise direction.
- Check the rotor for firm seating.
- Loosening the rotor: Loosen the tension nut by turning in a counter clockwise direction, and turning until the working point for lifting. After passing the working point for lifting the rotor is loosened from the motor shaft cone. Turn the tension nut until the rotor is able to be lifted from the motor shaft.

11 Loading the rotor



Standard centrifuge containers of glass will not stand RCF values exceeding 4000 (DIN 58970, pg. 2).

- Check the rotor for firm seating.
With swing-out rotors all rotor positions must be lined with **identical** hangers. Certain hangers are marked with the number of the rotor position. These hangers may only be used in the respective rotor position. Hangers that are marked with a set number (e.g. S001/4) may only be used in the set.
- The rotors and hangers may only be loaded symmetrically. The centrifuge containers have to be distributed evenly on all rotor positions. For authorised combinations see Chapter "Anhang/Appendix, Rotoren und Zubehör/Rotors and accessories".
In the case of angle rotors all possible rotor positions must be loaded, see chapter "Anhang/Appendix, Rotoren und Zubehör/Rotors and accessories".

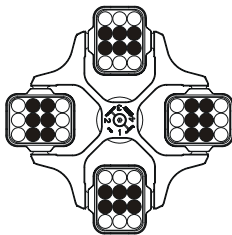

Rotor is evenly loaded

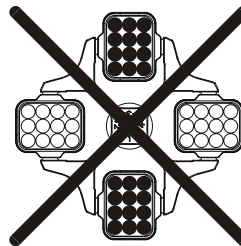

Not permitted!
Rotor is not evenly loaded

- On certain hangers, the weight of the maximum load or the weight of the maximum load and the maximum weight of the completely loaded hanger is specified. This weight may not be exceeded. In case of exception, see chapter "Centrifugation of materials or mixtures of materials with a density higher than 1.2 kg/dm³". The weight specified for the maximum loading includes the total weight of adapter, frame, centrifuging container and content.
- In containers with rubber inserts, the same number of rubber inserts must always be among the centrifuge containers.
- Always fill the centrifuge containers outside of the centrifuge.
- No liquid should be allowed to enter the centrifugal chamber during filling and swinging out of the hangers.
- The maximum filling quantity for the centrifuge containers specified by the manufacturer must not be exceeded.
- In order to maintain the weight differences within the centrifuge container as marginal as possible, a consistent fill level in the containers is to be heeded.

12 Control and display elements

See figure on page 2.

Fig. 2: Display and control panel

12.1 Symbols on the control panel



Rotation indicator. The rotation indicator lights up and rotates anticlockwise while the rotor is turning.

When the rotor is stationary, the status of the lid is displayed by symbols in the rotation indicator:

Symbol  : Lid open

Symbol  : Lid closed

Operator errors and occurring faults are indicated on the display (see Chapter "Faults").



12.2 Keys and setting options

RPM/RCF x 100



- Speed

A numeric value of 500 RPM up to the maximum rotor speed can be set. For maximum rotor speed, see chapter "Anhang/Appendix, Rotoren und Zubehör/Rotors and accessories". Preset in steps of 100 (RPM = displayed value x 100).

If the key  or  is kept pressed, the value changes with increasing speed.

- Display the brake step and the centrifuging radius.

t



- Running time

- Preset from 1 - 99 minutes, in 1 minute steps

- Continuous operation "--"

- Centrifuging radius. Input in centimeters. Preset from 5 - 16 centimeters, in 1 centimeter steps. For centrifuging radius, see chapter "Anhang/Appendix, Rotoren und Zubehör/Rotors and accessories".
- Braking steps 0 or 1. Step 1 = short run-down time, Step 0 = long run-down time.

If the key  or  is kept pressed, the value changes with increasing speed.

START

- Start centrifugation run.

STOP

- End centrifugation run.
The rotor runs down with the preselected brake step.
- Save the brake step and the centrifuging radius.

RCF

- Display of the relative centrifugal force (RCF).
The display of the relative centrifugal force (RCF) appears while the key  is kept pressed.



- Short-time centrifugation.
The centrifugation run occurs while the key  is kept pressed.
- Display the brake step and the centrifuging radius.

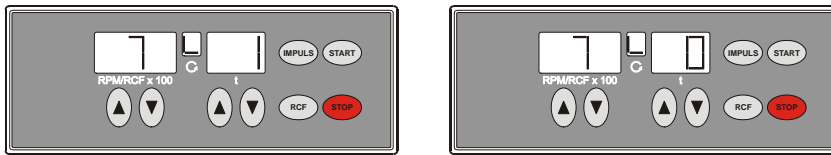

13 Setting the brake step

- Switch off the mains switch.
 - Keep the key  beneath the speed indicator and the key **IMPULS** pressed simultaneously.
 - Switch on the mains switch and release the keys again.
- The speed indicator shows the machine version and the time indicator shows the set brake step: e.g.:





If the machine version and brake step are not displayed, press the  key under the speed indicator until they are displayed.

The machine version is set by the manufacturer and cannot be changed.

- Set the desired brake step with the keys   beneath the time indicator.
Step 1 = short run-down time, Step 0 = long run-down time.
For run-down times, see chapter "Anhang/Appendix, Rotoren und Zubehör/Rotors and accessories".
- Press the key **STOP** to save the setting.



14 Setting the centrifuging radius

 The centrifuging radius must be entered in centimeters.

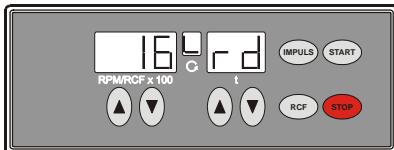
- Switch off the mains switch.
- Keep the key  beneath the speed indicator and the key **IMPULS** pressed simultaneously.
- Switch on the mains switch and release the keys again.
- Press the key  beneath the speed indicator until the following display appears:



The set centrifuging radius is displayed in the speed indicator.

- Set the desired centrifuging radius with the keys   beneath the time indicator.
For centrifuging radius, see chapter "Anhang/Appendix, Rotoren und Zubehör/Rotors and accessories".
- Press the key **STOP** to save the setting.



15 Centrifugation

 When the centrifuge is running, according to EN / IEC 61010-2-020, no persons, dangerous substances or objects may be within the safety margin of 300 mm around the centrifuge.

 If the permissible weight difference is exceeded within the rotor loading, the drive switches off during the run-up time, and error **-3-** is displayed (see chapter "Faults").

The centrifugation run can be interrupted at any time by pressing the key **STOP**.

The time and speed can be changed during the centrifugation run, with the keys  .

If the key  or  is kept pressed, the value changes with increasing speed.





After a centrifugation run, the display flashes until the cover is opened or a key is pressed.

If the symbol "—" (lid closed) and "L" (lid open) flashes alternately in the rotation indicator , operation of the centrifuge can only be continued after opening the lid.

If **rot xx** is displayed, no centrifugation run has taken place because the rotor has been changed, see chapter "Rotor Identification".

- Switch on the mains switch (switch position "I").
- Load the rotor and close the centrifuge cover.

15.1 Centrifugation with preselected time

- Set the desired speed with the keys   beneath the speed indicator.
- Set the desired time with the keys   beneath the time indicator.
- Press the key **[START]**. The rotation indicator  appears while the rotor is turning.







The time is displayed in minutes. The last minute is counted down in seconds.
When the time is displayed in minutes, a point flashes next to the number.

- After expiry of the time or if the centrifugation run is interrupted by pressing the key **[STOP]**, the rotor runs down with the set brake step.

During the centrifugation run, the rotor speed or the resulting RCF value and the remaining time are displayed.

15.2 Continuous operation

- Set the desired speed with the keys   beneath the speed indicator.
- Set the time to zero with the key  beneath the time indicator. "--" is displayed.
- Press the key **[START]**. The rotation indicator  appears while the rotor is turning. The time count starts from 0.





The first minute is counted up in seconds, and then the time is displayed in minutes.
When the time is displayed in minutes, a point flashes next to the number.

- Press the key **[STOP]** to end the centrifugation run. The rotor runs down with the set brake step.

During the centrifugation run, the rotor speed or the resulting RCF value and the expired time are displayed.

15.3 Short-time centrifugation

- Set the desired speed with the keys   beneath the speed indicator.
- Keep the key **[IMPULS]** pressed. The rotation indicator  appears while the rotor is turning. The time count starts from 0.



The first minute is counted up in seconds, and then the time is displayed in minutes.
When the time is displayed in minutes, a point flashes next to the number.

- Release the key **[IMPULS]** again to end the centrifugation run. The rotor runs down with the set brake step.

During the centrifugation run, the rotor speed and the expired time are displayed.

15.4 Display of the relative centrifugal force (RCF)

The relative centrifugal force (RCF) can be displayed during the centrifugation run.



If the relative centrifugal force (RCF) is used, the centrifuging radius must be entered.

- Keep the key **[RCF]** pressed during the centrifugation run.
The relative centrifugal force (RCF) appears in the speed indicator (RCF = displayed value x 100).
- Release the key **[RCF]** again. The speed is displayed.

16 Relative centrifugal force (RCF)

The relative centrifugal force (RCF) is given as a multiple of the acceleration of gravity (g). It is a unit-free value and serves to compare the separation and sedimentation performance.

These values are calculated using the formula below:

$$\text{RCF} = \left(\frac{\text{RPM}}{1000} \right)^2 \times r \times 1,118 \quad \Rightarrow \quad \text{RPM} = \sqrt{\frac{\text{RCF}}{r \times 1,118}} \times 1000$$

RCF = relative centrifugal force

RPM = rotational speed (revolutions per minute)

r = centrifugal radius in mm = distance from the centre of the turning axis to the bottom of the centrifuge.

For more on the centrifugal radius see the chapter "Anhang/Appendix, Rotoren und Zubehör/Rotors and accessories".



The relative centrifugal force (RCF) stands in relation to the revolutions per minute and the centrifugal radius.

17 Centrifugation of materials or mixtures of materials with a density higher than 1.2 kg/dm³

When centrifuging with maximum revolutions per minute the density of the materials or the material mixtures may not exceed 1.2 kg/dm³.

The speed must be reduced for materials or mixtures of materials with a higher density.

The permissible speed can be calculated using the following formula:

$$\text{Reduced speed } (n_{\text{red}}) = \sqrt{\frac{1.2}{\text{Greater density [kg/dm}^3]}} \times \text{maximum speed [RPM]}$$

e.g.: maximum speed RPM 4000, density 1.6 kg/dm³

$$n_{\text{red}} = \sqrt{\frac{1.2 \text{ kg/dm}^3}{1.6 \text{ kg/dm}^3}} \times 4000 \text{ RPM} = 3464 \text{ RPM}$$

In the exceptional case that the maximum loading indicated on the hanger is exceeded, the speed must also be reduced.

The permissible speed can be calculated using the following formula:

$$\text{Reduced speed } (n_{\text{red}}) = \sqrt{\frac{\text{maximum load [g]}}{\text{actual load [g]}}} \times \text{maximum speed [RPM]}$$

e.g.: maximum speed RPM 4000, maximum load 300 g, actual load 350 g

$$n_{\text{red}} = \sqrt{\frac{300 \text{ g}}{350 \text{ g}}} \times 4000 \text{ RPM} = 3703 \text{ RPM}$$

If in doubt you should obtain clarification from the manufacturer.

18 Rotor Identification

After every start of a centrifugation run the rotor utilised is identified.

After a rotor change, the drive switches off and the rotor code (rot xx) is displayed.

- Press the key **START**. The last used centrifuge data will be displayed..



A further operation of the centrifuge is only possible after a single opening of the lid.

If, following a rotor change, the maximum speed of the rotor is less than the set speed, the speed is limited to the maximum speed of the rotor.

19 Emergency release

The lid cannot be opened during power failure. An emergency release has to be executed by hand.



For emergency release disconnect the centrifuge from the mains.

Open the lid only during rotor standstill.

Only the plastic release pin provided may be used for emergency release.

See figure on page 2.

- Switch off the mains switch (switch position "0").
- Look through the window in the lid to be sure that the rotor has come to a standstill.
- Insert the release pin (see scope of supply) horizontally into the hole (Fig. 1, A). Push the unlocking pin in until the handle can be lifted when the pin is pressed down.
- Open the lid.

20 Maintenance and servicing



The device can be contaminated.



Pull the mains plug before cleaning.

Before any other cleaning or decontamination process other than that recommended by the manufacturer is applied, the user has to check with the manufacturer that the planned process does not damage the device.

- Centrifuges, rotors and accessories must not be cleaned in rinsing machines.
- They may only be cleaned by hand and disinfected with liquids.
- The water temperature must be between 20 – 25°C.
- Only detergents/disinfectants may be used which:
 - have a pH between 5 - 8
 - do not contain caustic alkalis, peroxides, chlorine compounds, acids and alkaline solutions
- In order to prevent appearances of corrosion through cleaning agents or disinfectants, the application guide from the manufacturer of the cleaning agent or disinfectant are absolutely to be heeded.

20.1 Centrifuge (housing, lid and centrifuging chamber)

20.1.1 Surface cleaning and care

- Clean the centrifuge housing and the centrifuging chamber regularly, using soap or a mild detergent and a damp cloth if required. For one thing, this services purposes of hygiene, and it also prevents corrosion through adhering impurities.
- Ingredients of suitable detergents: soap, anionic tensides, non-ionic tensides.
- After using detergents, remove the detergent residue by wiping with a damp cloth.
- The surfaces must be dried immediately after cleaning.
- In the event of condensation water formation, dry the centrifugal chamber by wiping out with an absorbent cloth.
- Lightly rub the rubber seal of the centrifuge chamber with talcum powder or a rubber care product after each cleaning.
- The centrifuging chamber is to be checked for damage once a year.



If damage is found which is relevant to safety, the centrifuge may no longer be put into operation. In this case, notify Customer Service.

20.1.2 Surface disinfection

- If infectious materials penetrates into the centrifugal chamber this is to be disinfected immediately.
- Ingredients of suitable disinfectants: ethanol, n-propanol, isopropyl alcohol, glutardialdehyde, quaternary ammonium compounds.
- After using disinfectants, remove the disinfectant residue by wiping with a damp cloth.
- The surfaces must be dried immediately after disinfecting.

20.1.3 Removal of radioactive contaminants

- The agent must be specifically labelled as being an agent for removing radioactive contaminants.
- Ingredients of suitable agents for removing radioactive contaminants: anionic tensides, non-ionic tensides, polyhydrated ethanol.
- After removing the radioactive contaminants, remove the agent residue by wiping with a damp cloth.
- The surfaces must be dried directly after removing the radioactive contaminants.

20.2 Rotors and Attachments

20.2.1 Cleaning and care

- In order to prevent corrosion and material changes, rotors and accessories must be cleaned regularly with soap or a mild detergent and a damp cloth. Cleaning is recommended at least once a week. Contaminants must be removed immediately.
- Ingredients of suitable detergents:
soap, anionic tensides, non-ionic tensides.
- After using detergents, remove detergent residue by rinsing with water (only outside of the centrifuge) or wipe off with a damp cloth.
- The rotors and accessories must be dried directly after cleaning.
- Angle rotors, container and hanger made of aluminium are to be lightly greased after drying using acid-free grease, e.g. vaseline.
- In the case of biosafety systems (for further details of available biosafety systems see chapter "Anhang/Appendix, Rotoren und Zubehör/Rotors and accessories"), the packing rings must be checked and cleaned regularly (weekly). The sealing ring is to be replaced immediately upon indication of crack formation, embrittlement or abrasive wear. In order to prevent the packing ring from twisting when opening and closing the cover, the packing ring must be lightly rubbed with talcum powder or a rubber care product.
- In order to prevent corrosion as a result of moisture between the rotor and the motor shaft, the rotor should be disassembled and cleaned at least once a month, and the motor shaft should be lightly greased.
- The rotors and the accessory parts have to be checked on a monthly basis for wear and corrosion. For swing-out rotors, it is important to check the area of the lifting lugs, for hangers, the grooves and the base should be checked for cracks.



Rotors and attachments may no longer be utilised upon indication of wear and tear or corrosion.

- Check the firm seating of the rotor on a weekly basis.

20.2.2 Disinfection

- If infectious material should get on the rotors or accessories, they must be appropriately disinfected.
- Ingredients of suitable disinfectants:
glutaraldehyde, propanol, ethyl hexanol, anionic tensides, corrosion inhibitors.
- After using disinfectants, remove disinfectant residue by rinsing with water (only outside of the centrifuge) or wipe off with a damp cloth.
- The rotors and accessories must be dried directly after disinfection.

20.2.3 Removal of radioactive contaminants

- The agent must be specifically labelled as being an agent for the removal of radioactive contaminants.
- Ingredients of suitable agents for removing radioactive contaminants:
anionic tensides, non-ionic tensides, polyhydrated ethanol.
- After removing the radioactive contaminants, remove agent residue by rinsing with water (only outside of the centrifuge) or wipe off with a damp cloth.
- The rotors and accessories must be dried directly after removing the radioactive contaminants.

20.2.4 Trunnions

With swing-out rotors the trunnions must be regularly lubricated (Hettich Lubricating Grease No. 4051) in order to ensure consistent swinging out of the hangers.

20.2.5 Rotors and accessories with limited service lives

The use of certain rotors, hangers and accessory parts is limited by time.

These are marked with the maximum permitted number of operating cycles or with an expiration date and the maximum permitted number of operating cycles or just with the expiration date; e.g.:

- "einsetzbar bis Ende: IV. Quartal 2011 / usable until end of: IV. Quarter 2011" or
"einsetzbar bis Ende Monat/Jahr: 10/2011 / usable until end of month/year: 10/2011"
- "Max. Lauf Zyklen / max. cycles: 40000".



For safety reasons, rotors, hangers and accessory parts may no longer be used if either the indicated maximum number of operating cycles or the indicated expiration date has been reached.

20.3 Autoclaving

Swing-out rotors, angle rotors made of aluminium, suspension made of metal, lids with bio-containment as well as stands and reductions can be autoclaved at 121° C / 250°F (20 mins).

Otherwise you must ask the manufacturer.

No statement can be made about the degree of sterility.



The lids of the rotors and containers must be removed prior to autoclaving.

Autoclaving accelerates the ageing process of plastics. In addition, autoclaving may discolour plastics.

We recommend that the packing rings of the bio-safety system be replaced after autoclaving.

20.4 Centrifuge containers

- With leakiness or after the breakage of centrifuging containers broken container parts and leaked centrifugation material are to be completely removed.
- The rubber inserts as well as the plastic sleeves of the rotors are to be replaced after a glass breakage.



Remaining glass splinters cause further glass breakage!

- If this concerns infectious material, a disinfection process is to be executed immediately.

21 Faults

If the fault cannot be eliminated with the help of the fault table, please inform Customer Service.

Please specify the type of centrifuge and the serial number. Both numbers can be found on the name plate of the centrifuge.



Perform a MAINS RESET:

- Switch off the mains switch (switch position "0").
- Wait at least 10 seconds and then switch on the mains switch again (switch position "I").

Fault	Display	Cause of fault	Remedy
No display	---	No voltage Mains input fuses defective.	- Check distribution voltage. - Check mains power input fuse, refer to Chapter "Change mains input fuse". - Mains switch ON.
Tacho error	- 1 -	Failure of speed impulses during operation.	- Due to safety reasons the lid can only be opened after approx. 120 seconds. - After this time has expired perform a MAINS-RESET.
System reset	- 2 -	Power failure during the centrifugation run. (The centrifugation run was not finished.)	- When stationary, open lid and press START key. - Repeat the centrifugation run if necessary.
Balance error	- 3 -	The rotor is unevenly loaded.	- Open lid when rotor is stationary. - Check the loading of the rotor, see chapter "Loading the rotor". - Repeat the centrifugation run.
Communication	- 4 -	Fault in control unit or power unit.	- Perform a MAINS RESET when the rotor has been stationary.
Overload	- 5 -	Motor or motor control defective.	- Perform a MAINS RESET when the rotor has been stationary.
Overvoltage Undervoltage	- 6 - - 8 -	Supply voltage outside tolerance (see Technical Data).	- Perform a MAINS RESET when the rotor has been stationary. - Check supply voltage.
Overspeed	- 7 -	Fault in the power unit.	- Perform a MAINS RESET when the rotor has been stationary
Excess temperature	- 9 -	Excess temperature switch in motor has triggered.	- When rotor is stationary, open lid using emergency unlocking (see Emergency Unlocking chapter). - Allow motor to cool down.
Version error	A number is displayed in the time indicator.	Incorrect machine version set, control unit jumps into Setting menu.	- Set the number 4 using the ▲ ▼ keys underneath the time indicator. - Press the key STOP to save the setting. - Perform a MAINS RESET.
Controller watchdog	- C -	Fault in control unit.	- Perform a MAINS RESET when the rotor has been stationary.
Lid error	- d -	Error in lid locking or lid closure.	- Perform a MAINS RESET when the rotor has been stationary.
Short circuit	- E -	Short circuit in control unit / power unit.	- Perform a MAINS RESET when the rotor has been stationary.
No rotor code	- F -	No rotor recognition at start. No rotor fitted or defective tacho.	- Perform a MAINS RESET when the rotor has been stationary.
New rotor identified	rot...	see section rotor identification.	- Press the key START .

22 Change mains input fuse



Switch off the mains switch and separate the centrifuge from the mains!

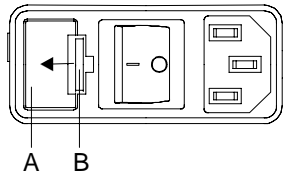

The fuse holder (A) with the mains input fuses is located next to the mains switch.

- Remove the connecting cable from the machine plug socket.
- Press the snap-fit (B) against the fuse holder (A) and remove.
- Exchange defective mains input fuses.



Only use fuses with the rating defined for the type. See the following table.

- Reinsert the fuse holder until the snap-fit clicks shut.
- Reconnect the centrifuge to the mains supply.

Model	Type	Fuse	Order no.
ROTOFIX 32 A	1206	T 3.15 AH/250V	E997
ROTOFIX 32 A	1206-01	T 5 AH/250V	E914

23 Acceptance of the centrifuges for repair

If the centrifuge is returned to the manufacturer for repair, it must be decontaminated and cleaned to protect persons, environment and material.

We reserve the right to accept contaminated centrifuges.

Costs incurred for cleaning and disinfection are to be charged to the customer.

We ask for your understanding in this matter.

24 Disposal

Before disposal, the device must be decontaminated and cleaned to protect people, the environment and property.

When you are disposing of the device, the respective statutory rules must be observed.

Pursuant to guideline 2002/96/EC (WEEE), all devices supplied after August 13, 2005 may not be disposed as part of domestic waste. The device belongs to group 8 (medical devices) and is categorized in the business-to-business field.



The icon of the crossed-out trash can shows that the device may not be disposed as part of domestic waste.

The waste disposal guidelines of the individual EC countries might vary. If necessary, contact your supplier.

Table des matières

1	Usage conforme.....	36
2	Risques résiduels.....	36
3	Données techniques.....	36
4	Consignes de sécurité.....	37
5	Signification des symboles.....	38
6	Composition de la livraison.....	38
7	Déballer la centrifugeuse.....	39
8	Mise en service.....	39
9	Ouvrir et fermer le couvercle.....	39
9.1	Ouvrir le couvercle.....	39
9.2	Fermer le couvercle.....	39
10	Montage et démontage du rotor.....	40
11	Chargement du rotor.....	40
12	Organes de commande et indicateurs.....	41
12.1	Symboles du tableau de commande.....	41
12.2	Touches et possibilités de réglage.....	41
13	Régler le niveau de freinage.....	42
14	Régler le rayon de centrifugation.....	42
15	Centrifugation.....	43
15.1	Centrifugation après présélection du temps.....	43
15.2	Fonctionnement continu.....	43
15.3	Centrifugation de courte durée.....	43
15.4	Affichage de l'accélération centrifuge relative (RCF).....	44
16	Accélération centrifuge relative (RCF).....	44
17	Centrifugation de matières et de mélanges d'une densité supérieure à 1,2 kg/dm ³	44
18	Identification de rotor.....	45
19	Déverrouillage d'urgence.....	45
20	Entretien et maintenance.....	45
20.1	Centrifugeuse (boîtier, couvercle et cuve).....	45
20.1.1	Entretien et nettoyage des surfaces.....	45
20.1.2	Désinfection des surfaces.....	46
20.1.3	Décontamination de substances radioactives.....	46
20.2	Rotors et accessoires.....	46
20.2.1	Nettoyage et entretien.....	46
20.2.2	Désinfection.....	46
20.2.3	Décontamination de substances radioactives.....	46
20.2.4	Goupilles de fixation.....	47
20.2.5	Rotors et accessoires à durée d'utilisation limitée.....	47
20.3	Autoclavage.....	47
20.4	Réservoirs de centrifugation.....	47
21	Défauts.....	48
22	Changer les fusibles d'entrée de secteur.....	49
23	Réparation des centrifugeuses.....	49
24	Élimination des déchets.....	49
25	Anhang / Appendix.....	65
25.1	Rotoren und Zubehör / Rotors and accessories.....	65

1 Usage conforme

La présente machine correspond à un produit de médecine (centrifugeuse de laboratoire) au sens de la directive IVD 98/79/EG. La centrifugeuse sert à séparer les substances ou les substances mélangées ayant une densité supérieure à 1,2 kg/dm³ au max. Cela concerne également les substances et les substances mélangées d'origine humaine. La centrifugeuse est uniquement destinée à cette utilisation. Tout usage autre ou dépassant ce contexte est considéré comme non-conforme. La société Andreas Hettich GmbH & Co. KG décline toute responsabilités pour les dégâts causés par un usage non-conforme.

L'usage conforme comprend également le respect des instructions du mode d'emploi et l'exécution des travaux d'inspection et de maintenance.

2 Risques résiduels

La machine est construite selon l'état de la technique et les règles de sécurité technique reconnues. Une utilisation et un maniement incorrect peuvent entraîner des risques de blessure et de décès pour l'utilisateur ou les tiers ou bien provoquer des dommages sur la machine ou les autres biens matériels. La machine doit uniquement être utilisée dans le cadre de son usage conforme et dans un état de sécurité technique irréprochable.

Il convient de dépanner immédiatement tout dérangement susceptible d'affecter la sécurité.

3 Données techniques

Fabricant	Andreas Hettich GmbH & Co. KG D-78532 Tuttlingen	
Modèle	ROTOFIX 32 A	
Type	1206	1206-01
Tension du réseau (± 10%)	208 – 240 V 1~	100 – 127 V 1~
Fréquence du réseau	50 – 60 Hz	50 – 60 Hz
Charge de connexion	300 VA	300 VA
Consommation de courant	1.4 A	3.0 A
Capacité max.	4 x 100 ml / 32 x 15 ml	
Densité admise	1.2 kg/dm ³	
Vitesse de rotation (RPM)	6000	
Accélération (RCF)	4186	
Energie cinétique	3160 Nm	
Obligation de contrôle (BGR 500)	non	
Conditions ambiantes (EN / IEC 61010-1)	uniquement dans les intérieurs Jusqu'à 2000 m au dessus du niveau de la mer 2°C à 40°C humidité de l'air max. relative 80% pour températures jusqu'à 31°C, décroissant en linéaire jusqu'à 50% de l'humidité relative pour 40°C.	
– Emplacement		
– Hauteur		
– Température ambiante		
– Humidité de l'air		
– Catégorie de surtension (IEC 60364-4-443)	II	
– Degré d'encrassement	2	
Catégorie de protection de l'appareil	I	
Non approprié pour l'usage dans un environnement exposé aux explosions.		
EMV		
– Emission de parasites, Résistance aux interférences	EN / IEC 61326-1, catégorie B	FCC Class B
Niveau du bruit (en fonction du rotor)	≤ 57 dB(A)	
Dimensions		
– Largeur	366 mm	
– Profondeur	430 mm	
– Hauteur	257 mm	
Poids	23 kg	

4 Consignes de sécurité



Aucune demande garantie ne pourra être revendiquée auprès du fabricant si les indications données dans ce mode d'emploi ne sont pas toutes respectées.



- **Veiller à la stabilité de la centrifugeuse.**
- **Avant d'utiliser la centrifugeuse, il est indispensable de vérifier la fixation correcte du rotor.**
- **Durant un processus de centrifugation, aucune personne, matière dangereuse et aucun objet ne doivent se trouver dans une zone de sécurité de 300 mm autour de la centrifugeuse selon EN / IEC 61010-2-020.**
- **Les rotors, balanciers et accessoires qui présentent d'importantes traces de corrosion ou des défauts mécaniques ou dont la durée d'utilisation a expiré ne doivent plus être utilisés.**
- **Suspendre immédiatement l'utilisation de la centrifugeuse si la cuve de centrifugeuse présente des dommages susceptibles de porter atteinte à la sécurité.**
- **Les goupilles de fixation des rotors à amortissement doivent être graissées régulièrement (graisse de lubrification Hettich n° 4051) de manière à assurer le balancement régulier de la suspension.**

- **Il importe de lire et de respecter le mode d'emploi avant la mise en service de la centrifugeuse. Seules les personnes ayant lu et compris le mode d'emploi sont autorisées à manipuler l'appareil.**
- Outre le mode d'emploi et les réglementations contraignantes relatives à la prévention des accidents, il importe également de respecter les règles spécifiques et communément admises en matière de sécurité et de travail. Le mode d'emploi doit être complété des dispositions nationales applicables à la prévention des accidents et à la protection de l'environnement.
- La centrifugeuse a été construite conformément à l'état actuel de la technique et son fonctionnement est sûr. Elle peut cependant présenter des dangers pour l'utilisateur ou des tiers si son utilisation n'est pas confiée à un personnel dûment formé, est inadéquate ou non conforme à sa destination.
- Pendant le fonctionnement, la centrifugeuse ne devra pas être déplacée ou être heurtée.
- En cas de défaillance ou en cas de déverrouillage d'urgence, ne jamais intervenir dans l'appareil lorsque le rotor tourne.
- Afin d'éviter les dommages causés par la condensation en passant d'un local froid à un local chaud, il faut soit réchauffer la centrifugeuse en la laissant pendant au moins 3 heures dans le local chaud avant de la raccorder au secteur, soit la faire fonctionner pendant 30 minutes dans le local froid pour la chauffer.
- Pour cet appareil, vous ne devez utiliser que des rotors et des accessoires homologués par le fabricant (voir chapitre "Anhang/Appendix, Rotoren und Zubehör/Rotors and accessories").
- Le rotor de la centrifugeuse doit uniquement être chargé conformément au chapitre "Chargement du rotor".
- Dans le cas de la centrifugation à la vitesse maximale, la densité des substances et des mélanges de substances ne doit pas excéder 1,2 kg/dm³.
- Il est interdit de procéder à des centrifugations en présence de défauts d'équilibrage.
- La centrifugeuse ne doit pas être exploitée dans un environnement explosif.
- Il est interdit de procéder à des centrifugations :
 - avec des matières inflammables ou explosives,
 - avec des matières susceptibles de réagir chimiquement ou de dégager d'importantes quantités d'énergie.
- En cas de centrifugation de substances dangereuses ou de substances mixtes toxiques, radioactives ou contaminées par des micro-organismes pathogènes, il incombe à l'utilisateur de prendre les mesures ad hoc. Il faut systématiquement utiliser des récipients de centrifugation avec des bouchons spéciaux à vis destinés aux substances dangereuses. Dans le cas des substances des groupes de risques 3 et 4, il faut utiliser un système de sécurité biologique en plus des récipients de centrifugation pouvant être obturés (voir le manuel "Laboratory Biosafety Manual" publié par l'Organisation Mondiale de la Santé). Dans un système de sécurité biologique, un joint biologique (bague d'étanchéité) empêche la fuite de gouttelettes et d'aérosols.

Lorsque la suspension d'un système de sécurité biologique est utilisée sans couvercle, il faut enlever la bague d'étanchéité de la suspension pour éviter de l'endommager pendant le cycle de centrifugation. Les bagues endommagées ne doivent plus être utilisées pour assurer l'étanchéité le système de sécurité biologique.

En l'absence d'un système de sécurité biologique, une centrifugeuse n'est pas étanche du point de vue microbiologique au sens de la norme EN / IEC 61010-2-020.

Pour ce qui concerne les systèmes à sécurité biologique, voir le chapitre "Anhang/Appendix, Rotoren und Zubehör/Rotors and accessories". Dans le doute vous pouvez obtenir les informations auprès du fabricant.

- Il est interdit de centrifuger des matières fortement corrosives pouvant réduire la résistance mécanique des rotors, des supports et des accessoires.
- Les réparations ne peuvent être effectuées que par une personne autorisée à cet effet par le fabricant.
- Utiliser uniquement les pièces de rechange originales et les accessoires d'origine homologués par les Etablissements Andreas Hettich GmbH & Co. KG.
- Les dispositions de sécurité suivantes font foi :
EN / IEC 61010-1 et EN / IEC 61010-2-020 ainsi que les dérogations nationales.
- La sécurité et la fiabilité de la centrifugeuse seront uniquement garanties si :
 - la centrifugeuse est utilisée conformément aux instructions du mode d'emploi,
 - l'installation électrique du site de la centrifugeuse est conforme aux prescriptions EN / IEC,
 - les contrôles prescrits selon BGV A1, BGR 500 sont effectués par un personnel spécialisé averti.

5 Signification des symboles



Symbole sur la machine:

Attention, zone de danger général.

Avant l'utilisation de la centrifugeuse, il est indispensable de lire le mode d'emploi et de respecter les consignes de sécurité !



Symbole dans ce document:

Attention, zone de danger général.

Ce symbole indique des consignes de sécurité et signale des situations pouvant être sources de danger.

Le non-respect de ces instructions peut entraîner des dégâts matériels et personnels.



Symbole sur la machine et dans ce document:

Avertissement de menace biologique pour l'environnement.



Symbole dans ce document:

Ce symbole signale des informations importantes.



Symbole sur la machine et dans ce document:

Symbole pour la collecte séparée des appareils électriques et électroniques, conformément à la directive 2002/96(EG (WEEE). L'appareil fait partie du groupe 8 (appareils de médecine).

Utilisation dans les pays de l'Union Européenne ainsi qu'en Norvège et en Suisse.

6 Composition de la livraison

Les accessoires suivants sont fournis avec la centrifugeuse:

- | | |
|---|--------------------------------------|
| 1 | Câble de connexion |
| 2 | Fusible |
| 1 | Graisse pour tourillon porteur |
| 1 | Clé mâle coudée |
| 1 | Tige de déverrouillage |
| 1 | Fiche de consignes pour le transport |
| 1 | Mode d'emploi |

Le(s) rotor(s) et accessoires correspondant sont livrés selon les spécifications de la commande.

7 Déballer la centrifugeuse

- Soulever le carton et retirer le matériau d'amortissement.

-  Ne pas utiliser la poignée du couvercle pour soulever.
Tenir compte du poids de la centrifugeuse, voir au chapitre "Données techniques".

Avec un nombre suffisant d'aides, soulever la centrifugeuse sur les deux faces et la déposer sur la table de laboratoire.

8 Mise en service

- Selon la norme sur les appareils de laboratoire EN / IEC 61010-2-020, l'installation locale doit être équipée d'un interrupteur d'arrêt d'urgence pour sectionner l'alimentation du secteur en cas de défaut. Cet interrupteur doit être éloigné de la centrifugeuse, de préférence hors de la pièce dans laquelle est la centrifugeuse ou près de la porte.
- Retirer du fond du carter les dispositifs de sécurité pour le transport, voir pour cela la fiche de données "Dispositifs de sécurité pour le transport".
- **Placer la centrifugeuse sur un emplacement approprié de manière à ce qu'elle soit stable et mettre de niveau. Lors de la mise en place, il faut respecter la zone de sécurité exigée de 300mm autour de la centrifugeuse selon EN / IEC 61010-2-020.**

-  **Durant un processus de centrifugation, aucune personne, matière dangereuse et aucun objet ne doivent se trouver dans une zone de sécurité de 300 mm autour de la centrifugeuse selon EN / IEC 61010-2-020.**

- Ne pas placer d'objet devant la grille de ventilation.
Ménager un espace de ventilation de 300 mm autour de la grille.
- Vérifier que la tension de secteur est identique à la mention de la plaque signalétique.
- Raccorder la centrifugeuse à une prise de secteur normalisée au moyen du câble de connexion. Puissance connectée voir chapitre "Données techniques".
- Activer l'interrupteur de secteur. Amener l'interrupteur en position "I".
Les dernières données de centrifuge utilisées s'affichent.
- Ouvrir le capot.

9 Ouvrir et fermer le couvercle

9.1 Ouvrir le couvercle

-  Le capot ne peut être ouvert que lorsque la centrifugeuse est sous tension et que le rotor est à l'arrêt. Dans les autres cas, voir le chapitre, "Déverrouillage d'urgence".

- Faire pivoter la baguette de la poignée du couvercle vers le haut. Le symbole "L" (couvercle ouvert) est allumé dans l'affichage de la rotation .
- Ouvrir le capot.

9.2 Fermer le couvercle

-  Ne pas laisser tomber le couvercle pour le fermer.

- Poser le couvercle dessus et faire pivoter la baguette de la poignée du couvercle vers le bas. Le symbole "—" (couvercle fermé) est allumé dans l'affichage de la rotation .

10 Montage et démontage du rotor

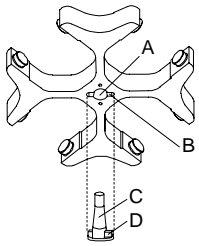

- Nettoyer l'arbre d'entraînement (C) et l'alésage du rotor (A) et enduire ensuite l'arbre d'entraînement d'une pellicule de graisse. Les particules d'impuretés entre l'arbre d'entraînement et le rotor réduisent la stabilité d'assise du rotor et provoquent un fonctionnement irrégulier.
- Enfiler le rotor à la verticale sur l'arbre d'entraînement. Le taquet de l'arbre d'entraînement (D) doit être logé dans la rainure du rotor (B). L'orientation de la rainure est indiquée sur le rotor.
- Serrer l'écrou de fixation du rotor avec la clé de la livraison en tournant dans le sens horloger.
- Vérifier la stabilité d'assise du rotor.
- Démontage du rotor: Desserrer l'écrou de fixation par rotation dans le sens anti-horloger jusqu'à ce que le rotor puisse être détaché par pression. En exerçant une légère pression, détacher le rotor du cône de l'arbre d'entraînement. Dévisser l'écrou de fixation jusqu'à ce que le rotor soit détaché de l'arbre d'entraînement.

11 Chargement du rotor



Des récipients standard de centrifugation en verre sont résistants jusqu' à un ACR de 4000 (DIN 58970, partie 2).

- Vérifier la stabilité d'assise du rotor.
Dans le cas des rotors à balanciers, toutes les positions des rotors doivent être équipées avec les **mêmes** balanciers. Certains balanciers sont désignés avec le numéro de la place du rotor. Ces balanciers doivent exclusivement être installés dans la place de rotor correspondante. Les balanciers désignés par un numéro de set, comme S001/4 par exemple, doivent exclusivement être utilisés dans le set.
- Le chargement des rotors et des balanciers doit être nécessairement symétrique. Les conteneurs de centrifugation doivent être uniformément répartis sur toutes les positions du rotor. Pour les combinaisons possibles, voir le Chapitre "Anhang/Appendix, Rotoren und Zubehör/Rotors and accessories".
Dans le cas des rotors à angle fixe, il faut charger tous les logements possibles du rotor, voir au chapitre "Annexe/Appendix, Rotors et accessoires/Rotors and accessories".

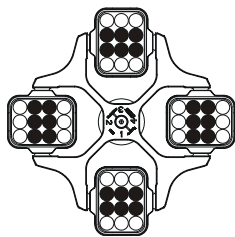

Rotor uniformément chargé

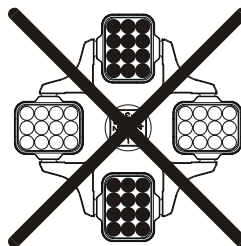

Non autorisé !

Rotor irrégulièrement chargé

- Certains dispositifs de suspension indiquent soit le poids maximum de la charge, soit le poids total maximum comprenant charge et dispositifs. Pour les cas d'exception, voir le chapitre "Centrifugation de matières et de mélanges d'une densité supérieure à 1,2 kg/dm³". L'indication du poids de la charge maximale comprend le poids total de la réduction, châssis, récipient de centrifugation et contenu.
- Dans le cas des récipients à garniture de caoutchouc, les récipients de centrifugation doivent avoir le même nombre de garnitures dans la partie inférieure.
- Les récipients de centrifugation doivent toujours être remplis hors de la centrifugeuse.
- Aucun liquide ne doit parvenir dans le bol de centrifugeuse pendant le remplissage et le déplacement des balanciers.
- La quantité maximale de remplissage indiquée par le fabricant pour les récipients de centrifugation ne doit pas être dépassée.
- La hauteur de remplissage des récipients sera autant que possible égale pour maintenir les différences de poids entre les récipients de centrifugation aussi réduites que possible .

12 Organes de commande et indicateurs

Voir illustration sur la page 2.

Fig. 2: Console des indicateurs et organes de commande

12.1 Symboles du tableau de commande



Affichage de la rotation. L'affichage de la rotation s'allume en tournant dans le sens inverse des aiguilles d'une montre, tant que le rotor tourne.

L'état du couvercle est indiqué grâce aux symboles dans l'affichage de la rotation pendant l'immobilisation du rotor :

Symbole  : couvercle ouvert



Symbole  : couvercle fermé

Les erreurs de commande et les dérangements qui surviennent sont indiqués à l'écran (voir au chapitre "Défauts").

12.2 Touches et possibilités de réglage

RPM/RCF x 100 • Vitesse de rotation





- La valeur numérique pouvant être réglée va de 500 RPM à la vitesse de rotation maximale du rotor. Pour la vitesse de rotation maximale du rotor, voir au chapitre "Annexe/Appendix, Rotors et accessoires/Rotors and accessories". Réglage par pas de 100 (RPM = valeur indiquée x 100). Lorsque vous maintenez enfoncée la touche  ou , la valeur change de plus en plus rapidement.
- Afficher le niveau de freinage et le rayon de centrifugation.

t



- Temps de marche
 - Réglage de 1 à 99 minutes, par pas de 1 minute
 - Fonctionnement continu "--"
- Rayon de centrifugation. Saisie en centimètres. Réglage de 5 à 16 centimètres, par pas de 1 centimètre. Pour le rayon de centrifugation, voir au chapitre "Annexe/Appendix, Rotors et accessoires/Rotors and accessories".
- Niveau de freinage 0 ou 1. Niveau 1 = temps de ralentissement court, niveau 0 = temps de ralentissement long.

Lorsque vous maintenez enfoncée la touche  ou , la valeur change de plus en plus rapidement.



- Démarrer le cycle de centrifugation.



- Terminer le cycle de centrifugation. Le rotor ralentit avec le niveau de freinage présélectionné.
- Sauvegarder le niveau de freinage et le rayon de centrifugation.



- Affichage de l'accélération centrifuge relative (RCF). L'accélération centrifuge relative (RCF) est indiquée tant que la touche  est maintenue enfoncée.



- Centrifugation de courte durée. Le cycle de centrifugation a lieu tant que la touche  est maintenue enfoncée.
- Afficher le niveau de freinage et le rayon de centrifugation.

13 Régler le niveau de freinage

- Couper l'interrupteur de secteur.
- Appuyer simultanément sur la touche ▲ située en dessous de l'affichage de la vitesse de rotation et sur la touche (IMPULS).
- Fermer l'interrupteur de secteur et relâcher les touches.
La version de la machine est indiquée dans l'affichage de la vitesse de rotation et le niveau de freinage réglé dans l'affichage du temps, par ex.:

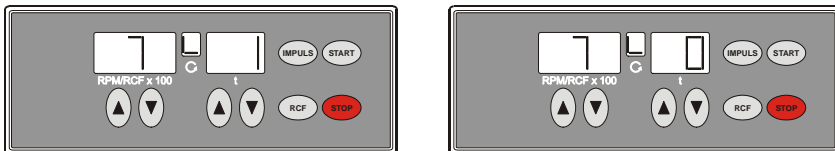

Si la version de la machine et le niveau de freinage ne s'affichent pas, appuyer ensuite sur la touche ▲ située sous l'affichage de la vitesse de rotation jusqu'à ce qu'ils apparaissent.

La version de la machine est réglée à l'usine et ne peut pas être modifiée.

- Régler le niveau de freinage souhaité avec les touches ▲ ▼ situées en dessous de l'affichage du temps. Niveau 1 = temps de ralentissement court, niveau 0 = temps de ralentissement long. Pour les temps de ralentissement, voir au chapitre "Anhang/Appendix, Rotoren und Zubehör/Rotors and accessories".
- Appuyer sur la touche (STOP) pour sauvegarder le réglage.

14 Régler le rayon de centrifugation

 Le rayon de centrifugation doit être saisi en centimètres.

- Couper l'interrupteur de secteur.
- Appuyer simultanément sur la touche ▲ située en dessous de l'affichage de la vitesse de rotation et sur la touche (IMPULS).
- Fermer l'interrupteur de secteur et relâcher les touches.
- Appuyer sur la touche ▲ située en dessous de l'affichage de la vitesse de rotation, jusqu'à ce que l'affichage suivant apparaisse :

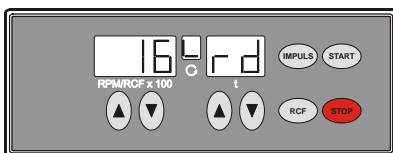

Le rayon de centrifugation est indiqué dans l'affichage de la vitesse de rotation.

- Régler le rayon de centrifugation souhaité avec les touches ▲ ▼ situées en dessous de l'affichage du temps. Pour le rayon de centrifugation, voir au chapitre "Anhang/Appendix, Rotoren und Zubehör/Rotors and accessories".
- Appuyer sur la touche (STOP) pour sauvegarder le réglage.

15 Centrifugation



Durant un processus de centrifugation, aucune personne, matière dangereuse et aucun objet ne doivent se trouver dans une zone de sécurité de 300 mm autour de la centrifugeuse selon EN / IEC 61010-2-020.



Si la différence de poids admissible est dépassée pendant le chargement du rotor, l'entraînement s'arrête pendant le démarrage et l'erreur **-3-** s'affiche (voir au chapitre "Défauts").

Un cycle de centrifugation peut être interrompu à tout moment en appuyant sur la touche **[STOP]**.

Le temps et la vitesse peuvent être modifiés pendant le cycle de centrifugation avec les touches **[▲]** **[▼]**.

Lorsque vous maintenez enfoncée la touche **[▲]** ou **[▼]**, la valeur change de plus en plus rapidement.

L'affichage clignote après un cycle de centrifugation jusqu'à l'ouverture du couvercle ou l'appui d'une touche.

Lorsque le symbole "—" (couvercle fermé) et "L" (couvercle ouvert) clignote à tour de rôle dans l'affichage de la rotation **[C]**, il est alors seulement possible d'exécuter une nouvelle commande de la centrifugeuse après une ouverture du couvercle.

Lorsque **rot xx** s'affiche, c'est qu'aucun cycle de centrifugation n'a eu lieu, car le rotor a été auparavant changé, voir au chapitre "Identification de rotor".

- Fermer l'interrupteur de secteur (position de l'interrupteur "I").
- Charger le rotor et fermer le couvercle de la centrifugeuse.

15.1 Centrifugation après présélection du temps

- Régler la vitesse de rotation souhaitée avec les touches **[▲]** **[▼]** situées en dessous de l'affichage de la vitesse de rotation.
- Régler le temps souhaité avec les touches **[▲]** **[▼]** situées en dessous de l'affichage du temps.
- Appuyer sur la touche **[START]**. La rotation **[C]** est indiquée tant que le rotor fonctionne.



Le temps est indiqué en minutes. La dernière minute est décomptée en secondes.
Lorsque le temps est indiqué en minutes, un point clignote à côté du chiffre.

- Après l'expiration du temps ou l'interruption du cycle de centrifugation en appuyant sur la touche **[STOP]**, le ralentissement du rotor a lieu avec le niveau de freinage réglé.

La vitesse de rotation du rotor ou la valeur RCF en résultant et le temps qui reste s'affichent pendant le cycle de centrifugation.

15.2 Fonctionnement continu

- Régler la vitesse de rotation souhaitée avec les touches **[▲]** **[▼]** situées en dessous de l'affichage de la vitesse de rotation.
- Mettre le temps à zéro avec la touche **[▼]** située en dessous de l'affichage du temps. "--" s'affiche.
- Appuyer sur la touche **[START]**. La rotation **[C]** est indiquée tant que le rotor fonctionne. Le chronométrage commence à 0.



La première minute est comptée en secondes, le temps s'affiche ensuite en minutes.
Lorsque le temps est indiqué en minutes, un point clignote à côté du chiffre.

- Appuyer sur la touche **[STOP]** pour terminer le cycle de centrifugation. Le ralentissement du rotor a lieu avec le niveau de freinage réglé.

La vitesse de rotation du rotor ou la valeur RCF en résultant et le temps écoulé s'affichent pendant le cycle de centrifugation.

15.3 Centrifugation de courte durée

- Régler la vitesse de rotation souhaitée avec les touches **[▲]** **[▼]** situées en dessous de l'affichage de la vitesse de rotation.
- Maintenir enfoncée la touche **[IMPULS]**. La rotation **[C]** est indiquée tant que le rotor fonctionne. Le chronométrage commence à 0.



La première minute est comptée en secondes, le temps s'affiche ensuite en minutes.
Lorsque le temps est indiqué en minutes, un point clignote à côté du chiffre.

- Relâcher la touche **[IMPULS]** pour terminer le cycle de centrifugation. Le ralentissement du rotor a lieu avec le niveau de freinage réglé.

La vitesse de rotation du rotor et le temps écoulé s'affichent pendant le cycle de centrifugation.

15.4 Affichage de l'accélération centrifuge relative (RCF)

L'accélération centrifuge relative (RCF) peut être indiquée pendant le cycle de centrifugation.

 Lorsque vous travaillez avec l'accélération centrifuge relative (RCF), il faut saisir le rayon de centrifugation.

- Maintenir enfoncée la touche **[RCF]** pendant le cycle de centrifugation. L'accélération centrifuge relative (RCF) apparaît dans l'affichage de la vitesse de rotation (RCF = valeur indiquée x 100).
- Relâcher la touche **[RCF]**. La vitesse de rotation est à nouveau indiquée.

16 Accélération centrifuge relative (RCF)

L'accélération centrifuge relative (RCF) est indiqué en tant que multiple de l'accélération gravitationnelle (g). Il s'agit d'une valeur dépourvue d'unité, qui sert à la comparaison entre la puissance de séparation et de sédimentation.

Le calcul s'effectue à l'aide de la formule suivante:

$$RCF = \left(\frac{RPM}{1000} \right)^2 \times r \times 1,118 \quad \Rightarrow \quad RPM = \sqrt{\frac{RCF}{r \times 1,118}} \times 1000$$

RCF = accélération centrifuge relative

RPM = régime

r = rayon de centrifugation en mm = distance qui sépare le centre de l'axe de rotation du fond de la cuve de centrifugation. Rayon de centrifugation voir chapitre "Anhang/Appendix, Rotoren und Zubehör/Rotors and accessories".

 L'accélération centrifuge relative (RCF) est dépendante du régime et du rayon de centrifugation.

17 Centrifugation de matières et de mélanges d'une densité supérieure à 1,2 kg/dm³

Dans le cas de la centrifugation à la vitesse maximale, la densité des substances et des mélanges de substances ne doit pas excéder 1,2 kg/dm³. Réduire la vitesse de rotation pour les matières et mélanges ayant une densité supérieure.

La vitesse de rotation autorisée se calcule de la manière suivante:

$$\text{Vitesse de centrifugation lente (n}_{\text{red}}) = \sqrt{\frac{1,2}{\text{densité supérieure [kg/dm}^3]}} \times \text{Vitesse de rotation maximum [RPM]}$$

Exemple: Vitesse de rotation maximum RPM 4000, densité 1,6 kg/dm³

$$n_{\text{red}} = \sqrt{\frac{1,2 \text{ kg/dm}^3}{1,6 \text{ kg/dm}^3}} \times 4000 \text{ RPM} = 3464 \text{ RPM}$$

Dans le cas exceptionnel de dépassement de la charge maximum indiquée sur la suspension, réduire également la vitesse de rotation.

La vitesse de rotation autorisée se calcule de la manière suivante:

$$\text{Vitesse de centrifugation lente (n}_{\text{red}}) = \sqrt{\frac{\text{Charge maximum [g]}}{\text{Charge réelle [g]}}} \times \text{Vitesse de rotation maximum [RPM]}$$

Exemple: Vitesse de rotation maximum RPM 4000, Charge maximum 300 g, Charge réelle 350 g

$$n_{\text{red}} = \sqrt{\frac{300 \text{ g}}{350 \text{ g}}} \times 4000 \text{ RPM} = 3703 \text{ RPM}$$

En cas d'incertitude, prendre contact avec le fabricant.

18 Identification de rotor

Après démarrage de chaque cycle de centrifugation, la machine exécute une routine d'identification du rotor utilisé. L'entraînement s'arrête après un changement de rotor et le code du rotor (rot xx) s'affiche.

- Appuyer sur la touche **(START)**. Les dernières données de centrifuge utilisées s'affichent.



Toute commande ultérieure de la centrifuge n'est possible qu'après une ouverture du couvercle. Suite à un changement de rotor, si la vitesse maximale de rotation du rotor est inférieure à la vitesse de rotation paramétrée, la vitesse de rotation est limitée à la vitesse maximale de rotation du rotor.

19 Déverrouillage d'urgence

En cas de panne de courant, le couvercle ne peut pas être ouvert. Il est nécessaire d'exécuter un déverrouillage manuel.



Avant d'exécuter le déverrouillage manuel, retirer la fiche de l'alimentation.
Attendre que le rotor est à l'arrêt pour ouvrir le couvercle.
Seule la tige de déverrouillage en plastique fournie peut être utilisée pour un déverrouillage d'urgence.

Voir illustration sur la page 2.

- Couper l'interrupteur de secteur (position de l'interrupteur "0").
- Regarder par la fenêtre située sur le couvercle pour s'assurer que le rotor est immobile.
- Introduire la goupille de déverrouillage horizontalement (voir étendue de la livraison) dans le forage (Fig. 1, A). Enfoncez la tige de déverrouillage jusqu'à ce que vous puissiez faire pivoter la languette de saisie vers le haut lorsque vous poussez la tige vers le bas.
- Ouvrir le capot.

20 Entretien et maintenance



L'appareil est peut-être contaminé.



Retirer la prise de secteur avant de nettoyer.
Avant d'utiliser une procédure de nettoyage ou de décontamination autre que celle recommandée par le fabricant, l'utilisateur vérifiera auprès du fabricant que la procédure prévue n'endommage pas l'appareil.

- Ne pas nettoyer centrifuges, rotors et accessoires dans un lave-vaisselle.
- Seul le nettoyage manuel et une désinfection liquide sont autorisés.
- La température de l'eau doit être située entre 20 et 25°C.
- Utiliser exclusivement des agents de nettoyage ou de désinfection qui :
 - ont un pH de 5 à 8,
 - ne contiennent pas de substances caustiques, de peroxyde, composés chlorés, acides ni alcalins.
- Respecter impérativement les consignes spéciales d'utilisation données par le fabricant des agents de nettoyage et de désinfection, afin de prévenir la corrosion par les agents de nettoyage et de désinfection.

20.1 Centrifugeuse (boîtier, couvercle et cuve)

20.1.1 Entretien et nettoyage des surfaces

- Nettoyer régulièrement le boîtier de la centrifugeuse et le compartiment de centrifugation et les laver en cas de besoin avec du savon ou un détergent doux et un chiffon humide. Ces opérations sont nécessaires pour garantir l'hygiène et pour prévenir la corrosion par la présence durable d'impuretés.
- Substances des nettoyants adéquats :
savon, agents anioniques et non ioniques.
- Après utilisation des nettoyants, enlevez les résidus en essuyant l'appareil avec un chiffon humide.
- Séchez immédiatement les surfaces après nettoyage.
- Sécher le bol avec un chiffon absorbant en cas de dépôt d'eau de condensation dans le bol de la centrifugeuse.
- Frotter légèrement le joint d'étanchéité en caoutchouc du compartiment de centrifugation, après chaque nettoyage, avec de la poudre de talc ou un produit d'entretien pour caoutchouc.
- Vérifiez tous les ans le bon état de la cuve.



N'utilisez plus la centrifugeuse si elle présente des dommages susceptibles de porter atteinte à la sécurité. Auquel cas, contactez le service après-vente.

20.1.2 Désinfection des surfaces

- Le bol de la centrifugeuse doit être nettoyé immédiatement dans le cas où un matériau infectieux a pénétré dans le bol de la centrifugeuse.
- Substances des désinfectants adéquats :
éthanol, n-propanol, isopropanol, glutardialdéhyde, combinaisons ammoniacales quaternaires.
- Après utilisation de désinfectants, enlevez les résidus en essuyant l'appareil avec un chiffon humide.
- Séchez immédiatement les surfaces après désinfection.

20.1.3 Décontamination de substances radioactives

- L'agent employé doit expressément convenir pour une décontamination de substances radioactives.
- Substances des agents adaptés à une décontamination des substances radioactives :
agents anioniques, non ioniques agents, éthanol polyhydre.
- Après décontamination des substances radioactives, enlevez les résidus en essuyant l'appareil avec un chiffon humide.
- Séchez immédiatement les surfaces après décontamination des substances radioactives.

20.2 Rotors et accessoires

20.2.1 Nettoyage et entretien

- Afin de prévenir la corrosion et les modifications des matériaux, il faut laver régulièrement les rotors et les accessoires avec du savon ou un détergent doux et un chiffon humide. Il est vivement recommandé d'effectuer un nettoyage au moins une fois par semaine. Enlevez immédiatement les impuretés.
- Substances des nettoyants adéquats :
savon, agents anioniques et non ioniques.
- Après utilisation de nettoyants, enlevez les résidus en rinçant à l'eau claire (uniquement à l'extérieur de la centrifugeuse) ou en essuyant les surfaces avec un chiffon humide.
- Séchez rotors et accessoires immédiatement après nettoyage.
- Après séchage, les rotors d'angle, les réservoirs et la suspension en aluminium seront enduits d'une pellicule de graisse sans acide, par exemple la vaseline.
- Dans le cas des systèmes de sécurité biologique (Pour ce qui concerne les systèmes à sécurité biologique, voir le chapitre "Anhang/Appendix, Rotoren und Zubehör/Rotors and accessories") il faut contrôler et nettoyer les bagues d'étanchéité régulièrement (toutes les semaines). Changer immédiatement la bague d'étanchéité si elle présente des marques de fissuration, de friabilité et d'usure. Pour éviter de fausser la bague d'étanchéité en ouvrant et en fermant le couvercle, il faut frotter légèrement la bague d'étanchéité avec de la poudre de talc ou un produit d'entretien pour caoutchouc.
- Déposer le rotor au moins une fois par mois, nettoyer et enduire l'arbre d'entraînement d'une pellicule de graisse pour prévenir la corrosion par la présence d'humidité entre le rotor et l'arbre d'entraînement.
- Vérifier une fois par mois l'état d'usure et de corrosion des rotors et des accessoires. Pour les rotors à oscillation, vérifier surtout la zone de portée des tourillons et pour les balanciers, vérifier les rainures et le fond pour détecter les éventuelles fissures.



Les rotors et les accessoires usés et endommagés par la corrosion ne doivent plus être utilisés.

- Vérifier chaque semaine la stabilité de fixation du rotor.

20.2.2 Désinfection

- Si les rotors ou accessoires sont infectés, procédez à une désinfection appropriée.
- Substances des désinfectants adéquats :
glutaraldéhyde, propanol, éthylènehexanol, agents anioniques, inhibiteurs de corrosion.
- Après utilisation de désinfectants, enlevez les résidus en rinçant à l'eau claire (uniquement à l'extérieur de la centrifugeuse) ou en essuyant les surfaces avec un chiffon humide.
- Séchez rotors et accessoires immédiatement après désinfection.

20.2.3 Décontamination de substances radioactives

- L'agent employé doit expressément convenir pour une décontamination de substances radioactives.
- Substances des agents adaptés à une décontamination des substances radioactives :
agents anioniques, agents non ioniques, éthanol polyhydre.
- Après décontamination des substances radioactives, enlevez les résidus en rinçant à l'eau claire (uniquement à l'extérieur de la centrifugeuse) ou en essuyant les surfaces avec un chiffon humide.
- Séchez immédiatement rotors et accessoire après décontamination des substances radioactives.

20.2.4 Goupilles de fixation

Les goupilles de fixation des rotors à amortissement doivent être graissées régulièrement (graisse de lubrification Hettich n° 4051) de manière à assurer le balancement régulier de la suspension.

20.2.5 Rotors et accessoires à durée d'utilisation limitée

L'utilisation de certains rotors, balanciers et accessoires est limitée dans le temps.

Ces limites sont indiquées par le nombre maximum de cycles ou la date limite d'utilisation et le nombre maximum de cycles, ou simplement la date limite d'utilisation, par ex. :

- "einsetzbar bis Ende: IV. Quartal 2011 / usable until end of: IV. trimestre 2011" (utilisation autorisée jusqu'à fin: IV. trimestre 2011) ou
"einsetzbar bis Ende Monat/Jahr: 10/2011 / usable until end of month/year: 10/2011" (utilisation autorisée jusqu'à fin mois/an : 10/2011)
- "max. Laufzyklen / max. cycles: 40000" (nombre ma. de cycles 40000)



Pour des raisons de sécurité, l'utilisation de rotors, balanciers et accessoires n'est plus autorisée dès que le nombre maximum de cycles désigné ou la date limite d'utilisation inscrite sont atteints.

20.3 Autoclavage

Les rotors à oscillation, les rotors angulaires en aluminium, les balanciers en métal, les couvercles avec un joint d'étanchéité biologique, ainsi que les châssis et les réducteurs peuvent être autoclavés à 121 °C / 250 °F (20 min).

En cas de doute, il faut se renseigner auprès du fabricant.

Le degré de stérilité ne peut pas être indiqué.



Avant l'autoclavage, déposer le couvercle des rotors et du récipient.

L'autoclavage provoque l'accélération du vieillissement des plastiques et peut provoquer des décolorations des plastiques.

Nous recommandons le remplacement des bagues d'étanchéité de bio systèmes de sécurité après autoclave.

20.4 Réservoirs de centrifugation

- En cas de fuite ou de rupture de récipients de centrifugation, il faut éliminer tous les morceaux de récipients cassés, les fragments de verre et les substances centrifugées écoulées.
- Les amortisseurs antivibrations ainsi que les caoutchouc intermédiaires des rotors doivent être remplacés après un bris de verre.



Les fragments de verre restants peuvent entraîner d'autres bris de verre !

- S'il s'agit d'un matériau infectieux, exécuter immédiatement une désinfection.

21 Défauts

Si l'erreur ne peut pas être éliminée d'après le tableau des dérangements, il faut alors avertir le service après-vente.

Veillez indiquer le type de centrifuge et le numéro de série. Les deux numéros sont indiqués sur la plaque signalétique de la centrifugeuse.



Effectuer une RÉINITIALISATION DU SECTEUR :

- Couper l'interrupteur de secteur (position de l'interrupteur "0").
- Attendre au moins 10 secondes et refermer ensuite l'interrupteur de secteur (position de l'interrupteur "I").

Erreur	Affichage	Cause	Solution
Pas d'affichage	---	Pas de tension Défaut des fusibles sur l'entrée de secteur.	<ul style="list-style-type: none"> - Vérifier l'alimentation en tension. - Vérifier les fusibles d'entrée du secteur, voir au chapitre "Changer les fusibles d'entrée de secteur". - Interrupteur du secteur sur MARCHÉ
Erreur du compteur de vitesse	- 1 -	Défaillance des impulsions de rotation pendant une opération.	<ul style="list-style-type: none"> - Pour des raisons de sécurité, le couvercle peut seulement être ouvert après env. 120 secondes. - Lorsque cette durée s'est écoulée, effectuer une "RÉINITIALISATION DU SECTEUR".
Reset secteur	- 2 -	Interruption du secteur pendant le cycle de centrifugation. (Le cycle de centrifugation n'est pas terminé.)	<ul style="list-style-type: none"> - Après l'arrêt, ouvrir le couvercle et actionner touche START. - En cas de besoin, répéter le cycle de centrifugation.
Défaut d'équilibrage	- 3 -	Le rotor est chargé de manière non symétrique.	<ul style="list-style-type: none"> - Après arrêt du rotor, ouvrir le couvercle. - Vérifier le chargement du rotor, voir au chapitre "Chargement du rotor". - Répéter le cycle de centrifugation.
Communication	- 4 -	Défaut dans l'unité de commande ou capacité.	<ul style="list-style-type: none"> - Effectuer une RÉINITIALISATION DU SECTEUR après l'immobilisation du rotor.
Surcharge	- 5 -	Moteur ou commande du moteur défectueux.	<ul style="list-style-type: none"> - Effectuer une RÉINITIALISATION DU SECTEUR après l'immobilisation du rotor.
Surtension ou sous-tension	- 6 - - 8 -	Tension du secteur en dehors des tolérances (voir : Caractéristiques techniques).	<ul style="list-style-type: none"> - Effectuer une RÉINITIALISATION DU SECTEUR après l'immobilisation du rotor. - Vérifier tension du secteur.
Survitesse	- 7 -	Défaut dans l'unité de capacité.	<ul style="list-style-type: none"> - Effectuer une RÉINITIALISATION DU SECTEUR après l'immobilisation du rotor.
Surtempérature	- 9 -	Avertisseur de surtempérature dans le moteur a déclenché.	<ul style="list-style-type: none"> - Après arrêt du rotor, ouvrir le couvercle à l'aide du déverrouillage de secours. (Voir chapitre : Déverrouillage de secours). - Laisser refroidir le moteur.
Versions Error	Un chiffre apparaît dans l'affichage du temps.	Une version erronée de la machine a été introduite. Unité de commande saute au menu ajustage.	<ul style="list-style-type: none"> - Régler le chiffre 4 avec les touches ▲ ▼ situées en dessous de l'affichage du temps. - Appuyer sur la touche STOP pour sauvegarder le réglage. - Effectuer une RÉINITIALISATION DU SECTEUR.
Controller-Watchdog	- C -	Défaut dans l'unité de commande.	<ul style="list-style-type: none"> - Effectuer une RÉINITIALISATION DU SECTEUR après l'immobilisation du rotor.
Erreur du verrouillage du couvercle	d	Erreur du verrouillage ou de la fermeture du capot.	<ul style="list-style-type: none"> - Effectuer une RÉINITIALISATION DU SECTEUR après l'immobilisation du rotor.
Court-circuit	- E -	Court-circuit dans l'unité de commande / capacité.	<ul style="list-style-type: none"> - Effectuer une RÉINITIALISATION DU SECTEUR après l'immobilisation du rotor.
Pas de code du rotor	- F -	Pas de reconnaissance du rotor au démarrage. Pas de rotor en service ou compteur de vitesse défectueux.	<ul style="list-style-type: none"> - Effectuer une RÉINITIALISATION DU SECTEUR après l'immobilisation du rotor.
Le nouveau rotor est reconnu	rot...	Voir chapitre détection du rotor	<ul style="list-style-type: none"> - Appuyer sur la touche START.

22 Changer les fusibles d'entrée de secteur



Amener le commutateur principal en position arrêt et sectionner la centrifugeuse du secteur !

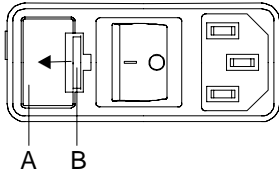

Le porte-fusible (A) avec les fusibles d'entrée de secteur se trouve à côté de l'interrupteur secteur.

- Retirer le câble de raccordement de la prise d'appareil.
- Appuyer la fermeture rapide (B) contre le porte-fusible (A) et extraire celui-ci.
- Remplacer les fusibles d'entrée du réseau défectueux.



N'utilisez que des fusibles avec la valeur nominale, fixée pour le type, voir tableau suivant.

- Remettre en place le porte-fusible et pousser jusqu'à encastrement de la fermeture rapide.
- Rétablir le raccord de la centrifugeuse au secteur.

Modèle	Type	Fusible	N° de commande
ROTOFIX 32 A	1206	T 3.15 AH/250V	E997
ROTOFIX 32 A	1206-01	T 5 AH/250V	E914

23 Réparation des centrifugeuses

Dans le cas où la centrifugeuse est expédiée au fabricant pour réparation, elle doit être décontaminée et nettoyée avant expédition, dans le but d'assurer la protection des personnes, de l'environnement et du matériel.

Nous nous réservons le droit de refuser les centrifugeuses contaminées.

Nous facturons au client les frais de nettoyage et de désinfection.

Vous voudrez bien manifester votre compréhension pour cette réglementation.

24 Élimination des déchets

Avant de mettre l'appareil au rebut, vous devez le décontaminer et le nettoyer pour la protection des personnes, de l'environnement et du matériel.

Les dispositions légales en vigueur doivent être respectées lors de l'élimination de l'appareil.

Conformément à la directive 2002/96/CE (WEEE), tous les appareils livrés après le 13.08.2005 ne doivent plus être jetés avec les déchets ménagers. L'appareil fait partie du groupe 8 (dispositifs médicaux) et est classé dans le domaine "Business-to-Business".



Le symbole de la poubelle barrée d'une croix indique que l'appareil ne doit pas être jeté avec les déchets ménagers.

Les dispositions relatives à l'élimination des déchets des différents pays de l'UE peuvent varier. Veuillez-vous adresser en cas de besoin à votre fournisseur.

Indice

1	Usò previsto	51
2	Rischi residui	51
3	Dati tecnici	51
4	Indicazioni inerenti la sicurezza	52
5	Significato dei simboli	53
6	Contenuto della fornitura	53
7	Disimballo della centrifuga	54
8	Messa in funzione	54
9	Apertura e chiusura del coperchio	54
9.1	Apertura del coperchio	54
9.2	Chiusura del coperchio	54
10	Installazione e disinstallazione del rotore	55
11	Carico del rotore	55
12	Elementi di operazione e visualizzazione	56
12.1	Simboli del quadro comandi	56
12.2	Pulsanti e possibilità di regolazione	56
13	Regolazione del livello di frenatura	57
14	Regolazione del raggio di centrifugazione	57
15	Centrifugazione	58
15.1	Centrifugazione con preselezione del tempo	58
15.2	Funzionamento continuo	58
15.3	Centrifugazione a impulsi	58
15.4	Visualizzazione dell'accelerazione centrifuga relativa (RCF)	59
16	Accelerazione centrifuga relativa (RCF)	59
17	Centrifugazione di sostanze o di miscele di sostanze con densità maggiore di 1,2 kg/dm ³	59
18	Riconoscimento del rotore	59
19	Sblocco di emergenza	60
20	Pulizia e manutenzione	60
20.1	Centrifughe (scatola, coperchio e vano di centrifugazione)	60
20.1.1	Cura e pulizia delle superfici	60
20.1.2	Disinfezione delle superfici	60
20.1.3	Rimuovere contaminazioni radioattive	61
20.2	Rotori ed accessori	61
20.2.1	Pulizia e cura	61
20.2.2	Disinfezione	61
20.2.3	Rimuovere contaminazioni radioattive	61
20.2.4	Perni di trascinamento	61
20.2.5	Rotori ed accessori con limitata durata di impiego	62
20.3	Mantenere in autoclave	62
20.4	Contenitori centrifuga	62
21	Guasti	63
22	Sostituzione fusibili entrata rete	64
23	Accettazione di centrifughe da riparare	64
24	Smaltimento	64
25	Anhang / Appendix	65
25.1	Rotoren und Zubehör / Rotors and accessories	65

1 Uso previsto

La presente macchina è un articolo medicale (centrifuga di laboratorio) ai sensi delle direttive IVD 98/79/CE. La centrifuga separa sostanze e/o miscele di sostanze con una densità max. di 1,2 kg/dm³. Sono comprese anche sostanze e miscele di origine umana. La centrifuga deve essere utilizzata unicamente per questo scopo. Qualsiasi altro tipo di utilizzo è improprio. La ditta Andreas Hettich GmbH & Co. KG non risponde dei danni che ne conseguono.

L'uso previsto comporta anche il rispetto di tutte le avvertenze delle istruzioni d'uso e l'esecuzione dei lavori di ispezione e manutenzione stabiliti.

2 Rischi residui

La macchina è costruita secondo lo stato della tecnica e le regole tecniche di sicurezze riconosciute. L'utilizzo o il trattamento non conformi possono causare pericoli per la vita e la salute dell'operatore o di terzi e anche danni materiali e alla macchina. La macchina deve essere impiegata solo l'uso previsto e solo in perfetto stato di sicurezza.

Eliminare immediatamente i guasti che possono compromettere la sicurezza.

3 Dati tecnici

Costruttore	Andreas Hettich GmbH & Co. KG D-78532 Tuttlingen	
Modello	ROTOFIX 32 A	
Tipo	1206	1206-01
Tensione di rete ($\pm 10\%$)	208 – 240 V 1~	100 – 127 V 1~
Frequenza di rete	50 – 60 Hz	50 – 60 Hz
Potenza assorbita	300 VA	300 VA
Assorbimento di corrente	1.4 A	3.0 A
Capacità max.	4 x 100 ml / 32 x 15 ml	
Densità permessa	1.2 kg/dm ³	
Regime di rotazione (RPM)	6000	
Accelerazione (RCF)	4186	
Energia cinetica	3160 Nm	
Obbligo di collaudo (BGR 500)	no	
Presupposti ambientali (EN / IEC 61010-1)	solo in interni	
– luogo di installazione	fino a 2000 metri sopra il livello del mare	
– altezza	2°C fino a 40°C	
– temperatura ambiente	umidità relativa massima dell'aria 80% per temperature fino a 31°C, con riduzione lineare fino al 50% dell'umidità relativa per una temperatura di 40°C.	
– umidità dell'aria		
– Categoria di sovratensione (IEC 60364-4-443)	II	
– grado di imbrattamento	2	
Classe di protezione	I	
non adatto per l'impiego in ambiente a rischio di esplosione.		
Compatibilità elettromagnetica		
– emissione di radiointerferenze, resistenza alle interferenze	EN / IEC 61326-1, classe B	FCC Class B
Livello di emissione acustica (in funzione del rotore)	≤ 57 dB(A)	
dimensioni		
– larghezza	366 mm	
– profondità	430 mm	
– altezza	257 mm	
Peso	23 kg	

4 Indicazioni inerenti la sicurezza



Se non vengono rispettate tutte le avvertenze riportate in queste istruzioni per il funzionamento, non può essere accettata da parte del costruttore alcuna richiesta di garanzia.



- **La centrifuga deve venire posizionata in modo sicuro.**
- **Prima di utilizzare la centrifuga, è necessario controllare che il rotore sia correttamente in sede.**
- **Durante un'operazione di centrifugazione, in una zona di sicurezza di 300 mm attorno alla centrifuga non deve sostare alcuna persona, materiali pericolosi ed oggetti, in conformità alle norme EN / IEC 61010-2-020.**
- **I rotori, le sospensioni e gli accessori che presentano forti segni di corrosione o danni meccanici, oppure la cui durata d'impiego è scaduta, non devono più essere utilizzati.**
- **Se il vano di centrifugazione presenta danni rilevanti per la sicurezza, la centrifuga non deve essere più messa in funzione.**
- **In rotori oscillanti, i perni di trascinamento devono essere lubrificati regolarmente (Grasso lubrificante Hettich no. d'ord. 4051) per consentire un'oscillazione equilibrata dei ganci.**

- **Prima di mettere in funzione la centrifuga si devono leggere ed osservare le istruzioni per l'uso. L'apparecchio può essere utilizzato solo da persone che abbiano letto e compreso le istruzioni d'uso.**
- Oltre alle istruzioni per l'uso, si devono osservare anche i regolamenti, relativi alla protezione antinfortunistica ed i regolamenti tecnici, riconosciuti in materia di sicurezza del lavoro. Le istruzioni per l'uso vanno completate dalle norme nazionali in vigore nel paese d'impiego, relative alla protezione antinfortunistica ed alla tutela ambientale.
- La centrifuga è costruita in base all'attuale livello tecnologico e le regole di sicurezza conosciute. La centrifuga può essere tuttavia fonte di pericolo per l'operatore o per terzi, se non viene utilizzata da personale appositamente addestrato o se viene utilizzata in modo improprio o non conforme alla destinazione.
- Durante l'esercizio bisogna evitare di muovere la centrifuga o di urtarvi contro.
- In caso di guasto, ovvero del ripristino d'emergenza, non si deve assolutamente toccare il rotore.
- Quando la centrifuga passa da un ambiente freddo in uno caldo, per evitare danni dovuti alla condensa, lasciar riscaldare la centrifuga per almeno 3 ore nell'ambiente caldo prima di collegarla alla rete, oppure portare la centrifuga a temperatura d'esercizio mettendola in funzione per 30 minuti nell'ambiente freddo.
- Devono essere utilizzati esclusivamente i rotori e gli accessori omologati per questa apparecchiatura (vedere capitolo "Anhang/Appendix, Rotoren und Zubehör/Rotors and accessories").
- Il rotore della centrifuga può essere caricato solo in conformità al capitolo " Carico del rotore".
- In caso di centrifugazione con massimo numero di giri, la densità dei materiali o delle miscele di materiali non deve superare il valore di composizione di 1,2 kg/dm³.
- Non è consentito l'uso di centrifughe non bilanciate in modo regolamentare.
- Non è permesso l'impiego della centrifuga in ambiente a pericolo di esplosione.
- E' proibito l'uso di una centrifuga con:
 - materiali infiammabili od esplosivi
 - materiali che possono reagire chimicamente tra loro con forte energia.
- Se vengono centrifugate sostanze pericolose o miscele di sostanze contaminate da micro organismi tossici, radioattivi o patogeni, l'utente dovrà prendere opportuni provvedimenti in materia. Si devono fundamentalmente utilizzare contenitori per centrifugazione con tappi a vite speciali per sostanze pericolose. Con materiali dei gruppi di rischio 3 e 4, oltre ai contenitori per centrifugazione chiudibili si deve impiegare un sistema di sicurezza biologico (vedi manuale "Laboratory Biosafety Manual" dell'Organizzazione mondiale per la salute).
In un sistema di sicurezza biologico una guarnizione biologica (anello di guarnizione) impedisce la fuoriuscita delle goccioline e degli aerosol.
Se la sospensione di un sistema di sicurezza biologico viene usata senza coperchio, la guarnizione ad anello deve essere rimossa dalla sospensione per evitare di danneggiarla durante il ciclo di centrifugazione. Le guarnizioni ad anello danneggiate non possono più essere utilizzate per la chiusura a tenuta del sistema di sicurezza biologico.

Senza l'impiego di un sistema di sicurezza biologico, una centrifuga non è microbiologicamente a tenuta in conformità alla norma EN / IEC 61010-2-020.

Per quanto riguarda i sistemi biologici di sicurezza fornibili, rimandiamo al capitolo "Anhang/Appendix, Rotoren und Zubehör/Rotors and accessories". Nel dubbio chiedere maggiori informazioni al produttore o importatore.

- Non è consentito il funzionamento della centrifuga con sostanze altamente corrosive che possono pregiudicare la resistenza meccanica dei rotori, delle sospensioni e degli accessori.
- Gli interventi di riparazione devono essere effettuati esclusivamente da una persona autorizzata dal costruttore.
- Devono essere impiegati solo ed esclusivamente pezzi di ricambio originali ed accessori autorizzati della ditta Andreas Hettich GmbH & Co. KG.
- Sono di validità le seguenti norme di sicurezza:
EN / IEC 61010-1 e EN / IEC 61010-2-020 come anche le loro nazionali varianti.
- La sicurezza e l'affidabilità della centrifuga sono garantite solo se:
 - la centrifuga funziona in conformità con le istruzioni per l'uso
 - l'installazione elettrica sul luogo di posizionamento della centrifuga risponde ai requisiti previsti dalla EN / IEC
 - i controlli previsti in base a BGV A1, BGR 500 vengono eseguiti da un perito esperto in materia.

5 Significato dei simboli



Simbolo nella macchina:

Attenzione, punto pericoloso generico.

Prima di utilizzare la centrifuga, è assolutamente necessario leggere le istruzioni d'uso e rispettare le avvertenze relative alla sicurezza!



Simbolo in questo documento.

Attenzione, punto pericoloso generico.

Questo simbolo contraddistingue le avvertenze relative alla sicurezza e indica situazioni potenzialmente pericolose.

La mancata osservanza di tali avvertenze può causare danni materiali e personali.



Simbolo nella macchina e in questo documento:

Attenzione: rischio biologico.



Simbolo in questo documento:

Questo simbolo indica argomenti importanti.



Simbolo nella macchina e in questo documento:

Simbolo per la raccolta separata delle apparecchiature elettriche ed elettroniche, in conformità alle direttive 2002/96/CEE (WEEE). L'apparecchiatura appartiene al gruppo 8 (apparecchiature medicali).

Impiego nelle nazioni dell'Unione Europea, in Norvegia ed in Svizzera.

6 Contenuto della fornitura

I seguenti accessori vengono forniti con la centrifuga:

- | | |
|---|--|
| 1 | cavo elettrico |
| 2 | fusibili |
| 1 | grasso per perni portanti |
| 1 | chiave a forcella |
| 1 | chiave di sblocco |
| 1 | istruzioni per la sicurezza durante il trasporto |
| 1 | istruzioni per l'uso |

Rotore/i e i corrispondenti accessori vengono forniti in base alla commessa.

7 Disimballo della centrifuga

- Levare il cartone verso l'alto e togliere l'imbottitura.

-  Non sollevare dall'impugnatura del coperchio.
Considerare il peso della centrifuga, vedere capitolo "Dati tecnici".

Con il numero adeguato di persone, sollevare la centrifuga da entrambi i lati e riporla sul tavolo di laboratorio.

8 Messa in funzione

- Secondo la norma sugli strumenti di laboratorio EN / IEC 61010-2-020 gli impianti domestici devono essere provvisti di apposito sezionatore d'emergenza per l'interruzione della rete in caso di guasto. L'interruttore deve essere posizionato distante dalla centrifuga, preferibilmente al di fuori della stanza in cui è posizionata la centrifuga o vicino all'uscita.
- Togliere la sicura per il trasporto, che si trova sul fondo dell'alloggiamento, vedere foglio avvisi "Sicura per il trasporto".
- **Porre la centrifuga in un posto adatto e livellarla. Per l'installazione deve essere rispettata la zona di sicurezza di 300 mm attorno alla centrifuga, richiesta in conformità alle norme EN / IEC 61010-2-020.**

-  **Durante un'operazione di centrifugazione, in una zona di sicurezza di 300 mm attorno alla centrifuga non deve sostare alcuna persona, materiali pericolosi ed oggetti, in conformità alle norme EN / IEC 61010-2-020.**

- Non posizionare alcun oggetto in prossimità delle griglie di ventilazione. Mantenere un'area di ventilazione di 300 mm, intorno al condotto.
- Verificare se la tensione di rete sia adatta all'indicazione riportata nella targhetta con i dati caratteristici.
- Collegare la centrifuga ad una spina standard di rete tramite il cavo di collegamento. Per la potenza massima assorbita, vedere il capitolo "Dati tecnici".
- Accendere l'interruttore di rete. Posizione di accensione "I". I dati di centrifuga utilizzati per ultimi vengono illustrati.
- Aprire il coperchio.

9 Apertura e chiusura del coperchio

9.1 Apertura del coperchio

-  E' possibile aprire il coperchio solo se la centrifuga è accesa ed il rotore è fermo. Se non dovesse essere possibile, vedi capitolo "Sblocco di emergenza".

- Tirare verso l'alto la barra d'impugnatura sita sul coperchio. Nell'indicazione di rotazione  si accende il simbolo "L" (coperchio aperto).
- Aprire il coperchio.

9.2 Chiusura del coperchio

-  Non chiudere il coperchio sbattendolo.

- Appoggiare il coperchio e abbassare la barra d'impugnatura sita sul coperchio. Nell'indicazione di rotazione  si accende il simbolo "—" (coperchio chiuso).

10 Installazione e disinstallazione del rotore

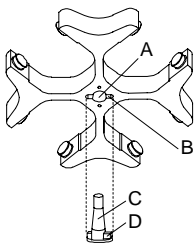

- Pulire l'albero motore (C) ed il foro del rotore (A), successivamente lubrificare leggermente l'albero motore. Particelle di sporco tra l'albero motore ed il rotore impediscono un normale funzionamento del rotore e causano un movimento rumoroso.
- Porre il rotore in senso verticale sull'albero motore. Il meccanismo di trascinarsi dell'albero motore (D) deve trovarsi nella scanalatura del rotore (B). Sul rotore è segnato l'allineamento della scanalatura.
- Stringere il dado di registrazione di tensione del rotore con l'aiuto della chiave inclusa nel cartone, ruotandola in senso orario.
- Verificare che il rotore sia fissato.
- Disinstallare il rotore: svitare il dado di registrazione di tensione, ruotandolo in senso anti-orario fino a che non abbia raggiunto il punto di completo svitamento. Con il punto di svitamento completo, il rotore si può smontare dal cono dell'albero motore. Girare il dado di registrazione di tensione fino a che diventi possibile smontare il rotore dall'albero motore.

11 Carico del rotore



Lo standard dei recipienti di vetro centrifugati sono da caricare fino a RCF 4000 (DIN 58970 capoverso 2).

- Verificare che il rotore sia fissato.
Nel caso di rotori oscillanti, tutti i siti del rotore devono essere muniti di ganci **uguali**. Particolari ganci sono contrassegnati con il numero del sito del rotore. Questi ganci devono essere applicati solo nel relativo sito del rotore.
Ganci contrassegnati con un numero di kit, p.es. S001/4, devono essere utilizzati esclusivamente in kit.
- I rotori ed i ganci devono essere caricati esclusivamente in modo simmetrico. I recipienti di centrifuga devono essere distribuiti uniformemente su tutti i posti del rotore. Per le combinazioni permesse vedere capitolo "Anhang/Appendix, Rotoren und Zubehör/Rotors and accessories".
In caso di rotori angolari devono essere caricati tutti i possibili siti del rotore, vedere il capitolo "Anhang/Appendix, Rotoren und Zubehör/Rotors and accessories".

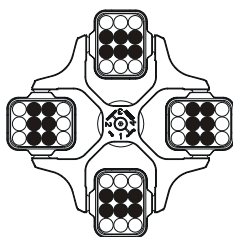

Il rotore è caricato uniformemente

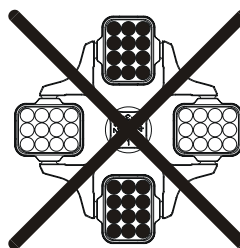

Non ammesso!

Il rotore è caricato in modo non uniforme

- Su certe sospensioni è indicato il peso del carico massimo oppure il peso del carico massimo e il peso massimo della sospensione completamente equipaggiata. Questi pesi non devono essere superati. In casi eccezionali vedere al capitolo "Centrifugazione di sostanze o di miscele di sostanze con densità maggiore di 1,2 kg/dm³". Il peso indicato per il carico massimo comprende il peso completo di riduttore, supporto, provetta da centrifuga e contenuto.
- Nel caso di contenitori con inserimenti in gomma, deve essere sempre mantenuto lo stesso numero di inserimenti in gomma sotto i contenitori di centrifugazione.
- Riempire i recipienti della centrifuga all'esterno della centrifuga stessa.
- Fare attenzione che non giunga alcuna sostanza liquida nella camera di centrifugazione durante il carico ed l'oscillazione dei ganci.
- Il carico massimo dei recipienti della centrifuga non deve essere superiore a quello indicato dalla casa costruttrice.
- Per limitare al massimo le differenze di peso all'interno dei contenitori di centrifugazione, bisogna fare attenzione che siano riempiti tutti in modo uguale.

12 Elementi di operazione e visualizzazione

Vedere illustrazione alla pagina 2.

Fig. 2: Display

12.1 Simboli del quadro comandi



Indicazione di rotazione. L'indicatore di rotazione si illumina ruotando in senso antiorario fino a che il rotore gira.

All'arresto del rotore, l'indicazione di rotazione visualizza mediante simboli lo stato del coperchio:

Simbolo  : coperchio aperto

Simbolo  : coperchio chiuso



Gli errori di operazione e i guasti sono visualizzati sul display (vedere capitolo "Guasti").

12.2 Pulsanti e possibilità di regolazione

RPM/RCF x 100



- Velocità di rotazione

Si può regolare un valore numerico da 500 RPM fino alla velocità massima di rotazione del rotore. Per la velocità massima di rotazione del rotore, vedere capitolo "Appendice/Appendix, Rotori e accessori/Rotors and accessories". Regolabile in intervalli di 100 (RPM = valore visualizzato x 100). Tenendo premuto il pulsante  o  il valore cambia a velocità crescente.

- Visualizzare il livello di frenatura e il raggio di centrifugazione.

t



- Tempo ciclo
 - Regolabile da 1 a 99 minuti, in intervalli di 1 minuto
 - Funzionamento continuo "--"

- Raggio di centrifugazione. Immissione in centimetri. Regolabile da 5 a 16 centimetri, in intervalli di 1 centimetro. Per il raggio di centrifugazione, vedere capitolo "Appendice/Appendix, Rotori e accessori/Rotors and accessories".
- Livelli di frenatura 0 o 1. Livello 1 = tempo di arresto breve, livello 0 = tempo di arresto lungo.

Tenendo premuto il pulsante  o  il valore cambia a velocità crescente.



- Avvio del ciclo di centrifugazione.



- Termine del ciclo di centrifugazione. Il rotore si arresta con il livello di frenatura preselezionato.
- Memorizzare il livello di frenatura e il raggio di centrifugazione.



- Indicazione dell'accelerazione centrifuga relativa (RCF). L'accelerazione centrifuga relativa (RCF) viene visualizzata finché si tiene premuto il pulsante .



- Centrifugazione a impulsi. Il ciclo di centrifugazione ha luogo finché si tiene premuto il pulsante .
- Visualizzare il livello di frenatura e il raggio di centrifugazione.

13 Regolazione del livello di frenatura

- Disinserire l'interruttore di rete.
- Tenere premuti contemporaneamente il pulsante ▲ al di sotto dell'indicazione della velocità di rotazione e il pulsante (IMPULS).
- Inserire l'interruttore di rete e rilasciare i pulsanti.
Nell'indicatore della velocità di rotazione viene visualizzata la versione della macchina e nell'indicatore del tempo il livello di frenatura impostato, per esempio:

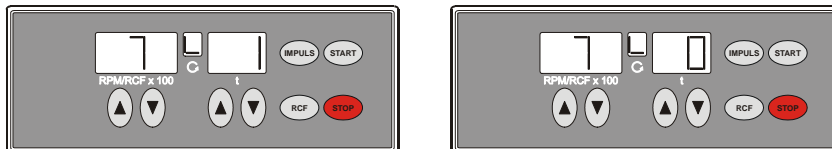

Se la versione della macchina e il livello di frenatura non sono visualizzati, premere il numero di volte necessario a far apparire tali informazioni il tasto ▲ che si trova sotto l'indicazione della velocità di rotazione.

La versione della macchina è impostata dalla casa costruttrice e non può essere cambiata.

- Con i pulsanti ▲ ▼ al di sotto dell'indicazione del tempo, regolare il livello di frenatura desiderato. Livello 1 = tempo di arresto breve, livello 0 = tempo di arresto lungo.
Per i tempi di arresto, vedere capitolo "Anhang/Appendix, Rotoren und Zubehör/Rotors and accessories".
- Premere il pulsante (STOP) per salvare l'impostazione.

14 Regolazione del raggio di centrifugazione

 Il raggio di centrifugazione deve essere immesso in centimetri.

- Disinserire l'interruttore di rete.
- Tenere premuti contemporaneamente il pulsante ▲ al di sotto dell'indicazione della velocità di rotazione e il pulsante (IMPULS).
- Inserire l'interruttore di rete e rilasciare i pulsanti.
- Premere il pulsante ▲ al di sotto dell'indicazione della velocità di rotazione finché appare la seguente visualizzazione:

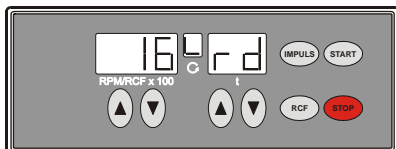

Nell'indicazione della velocità di rotazione viene visualizzato il raggio di centrifugazione impostato.

- Con i pulsanti ▲ ▼ al di sotto dell'indicazione del tempo regolare il raggio di centrifugazione desiderato.
Per il raggio di centrifugazione, vedere capitolo "Anhang/Appendix, Rotoren und Zubehör/Rotors and accessories".
- Premere il pulsante (STOP) per salvare l'impostazione.

15 Centrifugazione



Durante un'operazione di centrifugazione, in una zona di sicurezza di 300 mm attorno alla centrifuga non deve sostare alcuna persona, materiali pericolosi ed oggetti, in conformità alle norme EN / IEC 61010-2-020.



Se la differenza di peso permessa nel carico del rotore è superata, l'azionamento si disinserisce durante l'avvio e viene visualizzato l'errore **-3-** (vedere capitolo "Guasti").

Un ciclo di centrifugazione può essere interrotto in qualsiasi momento premendo il pulsante **[STOP]**.

Il tempo e la velocità di rotazione possono essere modificati durante il ciclo di centrifugazione con i pulsanti **[▲]** **[▼]**.

Tenere premuto il pulsante **[▲]** o **[▼]** per modificare il valore a velocità crescente.

Dopo un ciclo di centrifugazione l'indicazione lampeggia fino all'apertura del coperchio o finché un pulsante viene premuto.

Se nell'indicazione di rotazione **[G]** i simboli **"_"** (coperchio chiuso) e **"L"** (coperchio aperto) lampeggiano alternativamente, è possibile riutilizzare la centrifuga solo dopo aver aperto una volta il coperchio.

Se viene visualizzato **rot xx**, non ha avuto luogo alcun ciclo di centrifugazione a causa di una precedente sostituzione del rotore, vedere capitolo "Riconoscimento del rotore".

- Inserire l'interruttore di rete (posizione interruttore "I").
- Caricare il rotore e chiudere il coperchio della centrifuga.

15.1 Centrifugazione con preselezione del tempo

- Con i pulsanti **[▲]** **[▼]** al di sotto dell'indicazione della velocità di rotazione impostare la velocità di rotazione desiderata.
- Con i pulsanti **[▲]** **[▼]** al di sotto dell'indicazione del tempo regolare il tempo desiderato.
- Premere il pulsante **[START]**. L'indicazione di rotazione **[G]** è accesa finché il rotore gira.



Il tempo è visualizzato in minuti. L'ultimo minuto è contato in secondi.

Se il tempo è visualizzato in minuti, a fianco del numero lampeggia un punto.

- Allo scadere del tempo o in caso di interruzione del ciclo di centrifugazione con il tasto **[STOP]**, il rotore si arresta gradualmente con il livello di frenatura impostato.

Durante il ciclo di centrifugazione sono visualizzati la velocità di rotazione del rotore o il valore RCF risultante e il tempo rimanente.

15.2 Funzionamento continuo

- Con i pulsanti **[▲]** **[▼]** al di sotto dell'indicazione della velocità di rotazione impostare la velocità di rotazione desiderata.
- Con il pulsante **[▼]** al di sotto dell'indicazione del tempo azzerare il tempo. Viene visualizzato **"--"**.
- Premere il pulsante **[START]**. L'indicazione di rotazione **[G]** è accesa finché il rotore gira. Il conteggio del tempo inizia da 0.



Il primo minuto è contato in secondi, quindi il tempo è visualizzato in minuti.

Se il tempo è visualizzato in minuti, a fianco del numero lampeggia un punto.

- Premere il pulsante **[STOP]** per terminare il ciclo di centrifugazione. Il rotore si arresta gradualmente con il livello di frenatura impostato.

Durante il ciclo di centrifugazione sono visualizzati la velocità di rotazione del rotore o il valore RCF risultante e il tempo trascorso.

15.3 Centrifugazione a impulsi

- Con i pulsanti **[▲]** **[▼]** al di sotto dell'indicazione della velocità di rotazione impostare la velocità di rotazione desiderata.
- Tenere premuto il pulsante **[IMPULS]**. L'indicazione di rotazione **[G]** è accesa finché il rotore gira. Il conteggio del tempo inizia da 0.



Il primo minuto è contato in secondi, quindi il tempo è visualizzato in minuti.

Se il tempo è visualizzato in minuti, a fianco del numero lampeggia un punto.

- Rilasciare il pulsante **[IMPULS]** per terminare il ciclo di centrifugazione. Il rotore si arresta gradualmente con il livello di frenatura impostato.

Durante il ciclo di centrifugazione sono visualizzati la velocità di rotazione del rotore e il tempo trascorso.

15.4 Visualizzazione dell'accelerazione centrifuga relativa (RCF)

Durante il ciclo di centrifugazione è possibile visualizzare l'accelerazione centrifuga relativa (RCF).

 Se si utilizza l'accelerazione centrifuga relativa (RCF), è necessario immettere il raggio di centrifugazione.

- Durante il ciclo di centrifugazione tenere premuto il pulsante **[RCF]**.
L'accelerazione centrifuga relativa (RCF) appare nell'indicazione della velocità di rotazione (RCF = valore visualizzato x 100).
- Rilasciare il pulsante **[RCF]**. È nuovamente visualizzata la velocità di rotazione.

16 Accelerazione centrifuga relativa (RCF)

L'accelerazione centrifuga relativa (RCF) è indicata come un multiplo dell'accelerazione terrestre (g). È un valore numerico privo di unità e funge per paragonare le prestazioni di separazione e sedimentazione.

Il calcolo viene eseguito in base alla formula:

$$RCF = \left(\frac{RPM}{1000} \right)^2 \times r \times 1,118 \quad \Rightarrow \quad RPM = \sqrt{\frac{RCF}{r \times 1,118}} \times 1000$$

RCF = accelerazione centrifuga relativa

RPM = numero dei giri

r = raggio di centrifugazione in mm = distanza dal centro dell'asse di rotazione fino al fondo del recipiente di centrifugazione. Raggio di centrifugazione vedi al capitolo "Anhang/Appendix, Rotoren und Zubehör/Rotors and accessories".

 L'accelerazione centrifuga relativa (RCF) dipende dal numero dei giri e dal raggio di centrifugazione.

17 Centrifugazione di sostanze o di miscele di sostanze con densità maggiore di 1,2 kg/dm³

In caso di centrifugazione con massimo numero di giri, la densità dei materiali o delle miscele di materiali non deve superare il valore di composizione di 1,2 kg/dm³.

Con sostanze o miscele di sostanze di densità maggiore, il regime di rotazione deve venire ridotto.

Il numero di giri consentito si calcola con la formula seguente:

$$\text{numero di giri ridotto (n}_{red}\text{)} = \sqrt{\frac{1,2}{\text{densità maggiore [kg/dm}^3\text{]}}} \times \text{regime massimo di rotazione [RPM]}$$

p.es.: regime massimo di rotazione RPM 4000, densità 1,6 kg/dm³

$$n_{red} = \sqrt{\frac{1,2 \text{ kg/dm}^3}{1,6 \text{ kg/dm}^3}} \times 4000 \text{ RPM} = 3464 \text{ RPM}$$

Se in casi eccezionali viene superato il carico massimo indicato sul gancio, il regime di rotazione deve essere ridotto.

Il numero di giri consentito si calcola con la formula seguente:

$$\text{numero di giri ridotto (n}_{red}\text{)} = \sqrt{\frac{\text{carico massimo [g]}}{\text{carico effettivo [g]}}} \times \text{regime massimo di rotazione [RPM]}$$

p.es.: regime massimo di rotazione RPM 4000, carico massimo 350 g, carico effettivo 300 g

$$n_{red} = \sqrt{\frac{300 \text{ g}}{350 \text{ g}}} \times 4000 \text{ RPM} = 3703 \text{ RPM}$$

In caso di dubbio, rivolgersi al costruttore per maggiori informazioni.

18 Riconoscimento del rotore

Con l'inizio di ogni corsa di centrifugazione, avviene il riconoscimento del rotore installato.

Dopo una sostituzione del rotore, l'azionamento si disinserisce e viene visualizzato il codice (rot xx) del rotore.

- Premere il tasto **[START]**. I dati di centrifuga utilizzati per ultimi vengono illustrati.

 L'ulteriore utilizzo della centrifuga è possibile solo dopo avere aperto una volta il coperchio.
Se dopo un cambio del rotore il numero di giri massimo del rotore è inferiore al numero di giri impostato, la velocità viene limitata al numero di giri massimo del rotore.

19 Sblocco di emergenza

In caso di mancanza di corrente non si può aprire il coperchio. Deve essere effettuata manualmente uno sblocco di emergenza.



Per lo sblocco di emergenza, disconnettere la centrifuga dalla rete elettrica.
Aprire il coperchio solo con l'arresto del rotore.
Per lo sblocco di emergenza si può usare solo la chiave di sbocco di plastica in dotazione.

Vedere illustrazione alla pagina 2.

- Disinserire l'interruttore di rete (posizione interruttore "0").
- Guardare attraverso la finestra presente nel coperchio per assicurarsi che il rotore sia fermo.
- Introdurre il perno di sblocco (vedi materiale fornito) orizzontalmente nel foro (Fig. 1, A). Spingere in dentro la spina di sbloccaggio fino a quando, premendo verso il basso la spina, la maniglia si lascia girare verso l'alto.
- Aprire il coperchio.

20 Pulizia e manutenzione



L'apparecchiatura può essere contaminata.



Prima della pulizia, staccare la presa di corrente.
Prima di iniziare un procedimento di pulizia e decontaminazione diverso da quello consigliato dal produttore, l'utilizzatore deve accertarsi presso il produttore che tale procedimento previsto non rechi danno all'apparecchio.

- Centrifughe, rotori e accessori non devono essere lavati in lavastoviglie.
- Si deve eseguire solo una pulizia manuale ed una disinfezione con liquido.
- La temperatura dell'acqua deve essere di 20 – 25°C.
- Devono essere utilizzati solo detersivi o disinfettanti che:
 - abbiano un campo di valori del pH che va da 5 a 8,
 - non contengano alcali caustici, perossidi, composti di cloro, acidi e soluzioni alcaline.
- Seguire attentamente le indicazioni speciali del produttore sull'impiego di detersivi e disinfettanti, al fine di evitare qualsiasi fenomeno di corrosione.

20.1 Centrifughe (scatola, coperchio e vano di centrifugazione)

20.1.1 Cura e pulizia delle superfici

- Pulire regolarmente il corpo della centrifuga e la camera di centrifugazione e impiegare all'occorrenza sapone o un detersivo delicato e un panno umido. Ciò serve da un lato per l'igiene e dall'altro lato per evitare la corrosione causata da impurità incrostate.
- Ingredienti dei detersivi adatti: sapone, tensidi anionici, tensidi non ionici.
- Dopo l'impiego di detersivi, rimuovere i resti del detersivo pulendo di nuovo con un panno umido.
- Le superfici devono essere asciugate subito dopo la pulizia.
- In caso di formazione di acqua di condensa, asciugare la camera di centrifugazione pulendola con un panno assorbente.
- Spalmare sulla guarnizione di gomma della camera di centrifugazione, frizionando leggermente, polvere di talco o una sostanza per la cura della gomma.
- Controllare una volta l'anno se il vano di centrifugazione presenta danneggiamenti.



Se vengono stabiliti danni rilevanti per la sicurezza, la centrifuga non deve essere più messa in funzione. In questo caso si deve contattare il servizio assistenza clienti.

20.1.2 Disinfezione delle superfici

- In presenza di materiale infettivo nella camera di centrifugazione si deve disinfettarla immediatamente.
- Ingredienti dei disinfettanti adatti: etanolo, alcol n proclitico, isopropanolo, glutaraldeide, composti di ammonio quaternario.
- Dopo l'impiego di disinfettanti, rimuovere i resti del disinfettante pulendo di nuovo con un panno umido.
- Le superfici devono essere asciugate subito dopo la disinfezione.

20.1.3 Rimuovere contaminazioni radioattive

- La sostanza deve essere certificata in modo speciale per rimuovere contaminazioni radioattive.
- Ingredienti di sostanze adatte alla rimozione di contaminazioni radioattive: tensidi anionici, tensidi non ionici, etanolo poliidrato.
- Dopo aver rimosso le contaminazioni radioattive, rimuovere i resti della sostanza pulendo di nuovo con un panno umido.
- Le superfici devono essere asciugate, subito dopo la rimozione delle contaminazioni radioattive.

20.2 Rotori ed accessori

20.2.1 Pulizia e cura

- Per evitare che il materiale si corroda o subisca variazione, i rotor e i pezzi accessori devono essere puliti regolarmente con sapone o un detergente delicato e un panno umido. Si consiglia la pulizia almeno una volta la settimana. La sporcizia deve essere subito rimossa.
- Ingredienti dei detergenti adatti: sapone, tensidi anionici, tensidi non ionici.
- Dopo l'impiego di detergenti, rimuovere i resti del detergente, risciacquando con acqua (solo al di fuori della centrifuga) o ripulendo con un panno umido.
- I rotor e gli accessori devono essere asciugati immediatamente dopo la pulizia.
- I rotor ad angolo, i contenitori e i supporti in alluminio devono essere ingrassati leggermente con grasso privo d'acidi come ad esempio vaselina quando sono ben asciutti.
- Nei sistemi di sicurezza biologici (Per quanto riguarda i sistemi biologici di sicurezza fornibili, rimandiamo al capitolo "Anhang/Appendix, Rotoren und Zubehör/Rotors and accessories") gli anelli di guarnizione devono essere controllati e puliti periodicamente (ogni settimana). In presenza di crepe, parti fragili o logorio, l'anello di tenuta deve essere subito sostituito. Per evitare che durante l'apertura e la chiusura del coperchio l'anello di guarnizione si giri, spalmarvi, frizionando leggermente, polvere di talco o una sostanza per la cura della gomma.
- Per evitare la corrosione causata dall'umidità tra il rotore e l'albero motore, si deve provvedere almeno una volta al mese di smontare il rotore, pulirlo e di lubrificare leggermente l'albero motore.
- I rotor e gli elementi accessori devono essere verificati mensilmente per quanto riguarda il loro stato di usura ed i danneggiamenti da corrosione.
Con i motori di smorzamento devono essere verificati soprattutto il settore dei perni di supporto e per i ganci le scanalature, verificare inoltre l'eventuale presenza di incrinature nel fondo.



Rotori ed accessori non devono essere più utilizzati se presentano consumo o corrosione.

- Verificare settimanalmente la posizione del rotore.

20.2.2 Disinfezione

- Se del materiale infetto viene a contatto con i rotor o con gli accessori, allora si deve eseguire una disinfezione adeguata.
- Ingredienti dei disinfettanti adatti: glutaraldeide, propanolo, etilexanolo, tensidi anionici, inibitori di corrosione.
- Dopo l'impiego di disinfettanti, rimuovere i resti del disinfettante, risciacquando con acqua (solo al di fuori della centrifuga) o ripulendo con un panno umido.
- I rotor e gli accessori devono essere asciugati immediatamente dopo la disinfezione.

20.2.3 Rimuovere contaminazioni radioattive

- La sostanza deve essere certificata in special modo per rimuovere contaminazioni radioattive.
- Ingredienti di sostanze adatte alla rimozione di contaminazioni radioattive: tensidi anionici, tensidi non ionici, etanolo poliidrato.
- Dopo la rimozione delle contaminazioni radioattive, rimuovere la sostanza, risciacquando con acqua (solo al di fuori della centrifuga) o ripulendo con un panno umido.
- I rotor e gli accessori devono essere asciugati subito dopo la rimozione delle contaminazioni radioattive.

20.2.4 Perna di trascinamento

In rotor oscillanti, i perni di trascinamento devono essere lubrificati regolarmente (Grasso lubrificante Hettich no. d'ord. 4051) per consentire un'oscillazione equilibrata dei ganci.

20.2.5 Rotori ed accessori con limitata durata di impiego

L'impiego di particolari rotor, ganci ed elementi accessori è limitato nel tempo.

Questi sono contrassegnati con la quantità max. di cicli di funzionamento o dalla data di scadenza ed il numero massimo di cicli di funzionamento o solo con la data di scadenza, p.es.:

- "einsetzbar bis Ende: IV. Quartal 2011 / usable until end of: IV. trimestre 2011" (utilizzabile fino alla fine: IV. trimestre 2011) o
"einsetzbar bis Ende Monat/Jahr: 10/201 / usable until end of month/year: 10/2011" (utilizzabile fino a fine mese/anno: 10/2011)
- "max. Laufzyklen / max. cycles: 40000". (Max. funzionamento cicli)



Per motivi di sicurezza l'impiego dei rotor, dei ganci e degli elementi di accessorio non è più ammesso, quando è raggiunta la quantità massima permessa dei cicli di funzionamento che è sopracontrassegnata o quando è raggiunta la data di scadenza sopracontrassegnata.

20.3 Mantenere in autoclave

I rotor basculanti, i rotor angolari di alluminio, le sospensioni di metallo, i coperchi con chiusura ermetica anti-contaminazione biologica, come pure i telai e le riduzioni possono essere trattati in autoclave a 121° C / 250° F (20 minuti).

In caso di dubbio occorre informarsi presso la casa produttrice.

Non è possibile fare nessuna dichiarazione sul grado di sterilizzazione.



Il coperchio del rotore ed il contenitore devono essere staccati prima di essere riposti in autoclave.

La conservazione in autoclave accelera il processo di invecchiamento del materiale in plastica. Inoltre può causare variazioni di colore nel materiale in plastica.

Dopo il trattamento in autoclave consigliamo di sostituire le guarnizioni ad anello dei sistemi biologici di sicurezza.

20.4 Contenitori centrifuga

- In caso di mancanza di tenuta o dopo la rottura dei contenitori per centrifugazione, rimuovere completamente i frammenti dei contenitori, le schegge di vetro e il centrifugato fuoriuscito.
- Dopo la rottura di parti in vetro, sostituire gli inserti di gomma e i manicotti di plastica dei rotor.



Le schegge di vetro rimaste causano ulteriori rotture!

- Nel caso di materiale infettivo, bisogna provvedere immediatamente ad una disinfezione.

21 Guasti

Se non si riesce a eliminare l'errore seguendo le indicazioni della tabella guasti, informare il servizio assistenza clienti.

Si prega di indicare il tipo di centrifuga e il numero di serie. Entrambi i numeri sono visibili sulla targhetta di modello della centrifuga.

	<p>Esecuzione di un RESET RETE:</p> <ul style="list-style-type: none"> - Disinserire l'interruttore di rete (posizione interruttore "0"). - Attendere almeno 10 secondi quindi reinserire l'interruttore di rete (posizione interruttore "1").
---	--

Guasto	Indicatore	Causa dell'errore	Eliminazione
Nessun indicatore	---	Assenza di tensione Scatto del fusibile di sicurezza per sovracorrente.	<ul style="list-style-type: none"> - Controllare la tensione di alimentazione. - Controllare i fusibili di ingresso di rete, vedere il capitolo "Sostituzione fusibili entrata rete". - Interruttore generale ACCESO.
Errore del tachimetro	- 1 -	Mancanza degli impulsi del numero di giri durante il funzionamento.	<ul style="list-style-type: none"> - Per motivi di sicurezza, il coperchio si apre solo dopo ca. 120 secondi. - Allo scadere di questo periodo, eseguire un RESET RETE.
Reset di rete	- 2 -	Interruzione di rete durante il ciclo di centrifugazione. (Il ciclo di centrifugazione non viene terminato.)	<ul style="list-style-type: none"> - Dopo una fase di inattività aprire il coperchio ed azionare il tasto (START). - All'occorrenza ripetere il ciclo di centrifugazione.
Squilibrio	- 3 -	Il rotore è caricato in modo non uniforme.	<ul style="list-style-type: none"> - Aprire il coperchio dopo una fase di inattività del rotore. - Controllare il caricamento del rotore, vedere il capitolo "Carico del rotore". - Ripetere il ciclo di centrifugazione.
Comunicazione	- 4 -	Errore nel modulo di comando o potenza.	<ul style="list-style-type: none"> - Dopo l'arresto del rotore eseguire un RESET RETE.
Sovraccarico	- 5 -	Motore o comandi del motore difettosi.	<ul style="list-style-type: none"> - Dopo l'arresto del rotore eseguire un RESET RETE.
Sovratensione Sottotensione	- 6 - - 8 -	Tensione di rete oltre le tolleranze (vedi dati tecnici).	<ul style="list-style-type: none"> - Dopo l'arresto del rotore eseguire un RESET RETE - Controllare la tensione di rete.
N° giri eccedente	- 7 -	Errore nel comando.	<ul style="list-style-type: none"> - Dopo l'arresto del rotore eseguire un RESET RETE.
Sovratemperatura	- 9 -	Il termostato di massima nel motore è scattato.	<ul style="list-style-type: none"> - Dopo una fase di inattività del rotore, aprire il coperchio mediante lo sbloccaggio di emergenza (vedi capitolo Sbloccaggio di emergenza). - Far raffreddare il motore.
Errore di versione	Nell'indicatore e del tempo viene indicato un numero.	Impostata una versione errata della macchina, il modulo di comando salta al menu di regolazione.	<ul style="list-style-type: none"> - Con i tasti (▲) (▼) presenti sotto l'indicatore impostare il numero 4. - Premere il pulsante (STOP) per salvare l'impostazione. - Esecuzione di un RESET RETE.
Controller-Watchdog	- C -	Errore nel modulo di comando.	<ul style="list-style-type: none"> - Dopo l'arresto del rotore eseguire un RESET RETE.
Errore nella chiusura del coperchio.	- d -	Errore blocco coperchio, ovvero chiusura coperchio.	<ul style="list-style-type: none"> - Dopo l'arresto del rotore eseguire un RESET RETE.
Corto circuito	- E -	Corto circuito nel modulo di comando / potenza.	<ul style="list-style-type: none"> - Dopo l'arresto del rotore eseguire un RESET RETE.
Nessun codice di rotore	- F -	Nessuna identificazione del rotore all'avvio. Nessun rotore installato o tachimetro difettoso.	<ul style="list-style-type: none"> - Dopo l'arresto del rotore eseguire un RESET RETE.
Identificazione nuovo rotore	rot...	Vedi capitolo identificazione sul rotore	<ul style="list-style-type: none"> - Premere il pulsante (START).

22 Sostituzione fusibili entrata rete



Disattivare l'interruttore di rete e sezionare la centrifuga dalla rete!

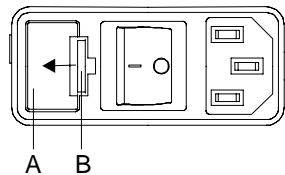

Il portafusibili (A) con i fusibili d'entrata rete si trova accanto all'interruttore di rete.

- Estrarre il cavo di collegamento dalla spina.
- Premere la chiusura a scatto (B) contro il portafusibili (A) ed estrarre quest'ultimo.
- Sostituire i fusibili di rete difettosi.



Utilizzate solo fusibili con valori nominali fissati per il rispettivo tipo, vedere la successiva tabella.

- Inserire di nuovo il portafusibili fino a far scattare la chiusura.
- Collegare di nuovo alla rete la centrifuga.

Modello	Tipo	Fusibile	N° ord.
ROTOFIX 32 A	1206	T 3.15 AH/250V	E997
ROTOFIX 32 A	1206-01	T 5 AH/250V	E914

23 Accettazione di centrifughe da riparare

Nel caso in cui la centrifuga debba essere rispedita al produttore per una eventuale riparazione, prima della spedizione deve essere decontaminata e pulita a fondo a salvaguardia delle persone, dell'ambiente e del materiale.

Ci riserviamo di accettare centrifughe contaminate.

Eventuali costi di pulizia e disinfezione verranno fatturati al cliente.

Contiamo a questo riguardo sulla vostra comprensione.

24 Smaltimento

Prima dello smaltimento, l'apparecchiatura deve essere decontaminata e pulita con lo scopo di proteggere le persone, l'ambiente e il materiale.

Per lo smaltimento dell'apparecchio osservare le rispettive norme di legge.

Ai sensi della direttiva 2002/96/CE (RAEE) tutti gli apparecchi forniti dopo il 13/08/2005 non possono più essere smaltiti con i rifiuti domestici. Questo apparecchio appartiene alla categoria 8 (Dispositivi medicali) ed è classificato nel settore Business-to-Business.











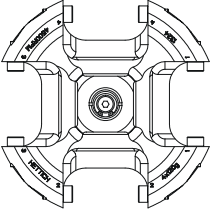
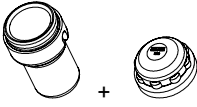





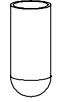

Il simbolo della pattumiera cancellata con una croce indica che l'apparecchio non deve essere smaltito con i rifiuti domestici.

Le norme per lo smaltimento possono essere differenti nei singoli paesi UE. In caso di necessità rivolgersi al proprio rivenditore.

25 Anhang / Appendix

25.1 Rotoren und Zubehör / Rotors and accessories

1324		1390 + 1382								
<p>Ausschwingrotor 4-fach / Swing out rotor 4-times</p>  <p>90°</p>										
		mit Bioabdichtung / with bio-containment 5)								
		0761	0765		1329			1329		1330
										
0526	0534 4)	0535	0500	0507				0519		
										
Kapazität / capacity	ml	100	30		9	15	7,5 - 8,2 15 x 92	9 - 10 16 x 92	10	25
Maße / dimensions	Ø x L mm	44 x 100	44 x 105		14 x 100	17 x 100	15 x 92	16 x 92	15 x 102	24 x 100
Anzahl p. Rotor / number p. rotor		4	4		16	16	16		16	4
Drehzahl / speed	RPM	4000	4000		4000	4000	4000		4000	4000
RZB / RCF		2522	2504		2504	2504	2504		2630	2397
Radius / radius	mm	141	140		140	140	140		147	134
 9 (97%)	sec	27								
 9	sec	30								
Probenerwärmung/Sample temp. rise	K 1)	10								

1) Probenerwärmung bei maximaler Drehzahl und 1 Stunde Laufzeit (nur bei Zentrifuge ohne Kühlung)

4) nicht mit Stopfen zentrifugierbar, Skal. 10µl-300µl, 15ml, 30ml

5) Nach DIN EN 61010, Teil 2 – 020. Die Hinweise für Bio-Sicherheitssysteme in den Kapiteln "Sicherheitshinweise" und "Pflege und Wartung" beachten











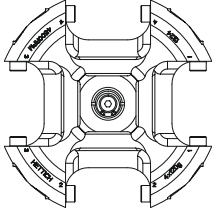
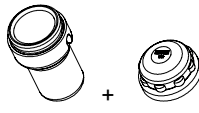

7) Die Einlagen entfernen





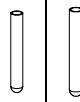
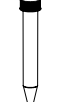
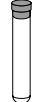
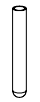

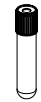



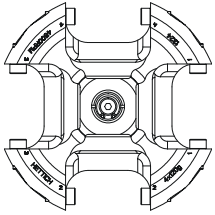
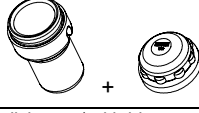

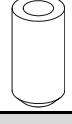
1) Sample temp. rise during maximum speed and 1 hour running time (only with centrifuges without cooling)

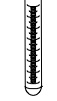
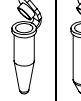
4) can not be centrifugated when plug is attached, Scal. 10µl-300µl, 15ml, 30ml

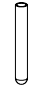
5) in conformity with DIN EN 61010, part 2 – 020. Observe the notes for bio safety systems in chapters "Notes on safety" and "Maintenance and servicing".

7) Remove the inserts

1324		1390 + 1382									
Ausschwingrotor 4-fach / Swing out rotor 4-times  ↙ 90°											
		mit Bioabdichtung / with bio-containment 5)									
		1331	1339	1343	1347	1348					
											
		0521	Rhesus		0509						
											
Kapazität / capacity	ml	50	1	3	4	15	10	8	8,5 - 10	4 - 7	
Maße / dimensions	∅ x L	mm	34 x 100	6 x 45	10 x 60	10 x 88	17 x 120	16 x 80	16 x 81	16 x 100	16 x 75
Anzahl p. Rotor / number p. rotor		4	108	36	4	16	16	16	16	16	
Drehzahl / speed	RPM	4000	4000	4000	4000	4000	4000	4000	4000	4000	
RZB / RCF		2379	2558	2594	2630	2486	2486	2486	2486	2486	
Radius / radius	mm	133	143	145	147	139	139	139	139	139	
 9 (97%)	sec						27				
 9	sec						30				
Probenerwärmung/Sample temp. rise	K ¹⁾						10				









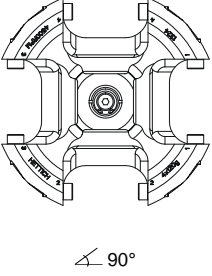
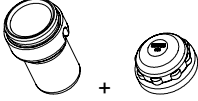

1324		1390 + 1382								
Ausschwingrotor 4-fach / Swing out rotor 4-times  ↙ 90°										
		mit Bioabdichtung / with bio-containment 5)								
		1329	1351	1363	1365	1383				
										
		0518	2078	0536			0501			
										
Kapazität / capacity	ml	15	1,5	2,0	25	30	5	6	7	2,7 - 3
Maße / dimensions	∅ x L	mm	17 x 100	11 x 38	25 x 90	25 x 110	12 x 75	12 x 82	12 x 100	11 x 66
Anzahl p. Rotor / number p. rotor		16	20	4	4	20	20	20	20	20
Drehzahl / speed	RPM	4000	4000	4000	4000	4000	4000	4000	4000	4000
RZB / RCF		2504	2415	2308	2630	2522	2522	2522	2522	2522
Radius / radius	mm	140	135	129	147	141	141	141	141	141
 9 (97%)	sec						27			
 9	sec						30			
Probenerwärmung/Sample temp. rise	K ¹⁾						10			







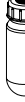



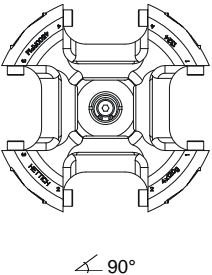
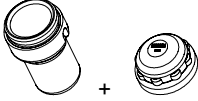



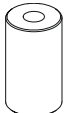

1) Probenerwärmung bei maximaler Drehzahl und 1 Stunde Laufzeit (nur bei Zentrifuge ohne Kühlung)

5) Nach DIN EN 61010, Teil 2 – 020. Die Hinweise für Bio-Sicherheitsysteme in den Kapiteln "Sicherheitshinweise" und "Pflege und Wartung" beachten

1) Sample temp. rise during maximum speed and 1 hour running time (only with centrifuges without cooling)









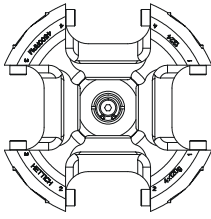

5) in conformity with DIN EN 61010, part 2 – 020. Observe the notes for bio safety systems in chapters "Notes on safety" and "Maintenance and servicing".





1324		1390 + 1382							
Ausschwingrotor 4-fach / Swing out rotor 4-times  90°		 mit Bioabdichtung / with bio-containment 5)							
		1383			1384		1396		
									
Kapazität / capacity	ml	2,6 – 2,9	4,9	4,5 - 5	1,6 -5	4 – 7	50	85	85
Maße / dimensions Ø x L	mm	13 x 65	13 x 90	11 x 92	13 x 75	13 x 100	29 x 115	38 x 106	38 x 106
Anzahl p. Rotor / number p. rotor		20	20	20	20	20	4	4	4
Drehzahl / speed	RPM	4000	4000	4000	4000	4000	4000	4000	4000
RZB / RCF		2522	2522	2522	2522	2522	2630	2576	2576
Radius / radius	mm	141	141	141	141	141	147	144	144
 9 (97%)	sec	27							
 9	sec	30							
Probenerwärmung/Sample temp. rise	K ¹⁾	10							

1324		1390 + 1382													
Ausschwingrotor 4-fach / Swing out rotor 4-times  90°		 mit Bioabdichtung / with bio-containment 5)													
		1459		4416		4417	6311	6318	1356	1457					
															
Kapazität / capacity	ml	4 – 5,5	7,5 – 8,2	50	30	12	50	15	1,1 – 1,4						
Maße / dimensions Ø x L	mm	15 x 75	15 x 92	29 x 107	26 x 95	17 x 100	29 x 115	17 x 120	8 x 66						
Anzahl p. Rotor / number p. rotor		16	16	4	4	4	4	12	28						
Drehzahl / speed	RPM	4000	4000	4000	4000	4000	4000	4000	4000						
RZB / RCF		2540	2540	2594	2415	2630	2630	2630	2540						
Radius / radius	mm	142	142	145	135	147	147	147	142						
 9 (97%)	sec	27													
 9	sec	30													
Probenerwärmung/Sample temp. rise	K ¹⁾	10													

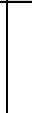
1) Probenerwärmung bei maximaler Drehzahl und 1 Stunde Laufzeit (nur bei Zentrifuge ohne Kühlung)
 5) Nach DIN EN 61010, Teil 2 – 020. Die Hinweise für Bio-Sicherheitssysteme in den Kapiteln "Sicherheitshinweise" und "Pflege und Wartung" beachten

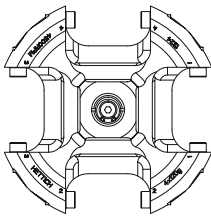



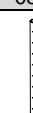



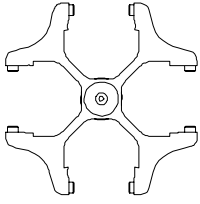

1) Sample temp. rise during maximum speed and 1 hour running time (only with centrifuges without cooling)
 5) in conformity with DIN EN 61010, part 2 – 020. Observe the notes for bio safety systems in chapters "Notes on safety" and "Maintenance and servicing".







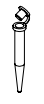
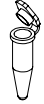
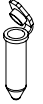

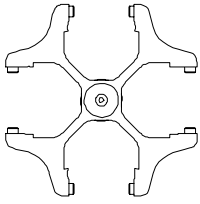

1324		1398								
Ausschwingrotor 4-fach / Swing out rotor 4-times  90°										
		1482								
		2 x 	2 x 							0500
										
Kapazität / capacity	ml	2,6 – 2,9	4 – 4,5	9 – 10	10	12	4 - 7	9	15	
Maße / dimensions	∅ x L	mm	13 x 65	15 x 75	16 x 92	15 x 102	17 x 100	16 x 75	14 x 100	17 x 100
Anzahl p. Rotor / number p. rotor			16	16	16	16	16	16	16	
Drehzahl / speed	RPM		4000	4000	4000	4000	4000	4000	4000	
RZB / RCF			2272	2272	2522	2522	2522	2397	2522	2522
Radius / radius	mm		127	127	141	141	141	134	141	141
9 (97%)	sec	27								
9	sec	30								
Probenerwärmung/Sample temp. rise	K ¹⁾	9								

1324		1398							
Ausschwingrotor 4-fach / Swing out rotor 4-times  90°									
		1483	1484	1484	1482				
			ohne / without E2110						
		0509	Falcon ®	0513	0518				
									
Kapazität / capacity	ml	15	50	50	15				
Maße / dimensions	∅ x L	mm	17 x 120	29 x 115	29 x 115	17 x 100			
Anzahl p. Rotor / number p. rotor			16	4	4	16			
Drehzahl / speed	RPM		4000	4000	4000	4000			
RZB / RCF			2612	2576	2576	2522			
Radius / radius	mm		146	144	144	141			
9 (97%)	sec	27							
9	sec	30							
Probenerwärmung/Sample temp. rise	K ¹⁾	9							

1) Probenerwärmung bei maximaler Drehzahl und 1 Stunde Laufzeit (nur bei Zentrifuge ohne Kühlung)



1) Sample temp. rise during maximum speed and 1 hour running time (only with centrifuges without cooling)



1624		1366									
Ausschwingrotor 4-fach / Swing out rotor 4-times  90°		1308	1345	1346							
					1326	1327	1357	5277			
		0521						Rhe- sus		2078	0536
											
Kapazität / capacity ml	50	45	20	4	3	1	0,4	1,5	2,0		
Maße / dimensions Ø x L mm	34 x 100	31 x 100	21 x 100	12 x 60	10 x 60	6 x 45		11 x 38			
Anzahl p. Rotor / number p. rotor	4	4	8	48	48	120		36			
Drehzahl / speed RPM	4000	4000	4000	4000	4000	4000		4000	4000		
RZB / RCF	2290	2361	2361	1932	1932	1950		1968	1968		
Radius / radius mm	128	132	132	108	108	109		110	110		
 (97%) sec						22					
 1 sec						25					
Probenerwärmung/Sample temp. rise K ¹⁾						10					

1624		1369		1369-92		1370	1372	1369-91	
Ausschwingrotor 4-fach / Swing out rotor 4-times  90°									
					mit Dekantierhilfe / with decanter aid				mit Dekan- tierhilfe / with decanter aid
		0507	0518		0501	0578	0500		
									
Kapazität / capacity ml	15	15	8,5 - 10	6	7	9	5	5	
Maße / dimensions Ø x L mm	17 x 100	17 x 100	16 x 100	12 x 82	12 x 100	14 x 100	12 x 75	12 x 75	
Anzahl p. Rotor / number p. rotor	16	16	16	16	16	20	68	16	
Drehzahl / speed RPM	4000	4000	4000	4000	4000	4000	4000	4000	
RZB / RCF	2308	2308	2308	2308	2308	2308	2164	2057	
Radius / radius mm	129	129	129	129	129	129	121	115	
 (97%) sec						22			
 1 sec						25			
Probenerwärmung/Sample temp. rise K ¹⁾						9			

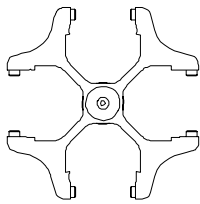
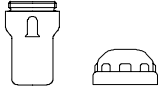
1) Probenerwärmung bei maximaler Drehzahl und 1 Stunde Laufzeit

1) Sample temp. rise during maximum speed and 1 hour running time

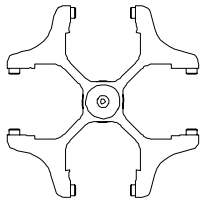
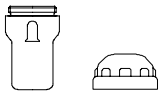
1624		1381 + 1382											
Ausschwingrotor 4-fach / Swing out rotor 4-times  90°		 mit Bioabdichtung / with bio-containment ⁵⁾											
		1329		1330		1331		1339		1343		1347	
		0500		0507		0519		0521		Rhe-sus		0509	
Kapazität / capacity	ml	9	15	7,5 - 8,2	9 - 10	25	50	1	0,4	3	4	15	
Maße / dimensions	Ø x L mm	14 x 100	17 x 100	15 x 92	16 x 92	24 x 100	34 x 100	6 x 45		10 x 60/	10 x 88	17 x 120	
Anzahl p. Rotor / number p. rotor		16	16	16		4	4	108		36		4	
Drehzahl / speed	RPM	4000	4000	4000		4000	4000	4000		4000		4000	
RZB / RCF		2540	2540	2540		2433	2415	2594		2630		2665	
Radius / radius	mm	142	142	142		136	135	145		147		149	
 (97%)	sec	22											
 1	sec	25											
Probenerwärmung/Sample temp. rise	K ¹⁾	10											

1624		1381 + 1382									
Ausschwingrotor 4-fach / Swing out rotor 4-times  90°		 mit Bioabdichtung / with bio-containment ⁵⁾									
		1348				1351		1329		1329	
		2078		0536		7)		0518			
Kapazität / capacity	ml	10	8	4 - 7	8,5 - 10	1,5	2,0	10	15		
Maße / dimensions	Ø x L mm	16 x 80	16 x 81	16 x 75	16 x 100	11 x 38	11 x 38	15 x 102	17 x 100		
Anzahl p. Rotor / number p. rotor		16	16	16	16	20	20	16	16		
Drehzahl / speed	RPM	4000	4000	4000	4000	4000	4000	4000	4000		
RZB / RCF		2522	2522	2522	2522	2451	2451	2665	2540		
Radius / radius	mm	141	141	141	141	137	137	149	142		
 (97%)	sec	22									
 1	sec	25									
Probenerwärmung/Sample temp. rise	K ¹⁾	10									

1) Probenerwärmung bei maximaler Drehzahl und 1 Stunde Laufzeit



5) Nach DIN EN 61010, Teil 2 – 020. Die Hinweise für Bio-Sicherheitssysteme in den Kapiteln "Sicherheitshinweise" und "Pflege und Wartung" beachten





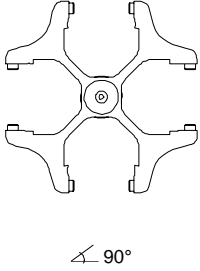
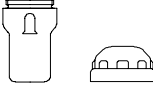

7) Die Einlagen entfernen

1) Sample temp. rise during maximum speed and 1 hour running time

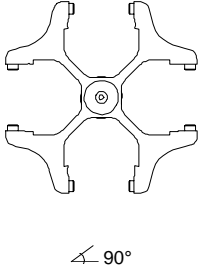
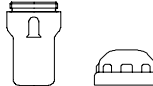
5) in conformity with DIN EN 61010, part 2 – 020. Observe the notes for bio safety systems in chapters "Notes on safety" and "Maintenance and servicing".











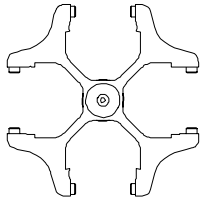
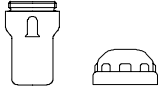

7) Remove the inserts











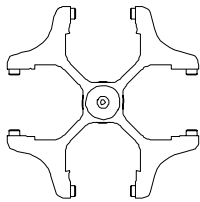



1624		1381 + 1382							
Ausschwingrotor 4-fach / Swing out rotor 4-times  ∠ 90°		 mit Bioabdichtung / with bio-containment 5)							
		1383							
									
		0501							
Kapazität / capacity	ml	5	6	7	4,5 - 5,0	2,7 - 3	2,6 - 2,9	4,9	1,6 - 5,0
Maße / dimensions	∅ x L	mm	12 x 75	12 x 82	12 x 100	11 x 92	11 x 66	13 x 65	13 x 90
Anzahl p. Rotor / number p. rotor			20	20	20	20	20	20	20
Drehzahl / speed	RPM		4000	4000	4000	4000	4000	4000	4000
RZB / RCF			2558	2558	2558	2558	2558	2558	2558
Radius / radius	mm		143	143	143	143	143	143	143
(97%)	sec	22							
1	sec	25							
Probenerwärmung/Sample temp. rise	K ¹⁾	10							

1624		1381 + 1382						SK 13.06		
Ausschwingrotor 4-fach / Swing out rotor 4-times  ∠ 90°		 mit Bioabdichtung / with bio-containment 5)								
		1383		1384	1396		6311	6318	1457	
										
		0513		0547	0549			0519		
Kapazität / capacity	ml	4,5 - 7	50	85	85	12	50	1,1 - 1,4	25	
Maße / dimensions	∅ x L	mm	13 x 100	29 x 115	38 x 106	38 x 106	17 x 100	29 x 115	8 x 66	
Anzahl p. Rotor / number p. rotor			20	4	4	4	4	4	28	
Drehzahl / speed	RPM		4000	4000	4000	4000	4000	4000	4000	
RZB / RCF			2558	2665	2612	2612	2665	2665	2576	
Radius / radius	mm		143	149	146	146	149	149	144	
(97%)	sec	22								
1	sec	25								
Probenerwärmung/Sample temp. rise	K ¹⁾	10								

1) Probenerwärmung bei maximaler Drehzahl und 1 Stunde Laufzeit
 5) Nach DIN EN 61010, Teil 2 – 020. Die Hinweise für Bio-Sicherheitssysteme in den Kapiteln "Sicherheitshinweise" und "Pflege und Wartung" beachten

1) Sample temp. rise during maximum speed and 1 hour running time
 5) in conformity with DIN EN 61010, part 2 – 020. Observe the notes for bio safety systems in chapters "Notes on safety" and "Maintenance and servicing".

1624		1381 + 1382							
Ausschwingrotor 4-fach / Swing out rotor 4-times  		 mit Bioabdichtung / with bio-containment 5)							
		1459		4416	4417	0761	0765	1363	1365
									
		 		0546	0545	0526	0534 4)	0535	
Kapazität / capacity	ml	4 - 5,5	7,5 - 8,2	50	30	100	30	25	30
Maße / dimensions	∅ x L	15 x 75	15 x 92	29 x 107	26 x 95	44 x 100	44 x 105	25 x 90	25 x 110
Anzahl p. Rotor / number p. rotor		16	16	4	4	4	4	4	4
Drehzahl / speed	RPM	4000	4000	4000	4000	4000	4000	4000	4000
RZB / RCF		2576	2576	2630	2451	2558	2540	2343	2665
Radius / radius	mm	144	144	147	137	143	142	131	149
 (97%)	sec	22							
 1	sec	25							
Probenerwärmung/Sample temp. rise	K 1)	10							

1624		1741		1742		1745		1746		1741		1742			
Ausschwingrotor 4-fach / Swing out rotor 4-times  															
		0701		---		---		---		0701		0716		0716	
															
		0500		0518	0507	0519	0545	0521							
Kapazität / capacity	ml	9	15	25	30	50	4,9	1,1 - 1,4	1,6 - 5	4 - 7	4 - 5,5	2,6 - 2,9			
Maße / dimensions	∅ x L	14 x 100	17 x 100	24 x 100	26 x 95	34 x 100	13 x 90	8 x 66	13 x 75	16 x 75	15 x 75	13 x 65			
Anzahl p. Rotor / number p. rotor		40	28	8		4	40	40	28		28				
Drehzahl / speed	RPM	4000	4000	4000		4000	4000	4000	4000		4000				
RZB / RCF		2415	2451	2451		2451	2451	2415	2325		2325				
Radius / radius	mm	135	137	137		137	137	135	130		130				
 (97%)	sec	22													
 1	sec	25													
Probenerwärmung/Sample temp. rise	K 1)	10													

1) Probenerwärmung bei maximaler Drehzahl und 1 Stunde Laufzeit











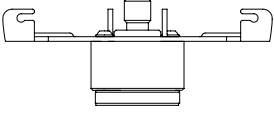



1) Sample temp. rise during maximum speed and 1 hour running time











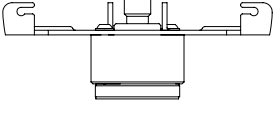



4) nicht mit Stopfen zentrifugierbar, Skal. 10µl-300µl, 15ml, 30ml

4) can not be centrifugated when plug is attached, Scal. 10µl-300µl, 15ml, 30ml

5) Nach DIN EN 61010, Teil 2 – 020. Die Hinweise für Bio-Sicherheitssysteme in den Kapiteln "Sicherheitshinweise" und "Pflege und Wartung" beachten











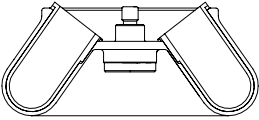

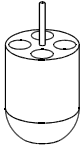

5) in conformity with DIN EN 61010, part 2 – 020. Observe the notes for bio safety systems in chapters "Notes on safety" and "Maintenance and servicing".







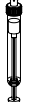
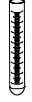



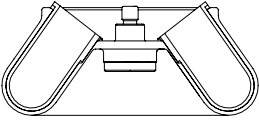

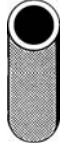

1611	1131					1132			
Ausschwingrotor 8-fach / Swing out rotor 8-times  									
	---	0501				2079			
									
Kapazität / capacity ml	5	6	2,6 - 2,9	2,7 - 3	1,6 - 5,0	10	4,0 - 5,5	4 - 7	
Maße / dimensions Ø x L mm	12/13 x 75	12 x 82	13 x 65	11 x 66	13 x 75	17 x 70	15 x 75	16 x 75	
Anzahl p. Rotor / number p. rotor	8	8	8	8	8	8	8	8	8
Drehzahl / speed RPM	4000	4000	4000	4000	4000	4000	4000	4000	4000
RZB / RCF	1914	1914	1914	1914	1914	1914	1914	1914	1914
Radius / radius mm	107	107	107	107	107	107	107	107	107
 (97%) sec						22			
 1 sec						25			
Probenerwärmung/Sample temp. rise K ¹⁾						6			

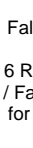
1611	1643				1644				
Ausschwingrotor 8-fach / Swing out rotor 8-times  									
	0578		---		0507			0518	
									
Kapazität / capacity ml	7	4 - 7	10	4,5 - 5	15	7,5 - 8,2	8,5 - 10	15	
Maße / dimensions Ø x L mm	12 x 100	13 x 100	13 x 100	11 x 92	17 x 100	15 x 92	16 x 100	17 x 100	
Anzahl p. Rotor / number p. rotor	8	8	8	8	8	8	8	8	
Drehzahl / speed RPM	4000	4000	4000	4000	4000	4000	4000	4000	
RZB / RCF	2415	2415	2415	2415	2415	2415	2415	2415	
Radius / radius mm	135	135	135	135	135	135	135	135	
 (97%) sec						22			
 1 sec						25			
Probenerwärmung/Sample temp. rise K ¹⁾						9			

1) Probenerwärmung bei maximaler Drehzahl und 1 Stunde Laufzeit









1) Sample temp. rise during maximum speed and 1 hour running time

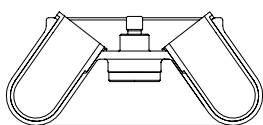
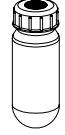







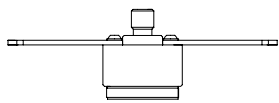

1620A	1449		1448	1451								
Winkelrotor 6-fach / Angle rotor 6-times  												
	2078	0536	---	0507						0518		
												
Kapazität / capacity	ml	1,5	2,0	3	10	15	9 - 10	7,5 - 8,2	8,5 - 10	10	15	
Maße / dimensions	Ø x L	mm	11 x 38	10 x 60	16 x 80	17 x 100	16 x 92	15 x 92	16 x 100	15 x 102	17 x 100	
Anzahl p. Rotor / number p. rotor		24		24	12	6	6	6	6	6		
Drehzahl / speed	RPM	6000		6000	6000	6000	6000	6000	6000	6000		
RZB / RCF	³⁾	4065		4065	3904	3904	3904	3904	3904	3904		
Radius / radius	mm	101		101	97	97	97	97	97	97		
 (97%)	sec						19					
 1	sec						22					
Probenerwärmung/Sample temp. rise	K ¹⁾						5					

1620A	1447	1446	1463		1466	1454	1646			
Winkelrotor 6-fach / Angle rotor 6-times  							Falcon-Set für 6 Rörchchen / Falcon-set for 6 tubes			
	0545	0546	0548	0521	0509	0513	0513			
										
Kapazität / capacity	ml	30	50	75	50	15	50	50		
Maße / dimensions	Ø x L	mm	26 x 95	29 x 107	35 x 105	34 x 100	17 x 120	29 x 115	29 x 115	
Anzahl p. Rotor / number p. rotor		6		6	6	6	6	6		
Drehzahl / speed	RPM	6000		6000	6000	6000	6000	6000		
RZB / RCF	³⁾	3824		4025	4146	4146	3985	3985	3985	
Radius / radius	mm	95		100	103	103	99	99	99	
 (97%)	sec						19			
 1	sec						22			
Probenerwärmung/Sample temp. rise	K ¹⁾						5			

1) Probenerwärmung bei maximaler Drehzahl und 1 Stunde Laufzeit
 3) Zentrifugiergefäße aus Glas nur belastbar bis RZB 4000



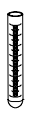



1) Sample temp. rise during maximum speed and 1 hour running time
 3) Centrifuge containers of glass will not stand RCF values exceeding 4000



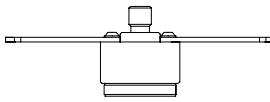
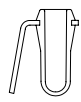



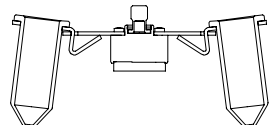
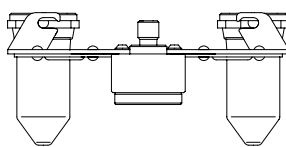

1620A		SK 63.08						
Winkelrotor 6-fach / Angle rotor 6-times  ∠ 35°								
		0547	0549	0501				
								
Kapazität / capacity	ml	85	85	5	6	1,6 - 5	2,6 - 2,9	
Maße / dimensions	∅ x L	mm	38 x 106	38 x 106	12/13 x 75	12 x 82	13 x 75	13 x 65
Anzahl p. Rotor / number p. rotor		6	6	12	12	12	12	
Drehzahl / speed	RPM	6000	6000	6000	6000	6000	6000	
RZB / RCF	³⁾	4186	4186	3783	3783	3783	3783	
Radius / radius	mm	104	104	94	94	94	94	
 (97%)	sec	19						
 1	sec	22						
Probenerwärmung/Sample temp. rise	K ¹⁾	5						

1628	1122			1621					
Ausschwingrotor 12-fach / Swing out rotor 12-times  ∠ 60° mit / with 1122 ∠ 80° mit / with 1621									
		2079			0507			0518	
									
Kapazität / capacity	ml	10	4 - 5,5	4 - 7	15	7,5 - 8,2	8,5 - 10	15	
Maße / dimensions	∅ x L	mm	17 x 70	15 x 75	16 x 75	17 x 100	15 x 92	16 x 100	17 x 100
Anzahl p. Rotor / number p. rotor		12	12	12	12	12	12	12	
Drehzahl / speed	RPM	4000	4000	4000	4000	4000	4000	4000	
RZB / RCF		2254	2254	2254	2683	2683	2683	2683	
Radius / radius	mm	126	126	126	150	150	150	150	
 (97%)	sec	22							
 1	sec	25							
Probenerwärmung/Sample temp. rise	K ¹⁾	12							

1) Probenerwärmung bei maximaler Drehzahl und 1 Stunde Laufzeit
 3) Zentrifugiergefäße aus Glas nur belastbar bis RZB 4000









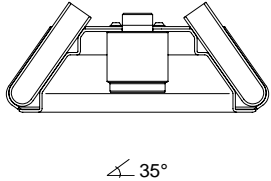
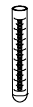

1) Sample temp. rise during maximum speed and 1 hour running time
 3) Centrifuge containers of glass will not stand RCF values exceeding 4000











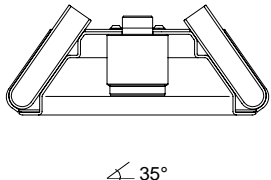

1628		1127							
<p>Ausschwingrotor 12-fach / Swing out rotor 12-times</p>  <p>↙ 55° mit / with 1127</p>									
									
		Kapazität / capacity ml	5	1,6 – 5,0	2,6 – 2,9	2,7 - 3			
		Maße / dimensions Ø x L mm	12 / 13 x 75	13 x 75	13 x 65	11 x 66			
Anzahl p. Rotor / number p. rotor	12	12	12	12					
Drehzahl / speed RPM	4000	4000	4000	4000					
RZB / RCF	2236	2236	2236	2236					
Radius / radius mm	125	125	125	125					
 (97%)	sec	22							
 1	sec	25							
Probenerwärmung/Sample temp. rise K ¹⁾		12							

1617		1619							
<p>Ausschwingrotor 8-fach / Swing out rotor 8-times</p>  <p>↙ 45°</p>		<p>Ausschwingrotor 6-fach / Swing out rotor 6-times</p>  <p>↙ 90°</p>				1681			
						1462-A		1462-A	
						0509	0513	0509	0513
									
Kapazität / capacity ml	15	50	Kapazität / capacity ml	15	50				
Maße / dimensions Ø x L mm	17 x 120	29 x 115	Maße / dimensions Ø x L mm	17 x 120	29 x 115				
Anzahl p. Rotor / number p. rotor	8	8	Anzahl p. Rotor / number p. rotor	6	6				
Drehzahl / speed RPM	4000	4000	Drehzahl / speed RPM	4000	4000				
RZB / RCF	2469	2469	RZB / RCF	2701	2701				
Radius / radius mm	138	138	Radius / radius mm	151	151				
 (97%)	sec	22		 (97%)	sec	22			
 1	sec	25		 1	sec	25			
Probenerwärmung/Sample temp. rise K ¹⁾		11		Probenerwärmung/Sample temp. rise K ¹⁾		10			

1) Probenerwärmung bei maximaler Drehzahl und 1 Stunde Laufzeit











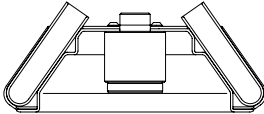

1) Sample temp. rise during maximum speed and 1 hour running time

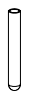









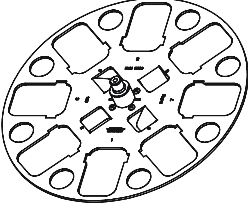





1613										
Winkelrotor 12-fach / Angle rotor 12-times  $\angle 35^\circ$										
		0518	0507	0509						
										
Kapazität / capacity	ml	15	15	15	4 - 7	4,9	4,5 - 5	7,5 - 8,2	9 - 10	
Maße / dimensions	Ø x L	mm	17 x 100	17 x 100	17 x 120	13 x 100	13 x 90	11 x 92	15 x 92	16 x 92
Anzahl p. Rotor / number p. rotor		12	12	6	12	12	12	12	12	
Drehzahl / speed	RPM	6000	6000	6000	6000	6000	6000	6000	6000	
RZB / RCF	³⁾	4146	4146	4146	4146	4146	4146	4146	4146	
Radius / radius	mm	103	103	103	103	103	103	103	103	
 (97%)	sec	13								
 1	sec	15								
Probenerwärmung/Sample temp. rise	K ¹⁾	5								

1613					1054-A					
Winkelrotor 12-fach / Angle rotor 12-times  $\angle 35^\circ$										
						0501				
										
Kapazität / capacity	ml	10	8	8,5 - 10	5	6	1,1 - 1,4	2,7 - 3	2,6 - 2,9	
Maße / dimensions	Ø x L	mm	15 x 102	16 x 125	16 x 100	12/13 x 75	12 x 82	8 x 66	11 x 66	13 x 65
Anzahl p. Rotor / number p. rotor		12	6	12	12	12	12	12	12	
Drehzahl / speed	RPM	6000	6000	6000	6000	6000	6000	6000	6000	
RZB / RCF	³⁾	4146	4146	4146	3300	3300	3300	3300	3300	
Radius / radius	mm	103	103	103	82	82	82	82	82	
 (97%)	sec	13								
 1	sec	15								
Probenerwärmung/Sample temp. rise	K ¹⁾	5								

1) Probenerwärmung bei maximaler Drehzahl und 1 Stunde Laufzeit
 3) Zentrifugiergefäße aus Glas nur belastbar bis RZB 4000











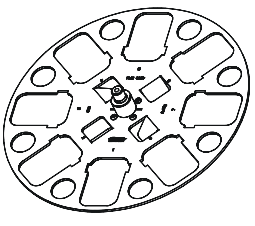

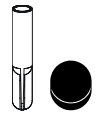
1) Sample temp. rise during maximum speed and 1 hour running time
 3) Centrifuge containers of glass will not stand RCF values exceeding 4000











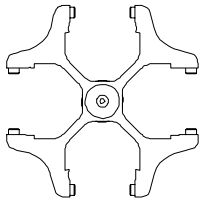
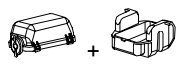

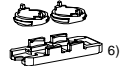
1613		1054-A	1054-A /0701						
Winkelrotor 12-fach / Angle rotor 12-times  				6305	SK 1/89	SK 19/85-4	SK 73/74		
									
Kapazität / capacity	ml	1,6 - 5	4	4	0,8	4 - 5,5	4 - 7	1,5	2
Maße / dimensions	Ø x L	mm	13 x 75	12 x 60	10 x 88	8 x 45	15 x 75	16 x 75	11 x 38
Anzahl p. Rotor / number p. rotor			12	12	12	12	12	12	12
Drehzahl / speed	RPM		6000	6000	6000	6000	6000	6000	6000
RZB / RCF			3300	3260	3502	2576	3663	3663	2737
Radius / radius	mm		82	81	87	64	91	91	68
 (97%)	sec	13							
 1	sec	15							
Probenerwärmung/Sample temp. rise	K ¹⁾	5							

1418		1467				1468			
Winkelrotor 8-fach / Angle rotor 8-times  									
		0716		E2109		E2110			
									
		0507	0518	---	0509	0513	0546	---	
									
Kapazität / capacity	ml	15	15	12	15	50	50	50	
Maße / dimensions	Ø x L	mm	17 x 100	17 x 100	17 x 100	17 x 120	29 x 115	29 x 115	
Anzahl p. Rotor / number p. rotor			32	32	32	32	8	8	
Drehzahl / speed	RPM		4000	4000	4000	4000	4000	4000	
RZB / RCF			2540	2540	2540	2594	2486	2486	
Radius / radius	mm		142	142	142	145	139	139	
 (97%)	sec	36							
 1	sec	43							
Probenerwärmung/Sample temp. rise	K ¹⁾	16							

1) Probenerwärmung bei maximaler Drehzahl und 1 Stunde Laufzeit











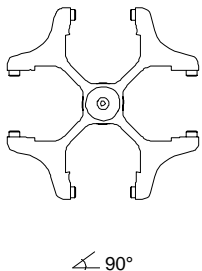
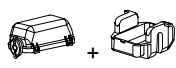

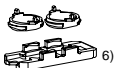
1) Sample temp. rise during maximum speed and 1 hour running time







1418		1467							
Winkelrotor 8-fach / Angle rotor 8-times  ∠ 45°									
		1054-A /0701		1054-A					
									
		0553							
									
Kapazität / capacity	ml	4	5	1,1 – 1,4	2,7 - 3	2,6 – 2,9	1,6 - 5	5	
Maße / dimensions	∅ x L	mm	12 x 60	12 x 75	8 x 66	11 x 66	13 x 65	13 x 75	13 x 75
Anzahl p. Rotor / number p. rotor			32	32	32	32	32	32	
Drehzahl / speed	RPM		4000	4000	4000	4000	4000	4000	
RZB / RCF			2129	2182	2182	2182	2182	2182	
Radius / radius	mm		119	122	122	122	122	122	
 (97%)	sec								36
 1	sec								43
Probenerwärmung/Sample temp. rise	K ¹⁾								16

1624		1661 + 1660								
Ausschwingrotor 4-fach / Swing out rotor 4-times  ∠ 90°										
		1662						1670		
										
		1663	1664	1665	1666	1667	1668	1663	1664	
										
Kapazität / capacity	ml	1	2	4	8	3 x 2	4 x 1	1	2	
Maße / dimensions	∅ / A	mm ²	6,2 / 30	8,7 / 60	12,4 / 120	17,5 / 240	8,7 / 60	6,2 / 30	6,2 / 30	8,7 / 60
Filterkarten / filter cards			1675	1675	1675	1676	1677	1678	1692	1692
Drehzahl / speed	RPM		4000	4000	4000	4000	4000	4000	4000	4000
RZB / RCF			1646	1646	1646	1646	1646	1646	1646	1646
Radius / radius	mm		92	92	92	92	92	92	92	92
 (97%)	sec								22	
 1	sec								25	
Probenerwärmung/Sample temp. rise	K ¹⁾								10	

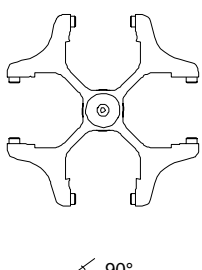
- 1) Probenerwärmung bei maximaler Drehzahl und 1 Stunde Laufzeit
 6) Objektträger nur belastbar bis RZB 1100











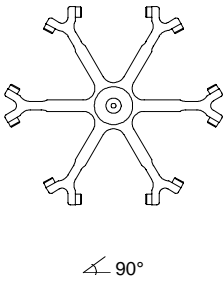
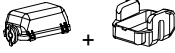

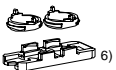
- 1) Sample temp. rise during maximum speed and 1 hour running time
 6) Object slide will not stand RCF values exceeding 1100











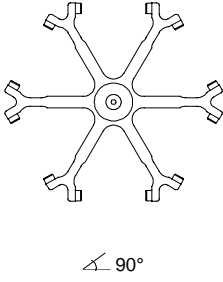

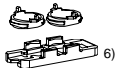

1624		1661 + 1660				1660	1680			
Ausschwingrotor 4-fach / Swing out rotor 4-times 										
										1670
						 nur ohne Deckel / without lid 1661				
		1665	1666	1667	1668			1671	1672	1673
										
Kapazität / capacity	ml	4	8	3 x 2	4 x 1	Objekträger/ object slide	[1] 0,5	[1] 0,5	[1] 0,5	
Maße / dimensions	Ø / A	mm ²	12,4 / 120	17,5 / 240	8,7 / 60	6,2 / 30	26 / 76	6,2 / 30	8,7 / 60	12,4 / 120
Anzahl p. Rotor / number p. rotor		8	8	8	8	24	4	4	4	
Filterkarten / filter cards		1692	1691	1694	1693		[1] 1696	[1] 1697	[1] 1698	
Drehzahl / speed	RPM	4000	4000	4000	4000	4000	4000	4000	4000	
RZB / RCF		1646	1646	1646	1646	1574	1467	1467	1467	
Radius / radius	mm	92	92	92	92	88	82	82	82	
 (97%)	sec	22								
 1	sec	25								
Probenerwärmung/Sample temp. rise	K ¹⁾	10								

1624		1661 + 1660							
Ausschwingrotor 4-fach / Swing out rotor 4-times 									
									
		1471	1475						
									
Kapazität / capacity	ml	1 x 8	2 x 8						
Maße / dimensions	Ø / A	mm ²	17,5 / 240	17,5 / 240					
Anzahl p. Rotor / number p. rotor		4	4						
Filterkarten / filter cards		---	---						
Drehzahl / speed	RPM	4000	4000						
RZB / RCF		1556	1556						
Radius / radius	mm	87	87						
 (97%)	sec	22							
 1	sec	25							
Probenerwärmung/Sample temp. rise	K ¹⁾	10							

1) Probenerwärmung bei maximaler Drehzahl und 1 Stunde Laufzeit
 6) Objekträger nur belastbar bis RZB 1100
 [1] Einschritt-Methode











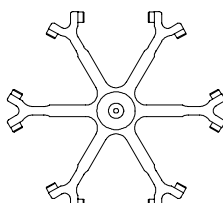

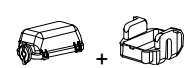

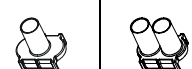
1) Sample temp. rise during maximum speed and 1 hour running time
 6) Object slide will not stand RCF values exceeding 1100
 [1] One-step method

1626		1661 + 1660								
Ausschwingrotor 6-fach / Swing out rotor 6-times  ∠ 90°										
		1662						1670		
										
		1663	1664	1665	1666	1667	1668	1663	1664	
										
Kapazität / capacity	ml	1	2	4	8	3 x 2	4 x 1	1	2	
Maße / dimensions	∅ / A	mm ²	6,2 / 30	8,7 / 60	12,4 / 120	17,5 / 240	8,7 / 60	6,2 / 30	6,2 / 30	8,7 / 60
Anzahl p. Rotor / number p. rotor		6	6	6	6	6	6	12	12	
Filterkarten / filter cards		1675	1675	1675	1676	1677	1678	1692	1692	
Drehzahl / speed	RPM	4000	4000	4000	4000	4000	4000	4000	4000	
RZB / RCF		2039	2039	2039	2039	2039	2039	2039	2039	
Radius / radius	mm	114	114	114	114	114	114	114	114	
 (97%)	sec	22								
 1	sec	25								
Probenerwärmung/Sample temp. rise	K ¹⁾	8								

1626		1661 + 1660				1660	1680			
Ausschwingrotor 6-fach / Swing out rotor 6-times  ∠ 90°										
		1670					1285	1662		
							 nur ohne Deckel / without lid 1661			
		1665	1666	1667	1668		1671	1672	1673	
										
Kapazität / capacity	ml	4	8	3 x 2	4 x 1	Objektträger/ object slide	[1] 0,5	[1] 0,5	[1] 0,5	
Maße / dimensions	∅ / A	mm ²	12,4 / 120	17,5 / 240	8,7 / 60	6,2 / 30	26 / 76	6,2 / 30	8,7 / 60	12,4 / 120
Anzahl p. Rotor / number p. rotor		12	12	12	12	36	6	6	6	
Filterkarten / filter cards		1692	1691	1694	1693		[1] 1696	[1] 1697	[1] 1698	
Drehzahl / speed	RPM	4000	4000	4000	4000	4000	4000	4000	4000	
RZB / RCF		2039	2039	2039	2039	1914	1842	1842	1842	
Radius / radius	mm	114	114	114	114	107	103	103	103	
 (97%)	sec	22								
 1	sec	25								
Probenerwärmung/Sample temp. rise	K ¹⁾	8								

1) Probenerwärmung bei maximaler Drehzahl und 1 Stunde Laufzeit
 6) Objektträger nur belastbar bis RZB 1100
 [1] Einschritt-Methode

1) Sample temp. rise during maximum speed and 1 hour running time
 6) Object slide will not stand RCF values exceeding 1100
 [1] One-step method

1626		1661 + 1660		1648		1680				
Ausschwingrotor 6-fach / Swing out rotor 6-times  		 <hr/> 1470  <hr/> 1471 1475 		Ausschwingrotor 8-fach / Swing out rotor 8-times  		 <hr/> 1662  <hr/> 1671 1672 1673 				
Kapazität / capacity	ml	1 x 8		2 x 8		Kapazität / capacity	ml	[1] 0,5	[1] 0,5	[1] 0,5
Maße / dimensions Ø x L	mm	17,5 / 240	17,5 / 240	Maße / dimensions Ø x L	mm	6,2 / 30	8,7 / 60	12,4 / 120		
Anzahl p. Rotor / number p. rotor		6		6		Anzahl p. Rotor / number p. rotor		8		
Filterkarten / filter cards		---		---		Filterkarten / filter cards		[1] 1696	[1] 1697	[1] 1698
Drehzahl / speed	RPM	4000		4000		Drehzahl / speed	RPM	4000		
RZB / RCF		1950		1950		RZB / RCF		2218		
Radius / radius	mm	109		109		Radius / radius	mm	124	124	124
 (97%)	sec	22		22		 (97%)	sec	22		
 1	sec	25		25		 1	sec	28		
Probenerwärmung/Sample temp. rise	K ¹⁾	8		8		Probenerwärmung/Sample temp. rise	K ¹⁾	13		

- 1) Probenerwärmung bei maximaler Drehzahl und 1 Stunde Laufzeit
- 6) Objektträger nur belastbar bis RZB 1100
- [1] Einschritt-Methode

- 1) Sample temp. rise during maximum speed and 1 hour running time
- 6) Object slide will not stand RCF values exceeding 1100
- [1] One-step method